

Bath Collections **2022**





# GAMADecor



BY APPOINTMENT TO  
H.R.H. THE PRINCE OF WALES  
MANUFACTURER AND DISTRIBUTOR  
OF CERAMIC TILES AND BUILDING PRODUCTS.  
PORCELANOSA GROUP LIMITED

PORCELANOSA Grupo



## The power of a trademark.

PORCELANOSA Grupo is today a major reference on both the Spanish and international markets. Its consolidated position has been built up on values such as innovation and quality, but especially the trust placed in its large human capital, made up of almost 5,000 skilled professionals, and its concern for its stakeholders and environment.

PORCELANOSA Grupo has almost 40 years' experience and is present in almost 100 countries worldwide. This success is the result of a unique business model based on a strong corporate strategy. Today, the Group's eight companies offer a vast selection of products ranging from kitchen and bathroom equipment to state-of-the-art building solutions for contemporary architecture.

## Il potere di un marchio.

Il gruppo PORCELANOSA è oggi una società di riferimento nel mercato nazionale ed internazionale, fondata su valori come innovazione e qualità ma soprattutto basata sulla fiducia riposta nell'esteso comparto di risorse umane, quasi 5000 persone, e nell'attenzione ai valori sociali.

Con quasi 40 anni di esperienza, il Gruppo PORCELANOSA è presente in circa 100 paesi nel mondo, grazie a un modello di business irripetibile sul quale si appoggia una forte strategia imprenditoriale. Le otto società del Gruppo offrono un'estesa gamma di prodotti che comprendono non solo attrezzature per cucina o bagno ma anche soluzioni costruttive avanzate per l'architettura contemporanea.

## Сила бренда

Группа PORCELANOSA сегодня пользуется большим авторитетом как на испанском, так и на международном рынке. Пункта компании основаны на таких ценностях, как инновационное развитие, качество, тесное сотрудничество с партнерами, забота об окружающей среде и, что самое главное, на доверии к ее сотрудникам — в группе работает около 5000 высококвалифицированных специалистов.

Группа PORCELANOSA обладает почти 40-летним опытом и представлена без малого в 100 странах. Такой успех — результат применения уникальной бизнес-модели, в основе которой лежит сильная корпоративная стратегия. Сегодня восемь компаний Группы предлагают широкий ассортимент продукции: от кухонного и сантехнического оборудования до самых передовых разработок для современных архитектурных решений.



## Our philosophy.

GAMADecOR was founded in 1987 to produce top quality bathroom and kitchen furniture based on concepts of advanced design and technology. Based in Villarreal (Castellón), the company's facilities, which exceed 135,000 m<sup>2</sup>, are equipped with the very latest technology. We currently export to over fifty countries on all five continents and have our own showrooms in Spain, France, the UK, USA, Mexico, Italy and Portugal.

## La nostra filosofia.

GAMADecOR nasce del 1987 con l'obiettivo di offrire prodotti di alta qualità, tecnologia e design innovativo nella fabbricazione di mobili da bagno e cucina. Situata a Villarreal (Castellón), i nostri stabilimenti sono dotati delle più recenti soluzioni tecnologiche e occupano una superficie superiore a 135.000 m<sup>2</sup>. Attualmente esportiamo i nostri prodotti in più di cinquanta paesi dei cinque continenti con negozi di proprietà in Spagna, Francia, Regno Unito, Stati Uniti, Messico, Italia e Portogallo.

## Наша философия

Компания GAMADecOR была основана в 1987 году как предприятие по производству высококачественной мебели для ванных комнаты и кухни на основе концепций современного дизайна и передовых технологий. Предприятия компаний в городе Вильярреале (провинция Кастильон) расположены на площади свыше 135.000 м<sup>2</sup> и оснащены новейшим оборудованием. В настоящее время мы осуществляем экспортные поставки более чем в 50 стран на 5 континентах. У нас есть собственные демонстрационные залы в Испании, Франции, Великобритании, США, Мексике, Италии и Португалии.



<b>ITEM LEGEND</b>	<b>LEGENDA</b>	<b>LEGEND</b>	
WASH BASIN UNIT	BASE PORTALAVABO	ТУМБОЧКА ПОД УМЫВАЛЬНИК	<b>BP</b>
WALL MOUNTED WASH BASIN HOLDER	BASE PORTALAVABO SOSPESA	ТУМБОЧКА ПОД УМЫВАЛЬНИК	<b>BPS</b>
FLOOR-MOUNTED WASH BASIN HOLDER	BASE P. A TERRA	ТУМБОЧКА ПОД ВСТРОЕННЫЙ УМЫВАЛЬНИК	<b>BPT</b>
WALL MOUNTED MODULE	MODULO SOSPESO	ТУМБОЧКА ПОДВЕСНАЯ	<b>MS</b>
UPPER UNITS	MODULO PENSILE	ВЕРХНИЕ БЛОКИ	<b>MA</b>
TALL CABINET	MODULO COLONNA	ВЫСОКИЙ ШКАФ	<b>MC</b>
SPECIAL UNIT	MODULO SPECIALE	СПЕЦИАЛИЗИРОВАННЫЙ БЛОК	<b>ME</b>
DECORATIVE SIDE PANELLING	PANNELLI DECORATIVI	ДЕКОРАТИВНЫЕ БОКОВЫЕ ПАНЕЛИ	<b>TA</b>
ACCESSORIES	COMPLEMENTI	ДОПОЛНИТЕЛЬНЫЕ ПРИНАДЛЕЖНОСТИ	<b>CM</b>
WORKTOP	TOP	СТОЛЕШНИЦА	<b>EN</b>
BASIN UNIT	LAVABO	РАКОВИНА	<b>LA</b>
MIRROR	SPECCHIO	ЗЕРКАЛО	<b>ES</b>
WALL HUNG SHELF	RIPIANO A PARETE	НАСТЕННАЯ ПОЛКА	<b>FP</b>
RIGHT POSITION	POSIZIONE DESTRA	РАСПОЛОЖЕНИЕ СПРАВА	<b>DX</b>
LEFT POSITION	POSIZIONE SINISTRA	РАСПОЛОЖЕНИЕ СЛЕВА	<b>SX</b>
HANDLE	MANIGLIA	РУЧКЕ	
GAP	FORO	GAP	
COMPATIBLE UPC P-TRAP	COMPATIBILE SIFONE UPC	СОВМЕСТИМЫЙ СИФОН UPC	

highline

008

skyline

282

## Content

Play  
Stage  
Up  
Blind  
Side  
Last  
Mertens  
Duna  
Century  
Edge  
Icon  
Leaf  
Soft  
Dess  
Ciclo  
In  
**WORKTOPS**

Corner  
Fase  
Radio  
Gap  
Skill  
Hem  
Tuck  
Nut  
Bambu  
Urban  
Folk  
Travat  
Dock

Sets 378

Accessories 396







# highline

Play	010
Stage	024
Up	032
Blind	048
Side	056
Last	082
Mertens	132
Duna	140
Century	150
Edge	158
Icon	166
Leaf	186
Soft	198
Dess	210
Ciclo	238
In	256
<b>WORKTOPS</b>	<b>272</b>



The interpretation made in inches for the dimensions of the different items shown in the price list has been rounded to 1/8, however for a more accurate measurement please use millimetres or centimetres.

## Play

<b>EXTERIOR FINISHES</b> FINITURE ESTERNE ОТДЕЛКА ДЛЯ НАРУЖНОГО ИСПОЛЬЗОВАНИЯ	<input type="checkbox"/> Laminate Laminato ЛАМИНАТ	<input checked="" type="checkbox"/> Matt lacquer Laccato opaco МАТОВЫЙ ЛАК	<input checked="" type="checkbox"/> Wood veneer Legno ДЕРЕВО
	<input type="checkbox"/> HPL Stratificato СЛОИСТАЯ	<input checked="" type="checkbox"/> Gloss lacquer Laccato lucido ГЛЯНЦЕВЫЙ ЛАК	<input type="checkbox"/> Aluminium, Metal finish Alluminio, finitura Metal Алюминий, отделка Metal
<b>INTERIOR FINISHES</b> FINITURE INTERNE ОТДЕЛКА ДЛЯ ВНУТРЕННЕГО ИСПОЛЬЗОВАНИЯ	<input checked="" type="checkbox"/> Laminate Laminato ЛАМИНАТ	<input checked="" type="checkbox"/> Wood veneer Legno ДЕРЕВО	<input type="checkbox"/> Aluminium+laminated base Alluminio + base in laminato Алюминий + основа из ламината
	<input type="checkbox"/> Front handle Maniglia frontale a vista Декоративная передняя ручка	<input type="checkbox"/> Integrated metal handle Maniglia metallica integrata Встроенная металлическая ручка	<input checked="" type="checkbox"/> Integrated mechanized h. Maniglia integrata ricavata sul bordo Встроенная ручка по краю
<b>HANDLES</b> MANIGLIE РУЧКИ	<input type="checkbox"/> Push handle Maniglia Push РУЧКИ Push		
<b>TYPE OF UNITS</b> TIPI DI MODULI ТИПЫ МОДУЛЕЙ	<input checked="" type="checkbox"/> Compact Compatto Компактная	<input checked="" type="checkbox"/> Modular Modulare Модульная	
<b>POSITION</b> POSIZIONE ПОЗИЦИЯ	<input checked="" type="checkbox"/> Wall-mounted Sospeso Подвесная	<input checked="" type="checkbox"/> Floor-mounted A terra Напольная	
<b>MEASURES (CM)</b> DIMENSIONI РАЗМЕРЫ	◀ 60/ 90 / 120 23 <sup>5/8</sup> /35 <sup>3/8</sup> /47 <sup>1/4</sup>	▲ 22,8 / 66,2 9/26 <sup>1/8</sup>	↘ 48,7 19 <sup>1/8</sup>
<b>WORKTOP &amp; BASIN OPTIONS</b> OPZIONI TOP E LAVABI ВАРИАНТЫ СТОЛЕШНИЦ И УМЫВАЛЬНЫХ РАКОВИН	<input checked="" type="checkbox"/> Bath serie's worktop / basin Lavabo / top della serie Серийная умывальная раковина / столешница	<input type="checkbox"/> Standard worktops Top standard Стандартные столешницы	<input type="checkbox"/> Worktop + integrated basin Encimera + lavabo integrato Столешница + встроенная умывальная раковина
	<input checked="" type="checkbox"/> Over-mounted basin Lavabo da appoggio Настольная умывальная раковина	<input type="checkbox"/> Under-mounted basin Lavabo sottopiano Умывальная раковина, встраиваемая в столешницу снизу	<input type="checkbox"/> Double basin as option Opzione doppia vasca Вариант с двойной чашей
<b>WORKTOP FINISHES</b> FINITURE TOP ОТДЕЛКА СТОЛЕШНИЦ	<input type="checkbox"/> Krion® worktop Top in KRION® Столешница KRION®	<input type="checkbox"/> Gel Coat worktop Top in Gel Coat Столешница с покрытием гелькоут	<input type="checkbox"/> Natural Stone worktop Top in pietra naturale Столешница из натурального камня.
	<input type="checkbox"/> Glass worktop Top in vetro Столешница из стекла	<input checked="" type="checkbox"/> Bath furniture finish worktop Top con la finitura del mobile Столешница с той же отделкой, что и консоль/тумба	
<b>BASIN FINISHES</b> FINITURE LAVABI ОТДЕЛКА УМЫВАЛЬНЫХ РАКОВИН	<input type="checkbox"/> Krion® basin Lavabo in Krion® Умывальная раковина из Krion®	<input type="checkbox"/> Gel Coat basin Lavabo Gelcoat Раковина Gelcoat	<input checked="" type="checkbox"/> Ceramic basin Lavabo in ceramica Керамическая умывальная раковина
	<input type="checkbox"/> Natural Stone basin Lavabo in pietra naturale Умывальная раковина из натурального камня.		
<b>ACCESSORIES</b> ACCESSORI АКСЕССУАРЫ	<input type="checkbox"/> Mirror Specchio Зеркало	<input checked="" type="checkbox"/> Wall-mounted module Modulo sospeso Подвесной модуль	<input checked="" type="checkbox"/> Tall cabinet Modulo colonna Высокий шкаф
	<input checked="" type="checkbox"/> Upper unit Modulo alto Верхний модуль	<input type="checkbox"/> Organizer Organizzatore Органайзер	<input checked="" type="checkbox"/> Shelves Mensola Полка
			<input type="checkbox"/> Accessories Accessori Аксессуары

# play



This is a highly versatile option, with the possibility of a wall-hung washbasin or a basin fitted on top of the unit to simulate a pedestal in a choice of different sizes. Its auxiliary units can also be wall hung or supported by feet, offering a wide variety of customizable alternatives. As for its materials, it features an Xtone washbasin and a two-drawer bottom unit made of oak and Xtone for keeping the bathroom as neat as a new pin

Mobile da bagno particolarmente versatile in quanto il lavabo può essere sospeso a parete oppure posizionato sulla base, sulla falsariga di un mobile da bagno a forma di piedistallo disponibile in più dimensioni. Anche i moduli del mobile Play possono essere sospesi o posizionati sui piedini, il che rende possibile una vasta gamma di applicazioni nel progettare e configurare il mobile da bagno più adatto a noi. Quanto ai materiali, il mobile da bagno Play vanta un lavabo in Xtone, posto su base di rovere e Xtone con 2 cassetti, perfetta per tenere in ordine il nostro bagno.

Эта мебель для ванной отличается универсальным характером: раковину можно повесить на стене или поставить сверху на другой элемент, который может иметь разные размеры. Дополнительные модули Play также могут быть подвесными или на ножках, что открывает широкие возможности для создания мебели в соответствии с вашими вкусами и потребностями. Умывальная раковина выполнена из материала Xtone, а нижний элемент — из сочетания древесины дуба и Xtone. Внизу есть два ящика, благодаря которым вы сможете поддерживать в ванной идеальный порядок.



+info p.380

10008 Points  
PLAY Nylo Noir Pulido / Roble Torrefacto



+info p.380

13825 Points  
PLAY Liem Grey / Roble Polvo

**FINISHES**

GLOSS LACQUER / MATT LACQUER    LACCATO LUCIDO / LACCATO OPACO    ГЛЯНЦЕВЫЙ ЛАК / МАТОВЫЙ ЛАК



Ónix



Cromo



Férreo



Tórtola



Sílice



Bórax

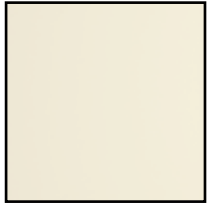

Cuarcita



Pizarra



Grafito

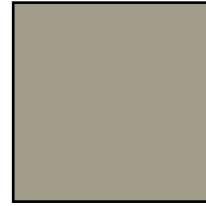

Plomo

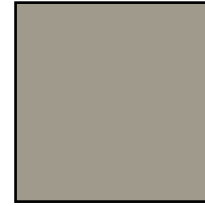

Limo



Pérgamon

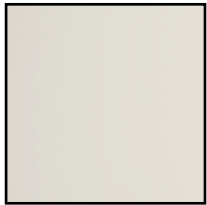

Alabastro

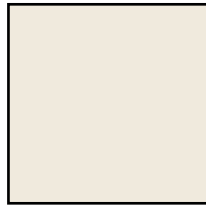

Porcelana



Negro Emotions



Ocean Blue



Azul Navy



Bottle



Orégano



Cúrcuma



Safrán



Curry



Blanco Snow



Blanco Emotions

**WOOD**

**LEGNO**

**ДЕРЕВО**



Roble Noche



Roble Cobre



Roble Bronce



Roble Sil



Roble Alba



Roble Torrefacto

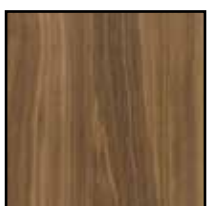

Nogal Seda

## FINISHES

WOOD

LEGNO

ДЕРЕВО

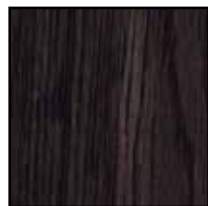

Roble Noche R.



Roble Cobre R.

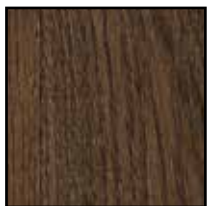

Roble Bronce R.

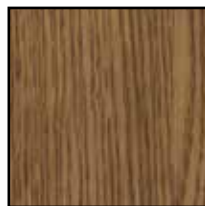

Roble Sil R.



Roble Alba R.

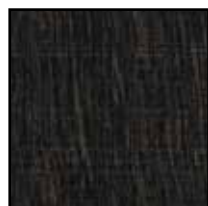

Roble Carbón R.

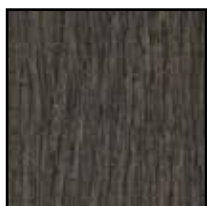

Roble Cuero R.



Roble Polvo R.



Roble Puro R.

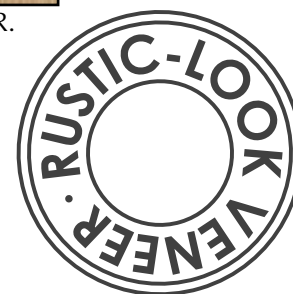

XTONE



Glem White



Paonazzo  
Biondo P.



Bottega  
Acero



Invisible  
White Pulido



Aged Clay



Liem Grey  
Nature



Aged Dark



Bottega  
Antracita



Liem Dark  
Nature



Nylo Noir  
Pulido

## XTONE

### FINISHES:

**G-2: Bottega Acero / Aged Clay / Aged Dark / Bottega Antracita.**

**G-3: Liem Grey Nature / Liem Dark Nature.**

**G-4: Glem White / Paonazzo Biondo Pulido / Invisible White Pulido / Nylo Noir Pulido.**



Glem White



Paonazzo Biondo P.



Bottega Acero



Invisible White Pulido



Aged Clay



Liem Grey Nature



Aged Dark



Bottega Antracita



Liem Dark Nature

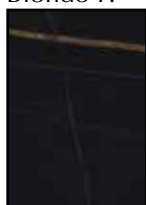

Nylo Noir Pulido

## LAVABO PLAY XTONE 60

DEPTH 48,7 CM / 19 1/8"

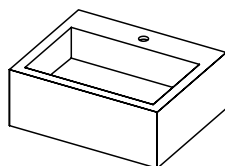

- Basin.
- Requires valve SAP 100104178 59P.
- Lavabo.
- Richiede valvola SAP 100104178 59P.
- Раковина.
- Требуется постоянный перелив SAP 100104178 59P.

MEASURES (LxWxD)	FINISHES	SAP	POINTS
60,2x22,8x48,7 / 23 3/4x9x19 1/8	G-2	700031503	3562
	G-3	700031504	3634
	G-4	700031505	3762

## LAVABO PLAY XTONE 90

DEPTH 48,7 CM / 19 1/8"

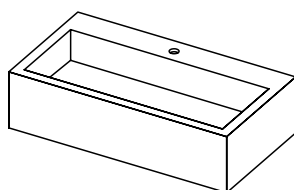

- Basin.
- Requires valve SAP 100104178 59P.
- Lavabo.
- Richiede valvola SAP 100104178 59P.
- Раковина.
- Требуется постоянный перелив SAP 100104178 59P.

MEASURES (LxWxD)	FINISHES	SAP	POINTS
90,2x22,8x48,7 / 35 1/2x9x19 1/8	G-2	700031506	4245
	G-3	700031507	4342
	G-4	700031508	4516



## LAVABO PLAY XTONE 120

DEPTH 48,7 CM / 19<sup>1</sup>/<sub>8</sub>"

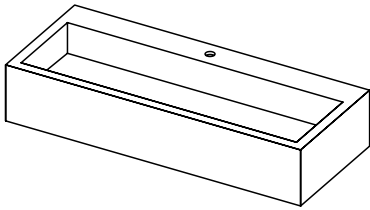

- Basin.
- Requires valve SAP 100104178 59P.
- Lavabo.
- Richiede valvola SAP 100104178 59P.
- Раковина.
- Требуется постоянный перелив SAP 100104178 59P.

MEASURES (LxWxD)	FINISHES	SAP	POINTS
120,2x22,8x48,7 / 47 <sup>3</sup> / <sub>8</sub> x9x19 <sup>1</sup> / <sub>8</sub>	G-2	700031500	4964
	G-3	700031501	5086
	G-4	700031502	5307

LA

## BPT XTONE

DEPTH 48 CM / 18<sup>7</sup>/<sub>8</sub>"

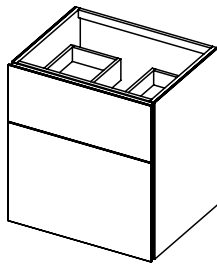

MEASURES (LxWxD)	FINISHES	SAP	POINTS
60x66,2x48,6 / 23 <sup>5</sup> / <sub>8</sub> x26 <sup>1</sup> / <sub>8</sub> x19 <sup>1</sup> / <sub>8</sub>	G-2	700031532	2253
	G-3	700031533	2309
	G-4	700031534	2410
90x66,2x48,6 / 35 <sup>3</sup> / <sub>8</sub> x26 <sup>1</sup> / <sub>8</sub> x19 <sup>1</sup> / <sub>8</sub>	G-2	700031551	2524
	G-3	700031552	2591
	G-4	700031553	2712
120x66,2x48,6 / 47 <sup>1</sup> / <sub>4</sub> x26 <sup>1</sup> / <sub>8</sub> x19 <sup>1</sup> / <sub>8</sub>	G-2	700031509	2788
	G-3	700031510	2866
	G-4	700031511	3007

BP

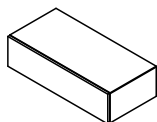

Wallmounted unit.

Modulo sospeso.

Тумба для ванной, монтируемая на стену.

MEASURES	(x↑x↓x↔)	FINISHES	SAP	POINTS
45x26x48,6 / 17 <sup>3</sup> / <sub>4</sub> x10 <sup>1</sup> / <sub>4</sub> x19 <sup>1</sup> / <sub>8</sub>		Gloss lacquer / G-2	700031520	1207
		Matt lacquer / G-2	700031523	1110
		Wood / G-2	700031526	1306
		Rustic-look wood / G-2	700031529	1438
		Gloss lacquer / G-3	700031521	1214
		Matt lacquer / G-3	700031524	1117
		Wood / G-3	700031527	1312
		Rustic-look wood / G-3	700031530	1445
		Gloss lacquer / G-4	700031522	1226
		Matt lacquer / G-4	700031525	1129
		Wood / G-4	700031528	1324
		Rustic-look wood / G-4	700031531	1457
60x26x48,6 / 23 <sup>5</sup> / <sub>8</sub> x10 <sup>1</sup> / <sub>4</sub> x19 <sup>1</sup> / <sub>8</sub>		Gloss lacquer / G-2	700031539	1305
		Matt lacquer / G-2	700031542	1195
		Wood / G-2	700031545	1402
		Rustic-look wood / G-2	700031548	1545
		Gloss lacquer / G-3	700031540	1314
		Matt lacquer / G-3	700031543	1204
		Wood / G-3	700031546	1411
		Rustic-look wood / G-3	700031549	1554
		Gloss lacquer / G-4	700031541	1329
		Matt lacquer / G-4	700031544	1220
		Wood / G-4	700031547	1427
		Rustic-look wood / G-4	700031550	1570
90x26x48,6 / 35 <sup>3</sup> / <sub>8</sub> x10 <sup>1</sup> / <sub>4</sub> x19 <sup>1</sup> / <sub>8</sub>		Gloss lacquer / G-2	700031554	1499
		Matt lacquer / G-2	700031557	1371
		Wood / G-2	700031560	1612
		Rustic-look wood / G-2	700031563	1779
		Gloss lacquer / G-3	700031555	1512
		Matt lacquer / G-3	700031558	1384
		Wood / G-3	700031561	1626
		Rustic-look wood / G-3	700031564	1792
		Gloss lacquer / G-4	700031556	1536
		Matt lacquer / G-4	700031559	1407
		Wood / G-4	700031562	1649
		Rustic-look wood / G-4	700031565	1816
120x26x48,6 / 47 <sup>1</sup> / <sub>4</sub> x10 <sup>1</sup> / <sub>4</sub> x19 <sup>1</sup> / <sub>8</sub>		Gloss lacquer / G-2	700031629	1693
		Matt lacquer / G-2	700031631	1542
		Wood / G-2	700030907	1807
		Rustic-look wood / G-2	700031630	1995
		Gloss lacquer / G-3	700031498	1711
		Matt lacquer / G-3	700030906	1560
		Wood / G-3	700031632	1825
		Rustic-look wood / G-3	700031488	2012
		Gloss lacquer / G-4	700030905	1742
		Matt lacquer / G-4	700031499	1591
		Wood / G-4	700031640	1856
		Rustic-look wood / G-4	700031497	2044

## EST PLAY

DEPTH 46 CM / 18<sup>1</sup>/<sub>8</sub>"

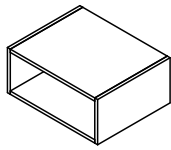

Shelf.  
Ripiano.  
Полка.

MEASURES	()	FINISHES	SAP	POINTS
30x26x46 / 11 <sup>3</sup> / <sub>4</sub> x10 <sup>1</sup> / <sub>4</sub> x18 <sup>1</sup> / <sub>8</sub>		Gloss lacquer	700031512	731
		Matt lacquer	700031513	595
		Wood	700031514	868
		Rustic-look wood	700031515	1045
45x26x46 / 17 <sup>3</sup> / <sub>4</sub> x10 <sup>1</sup> / <sub>4</sub> x18 <sup>1</sup> / <sub>8</sub>		Gloss lacquer	700031516	827
		Matt lacquer	700031517	664
		Wood	700031518	952
		Rustic-look wood	700031519	1151
60x26x46 / 23 <sup>5</sup> / <sub>8</sub> x10 <sup>1</sup> / <sub>4</sub> x18 <sup>1</sup> / <sub>8</sub>		Gloss lacquer	700031535	903
		Matt lacquer	700031536	712
		Wood	700031537	1041
		Rustic-look wood	700031538	1267

## LEG MS/EST

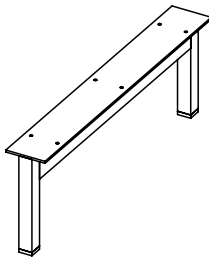

-Legs are optional.  
-Piedini opzionali.  
-Нога опциональная.

MEASURES	()	FINISHES	SAP	POINTS
2x15x44 / 0 <sup>3</sup> / <sub>4</sub> x5 <sup>7</sup> / <sub>8</sub> x17 <sup>3</sup> / <sub>8</sub>		Metal	100316729	209

## WALL UNIT

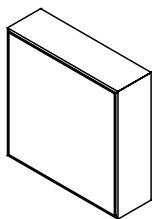

Wall unit with door.  
Modulo pensile con anta.  
Верхний блок с дверцей.

MEASURES		FINISHES	SAP	POINTS
45x48x18 / 17 <sup>3/4</sup> x18 <sup>7/8</sup> x7 <sup>1/8</sup>		Metal / G-2	700031596	762
		Metal / G-3	700031597	773
		Metal / G-4	700031598	792
45x60x18 / 17 <sup>3/4</sup> x23 <sup>5/8</sup> x7 <sup>1/8</sup>		Metal / G-2	700031602	833
		Metal / G-3	700031603	847
		Metal / G-4	700031604	871
60x60x18 / 23 <sup>5/8</sup> x23 <sup>5/8</sup> x7 <sup>1/8</sup>		Metal / G-2	700031611	953
		Metal / G-3	700031612	971
		Metal / G-4	700031613	1004

## WALL UNIT

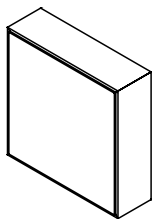

Wall unit with door.  
Modulo pensile con anta.  
Верхний блок с дверцей.

MEASURES		FINISHES	SAP	POINTS
45x48x18 / 17 <sup>3/4</sup> x18 <sup>7/8</sup> x7 <sup>1/8</sup>		Metal / G-2	700031599	801
		Metal / G-3	700031600	812
		Metal / G-4	700031601	832
60x48x18 / 23 <sup>5/8</sup> x18 <sup>7/8</sup> x7 <sup>1/8</sup>		Metal / G-2	700031608	896
		Metal / G-3	700031609	910
		Metal / G-4	700031610	937
90x48x18 / 35 <sup>3/8</sup> x18 <sup>7/8</sup> x7 <sup>1/8</sup>		Metal / G-2	700031617	1091
		Metal / G-3	700031618	1113
		Metal / G-4	700031619	1153
120x48x18 / 47 <sup>1/4</sup> x18 <sup>7/8</sup> x7 <sup>1/8</sup>		Metal / G-2	700031566	1280
		Metal / G-3	700031567	1310
		Metal / G-4	700031568	1364

## WALL UNIT

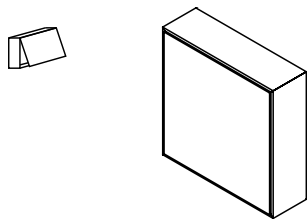

Wall unit with door.  
Modulo pensile con anta.  
Верхний блок с дверцей.

MEASURES	( x  x )	FINISHES	SAP	POINTS
45x60x18 / 17 <sup>3/4</sup> x23 <sup>5/8</sup> x7 <sup>1/8</sup>		Metal / G-2	700031605	873
		Metal / G-3	700031606	886
		Metal / G-4	700031607	911
60x60x18 / 23 <sup>5/8</sup> x23 <sup>5/8</sup> x7 <sup>1/8</sup>		Metal / G-2	700031614	987
		Metal / G-3	700031615	1006
		Metal / G-4	700031616	1039
90x60x18 / 35 <sup>3/8</sup> x23 <sup>5/8</sup> x7 <sup>1/8</sup>		Metal / G-2	700031620	1206
		Metal / G-3	700031621	1234
		Metal / G-4	700031622	1285

## SHELF

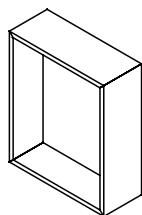

Shelf.  
Ripiano.  
Полка.

MEASURES	( x  x )	FINISHES	SAP	POINTS
45x36x12 / 17 <sup>3/4</sup> x14 <sup>1/8</sup> x4 <sup>3/4</sup>		Metal / G-2	700031590	444
		Metal / G-3	700031591	452
		Metal / G-4	700031592	467
45x48x12 / 17 <sup>3/4</sup> x18 <sup>7/8</sup> x4 <sup>3/4</sup>		Metal / G-2	700031593	496
		Metal / G-3	700031594	507
		Metal / G-4	700031595	527

## TALL CABINET MSC-2 WITHOUT FRONT

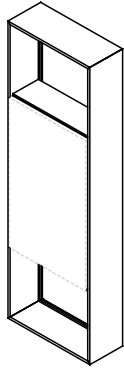

Tall cabinet. Front is required.  
 Colonna. Bisogna antina.  
 Высокий шкаф. Нуждается в фасаде.

MEASURES	(↔x↑□x↗)	FINISHES	SAP	POINTS
30x144x18 / 11 <sup>3/4</sup> x56 <sup>3/4</sup> x7 <sup>1/8</sup>		Metal / G-2	700031578	838
		Metal / G-3	700031579	860
		Metal / G-4	700031580	901
45x144x18 / 17 <sup>3/4</sup> x56 <sup>3/4</sup> x7 <sup>1/8</sup>		Metal / G-2	700031587	1010
		Metal / G-3	700031588	1044
		Metal / G-4	700031589	1107

## TALL CABINET FRONT MSC-2

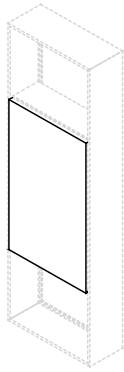

Column Front.  
 Porta colonna  
 Фасад высокого шкафа.

MEASURES	(↔x↑□x↗)	FINISHES	SAP	POINTS
30x73x2 / 11 <sup>3/4</sup> x28 <sup>3/4</sup> x0 <sup>3/4</sup>		Metal / G-2	700031623	442
		Metal / G-3	700031624	454
		Metal / G-4	700031625	474
45x73x2 / 17 <sup>3/4</sup> x28 <sup>3/4</sup> x0 <sup>3/4</sup>		Metal / G-2	700031626	534
		Metal / G-3	700031627	552
		Metal / G-4	700031628	584

## TALL CABINET MSC-1

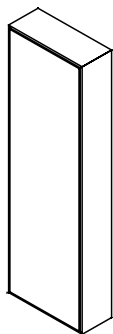

Tall cabinet push-to-open.  
Colonna apertura Push.  
Высокий шкаф с механизмом «нажал-открылось».

MEASURES	()	FINISHES	SAP	POINTS
30x144x18 / 11 <sup>3/4</sup> x56 <sup>3/4</sup> x7 <sup>1/8</sup>		Metal / G-2	700031575	1199
		Metal / G-3	700031576	1221
		Metal / G-4	700031577	1260
45x144x18 / 17 <sup>3/4</sup> x56 <sup>3/4</sup> x7 <sup>1/8</sup>		Metal / G-2	700031584	1439
		Metal / G-3	700031585	1473
		Metal / G-4	700031586	1534

## TALL CABINET ME

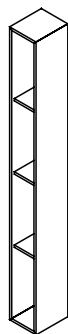

Tall cabinet.  
Colonna.  
Высокий шкаф.

MEASURES	()	FINISHES	SAP	POINTS
15x144x18 / 5 <sup>7/8</sup> x56 <sup>3/4</sup> x7 <sup>1/8</sup>		Metal / G-2	700031569	637
		Metal / G-3	700031570	647
		Metal / G-4	700031571	666
30x144x18 / 11 <sup>3/4</sup> x56 <sup>3/4</sup> x7 <sup>1/8</sup>		Metal / G-2	700031572	810
		Metal / G-3	700031573	833
		Metal / G-4	700031574	873
45x144x18 / 17 <sup>3/4</sup> x56 <sup>3/4</sup> x7 <sup>1/8</sup>		Metal / G-2	700031581	982
		Metal / G-3	700031582	1017
		Metal / G-4	700031583	1079



- + OPTIONS FOR DESS / ICONS SERIES FINISHING
- + OPZIONI DI FINITURE PER LE SERIE DESS / ICON
- + ДОПОЛНИТЕЛЬНЫЕ ВАРИАНТЫ ОТДЕЛКИ В СЕРИИ DESS / ICON



The interpretation made in inches for the dimensions of the different items shown in the price list has been rounded to 1/8, however for a more accurate measurement please use millimetres or centimetres.

## Stage

<b>EXTERIOR FINISHES</b> FINITURE ESTERNE ОТДЕЛКА ДЛЯ НАРУЖНОГО ИСПОЛЬЗОВАНИЯ	<input type="checkbox"/> Laminate Laminato ЛАМИНАТ	<input checked="" type="checkbox"/> Matt lacquer Laccato opaco МАТОВЫЙ ЛАК	<input checked="" type="checkbox"/> Wood veneer Legno ДЕРЕВО
	<input type="checkbox"/> HPL Stratificato СЛОИСТАЯ	<input type="checkbox"/> Gloss lacquer Laccato lucido ГЛЯНЦЕВЫЙ ЛАК	<input type="checkbox"/> Aluminium, Metal finish Alluminio, finitura Metal Алюминий, отделка Metal
<b>INTERIOR FINISHES</b> FINITURE INTERNE ОТДЕЛКА ДЛЯ ВНУТРЕННЕГО ИСПОЛЬЗОВАНИЯ	<input type="checkbox"/> Laminate Laminato ЛАМИНАТ	<input checked="" type="checkbox"/> Wood veneer Legno ДЕРЕВО	<input type="checkbox"/> Aluminium+laminated base Alluminio + base in laminato Алюминий + основа из ламината
	<input checked="" type="checkbox"/> Front handle Maniglia frontale a vista Декоративная передняя ручка	<input type="checkbox"/> Integrated metal handle Maniglia metallica integrata Встроенная металлическая ручка	<input type="checkbox"/> Integrated mechanized h. Maniglia integrata ricavata sul bordo Встроенная ручка по краю
<b>HANDLES</b> MANIGLIE РУЧКИ	<input type="checkbox"/> Push handle Maniglia Push РУЧКИ Push		
<b>TYPE OF UNITS</b> TIPI DI MODULI ТИПЫ МОДУЛЕЙ	<input checked="" type="checkbox"/> Compact Compatto Компактная	<input type="checkbox"/> Modular Modulare Модульная	
<b>POSITION</b> POSIZIONE ПОЗИЦИЯ	<input checked="" type="checkbox"/> Wall-mounted Sospeso Подвесная	<input type="checkbox"/> Floor-mounted A terra Напольная	
<b>MEASURES (CM)</b> DIMENSIONI РАЗМЕРЫ	◀ 61 / 81 / 121 24/31 <sup>7/8</sup> /47 <sup>5/8</sup>	▲ 52 20 <sup>1/2</sup>	▶ 51 20 <sup>1/8</sup>
<b>WORKTOP &amp; BASIN OPTIONS</b> OPZIONI TOP E LAVABI ВАРИАНТЫ СТОЛЕШНИЦ И УМЫВАЛЬНЫХ РАКОВИН	<input checked="" type="checkbox"/> Bath serie's worktop / basin Lavabo / top della serie Серийная умывальная раковина / столешница	<input type="checkbox"/> Standard worktops Top standard Стандартные столешницы	<input type="checkbox"/> Worktop + integrated basin Encimera + lavabo integrato Столешница + встроенная умывальная раковина
	<input checked="" type="checkbox"/> Over-mounted basin Lavabo da appoggio Настольная умывальная раковина	<input type="checkbox"/> Under-mounted basin Lavabo sottopiano Умывальная раковина, встраиваемая в столешницу снизу	<input type="checkbox"/> Double basin as option Opzione doppia vasca Вариант с двойной чашей
<b>WORKTOP FINISHES</b> FINITURE TOP ОТДЕЛКА СТОЛЕШНИЦ	<input checked="" type="checkbox"/> Krion® worktop Top in KRION® Столешница KRION®	<input type="checkbox"/> Gel Coat worktop Top in Gel Coat Столешница с покрытием гелькоут	<input type="checkbox"/> Natural Stone worktop Top in pietra naturale Столешница из натурального камня.
	<input type="checkbox"/> Glass worktop Top in vetro Столешница из стекла	<input type="checkbox"/> Bath furniture finish worktop Top con la finitura del mobile Столешница с той же отделкой, что и консоль/тумба	
<b>BASIN FINISHES</b> FINITURE LAVABI ОТДЕЛКА УМЫВАЛЬНЫХ РАКОВИН	<input checked="" type="checkbox"/> Krion® basin Lavabo in Krion® Умывальная раковина из Krion®	<input type="checkbox"/> Gel Coat basin Lavabo Gelcoat Раковина Gelcoat	<input type="checkbox"/> Ceramic basin Lavabo in ceramica Керамическая умывальная раковина
	<input type="checkbox"/> Natural Stone basin Lavabo in pietra naturale Умывальная раковина из натурального камня.		
<b>ACCESSORIES</b> ACCESSORI АКСЕССУАРЫ	<input checked="" type="checkbox"/> Mirror Specchio Зеркало	<input type="checkbox"/> Wall-mounted module Modulo sospeso Подвесной модуль	<input type="checkbox"/> Tall cabinet Modulo colonna Высокий шкаф
	<input type="checkbox"/> Upper unit Modulo alto Верхний модуль	<input type="checkbox"/> Organizer Organizzatore Органайзер	<input type="checkbox"/> Shelves Mensola Полка
			<input type="checkbox"/> Accessories Accessori Аксессуары



# stage



Stage is a modern take on vintage bathroom units. It is neo-classical in style, with a mix of materials that include oak and Krion. One of its star features is the Krion countertop, with a skirt with tubular reliefs. It stands on rounded feet typical of 1900s furniture, with two inner drawers to keep the bathroom neat and tidy.

Stage è un mobile da bagno in stile neoclassico rivisitato in chiave moderna il cui design vanta materiali diversi come il rovere e il Krion. Tra le caratteristiche salienti spicca il piano in Krion con pannello laterale e frontale a rilievo e piedini arrotondati sulla falsariga dei mobili del 1900. È munito anche di due cassetti interni per organizzare al meglio il nostro bagno.

В мебели для ванной Stage чувствуется дух ретро, и вместе с тем она создана для современного дома. Это неоклассическая мебель, сочетающая в себе такие разные материалы, как древесина дуба и Krion. В число ее наиболее ярких особенностей входят столешница из материала Krion с рельефными деталями на вертикальных поверхностях и закругленные ножки, напоминающие мебель прошлого века. Здесь есть также два внутренних ящика, благодаря которым можно организованно хранить в ванной комнате различные предметы.



+info p.380



**19018 Points**  
**STAGE Tórtola Mate**

# FINISHES

MATT LACQUER

LACCATO OPACO

МАТОВЫЙ ЛАК



Ónix



Cromo



Férreo



Tórtola



Sílice

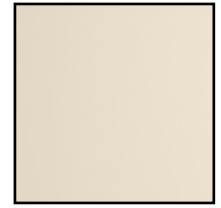

Bórax

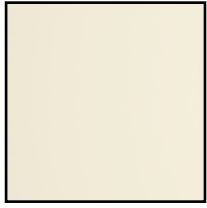

Cuarcita



Pizarra



Grafito

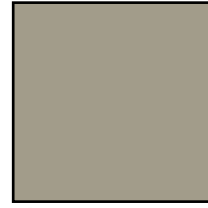

Plomo



Limo



Pérgamon

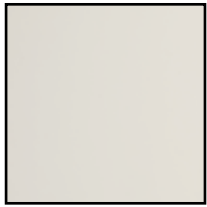

Alabastro

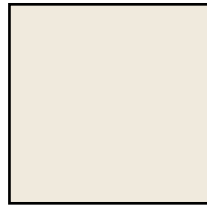

Porcelana



Negro Emotions



Ocean Blue



Azul Navy



Bottle

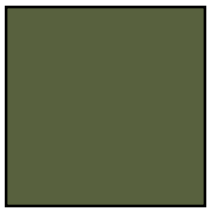

Orégano



Cúrcuma



Safrán



Curry



Blanco Snow



Blanco Emotions

WOOD

LEGNO

ДЕРЕВО



Roble Noche

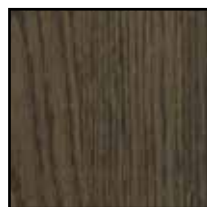

Roble Cobre



Roble Bronce



Roble Sil



Roble Alba

## WASH BASIN UNIT BPS

DEPTH 51CM / 20<sup>1/8"</sup>

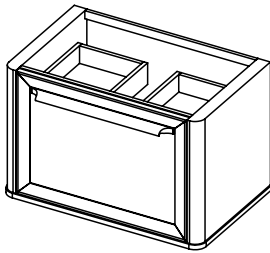

Wash basin unit.

Basi portalavabo

Тумбочка под умывальник.



MEASURES (x x x)	FINISHES	SAP	POINTS
61x52x51 / 24x20 <sup>1/2</sup> x20 <sup>1/8</sup>		700031494	4636
81x52x51 / 31 <sup>7/8</sup> x20 <sup>1/2</sup> x20 <sup>1/8</sup>	Matt lacquer / Wood	700031107	5049
121x52x51 / 47 <sup>5/8</sup> x20 <sup>1/2</sup> x20 <sup>1/8</sup>		700031485	5914

## LEG

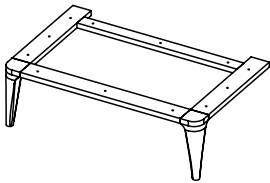

-Legs are optional.

-Piedini opzionali.

-Нога опциональная.

MEASURES (x x x)	FINISHES	SAP	POINTS
60x23,9x50,2 / 23 <sup>5/8</sup> x9 <sup>3/8</sup> x19 <sup>3/4</sup>		700030903	1006
80x23,9x50,2 / 31 <sup>1/2</sup> x9 <sup>3/8</sup> x19 <sup>3/4</sup>	Matt lacquer / Wood	700030904	1046
120x23,9x50,2 / 47 <sup>1/4</sup> x9 <sup>3/8</sup> x19 <sup>3/4</sup>		700031104	1131

# stage

## STAGE BASIN KRION 60

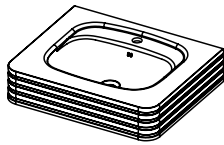

- Basin.
- Requires valve SAP100174610 112P.**
- Lavabo.
- Richiede valvola SAP100174610 112P.**
- Раковина.
- Требуется постоянный перелив SAP100174610 112P.

MEASURES		FINISHES	SAP	POINTS
61x13,2x51	/ 24x5 <sup>1/4</sup> x20 <sup>1/8</sup>	Krion	100316560	2004

## STAGE BASIN KRION 80

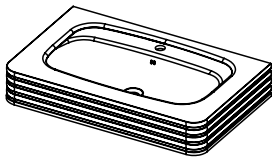

- Basin.
- Requires valve SAP100174610 112P.**
- Lavabo.
- Richiede valvola SAP100174610 112P.**
- Раковина.
- Требуется постоянный перелив SAP100174610 112P.

MEASURES		FINISHES	SAP	POINTS
81x13,2x51	/ 31 <sup>7/8</sup> x5 <sup>1/4</sup> x20 <sup>1/8</sup>	Krion	100316561	2364

## STAGE BASIN KRION 120

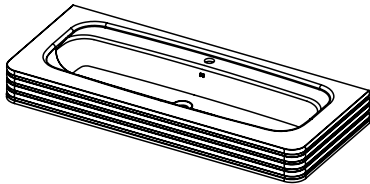

- Basin.
- Requires valve SAP100174610 112P.**
- Lavabo.
- Richiede valvola SAP100174610 112P.**
- Раковина.
- Требуется постоянный перелив SAP100174610 112P.

MEASURES		FINISHES	SAP	POINTS
121x13,2x51	/ 47 <sup>5/8</sup> x5 <sup>1/4</sup> x20 <sup>1/8</sup>	Krion	100316509	2972

## STAGE MIRROR

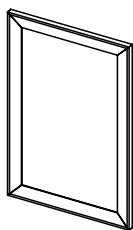

- Mirror w/o light.
- Specchio senza illuminazione.
- Зеркало без подсветки.

MEASURES	(xx)	FINISHES	SAP	POINTS
49,5x74,6x2,5 / 19 <sup>1/2</sup> x29 <sup>3/8</sup> x1			700031108	930
69,5x74,6x2,5 / 27 <sup>3/8</sup> x29 <sup>3/8</sup> x1		Matt lacquer / Wood	700031105	1050
109,5x74,6x2,5 / 43 <sup>1/8</sup> x29 <sup>3/8</sup> x1			700031495	1268

## STAGE MIRROR

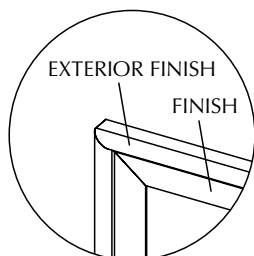
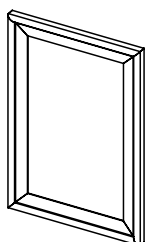

- Mirror w/o light.
- Specchio senza illuminazione.
- Зеркало без подсветки.

MEASURES	(xx)	FINISHES	EXTERIOR FINISHES	SAP	POINTS
54x79x4 / 21 <sup>1/4</sup> x31 <sup>1/8</sup> x1 <sup>5/8</sup>				700031484	1844
74x79x4 / 29 <sup>1/8</sup> x31 <sup>1/8</sup> x1 <sup>5/8</sup>		Matt lacquer / Wood	Matt lacquer / Wood	700031106	2015
114x79x4 / 44 <sup>7/8</sup> x31 <sup>1/8</sup> x1 <sup>5/8</sup>				700031496	2390



The interpretation made in inches for the dimensions of the different items shown in the price list has been rounded to 1/8, however for a more accurate measurement please use millimetres or centimetres.

## Up

<b>EXTERIOR FINISHES</b> FINITURE ESTERNE ОТДЕЛКА ДЛЯ НАРУЖНОГО ИСПОЛЬЗОВАНИЯ	<input type="checkbox"/> Laminate Laminato ЛАМИНАТ	<input checked="" type="checkbox"/> Matt lacquer Laccato opaco МАТОВЫЙ ЛАК	<input checked="" type="checkbox"/> Wood veneer Legno ДЕРЕВО
	<input type="checkbox"/> HPL Stratificato СЛОИСТАЯ	<input checked="" type="checkbox"/> Gloss lacquer Laccato lucido ГЛЯНЦЕВЫЙ ЛАК	<input type="checkbox"/> Aluminium, Metal finish Alluminio, finitura Metal Алюминий, отделка Metal
<b>INTERIOR FINISHES</b> FINITURE INTERNE ОТДЕЛКА ДЛЯ ВНУТРЕННЕГО ИСПОЛЬЗОВАНИЯ	<input checked="" type="checkbox"/> Laminate Laminato ЛАМИНАТ	<input type="checkbox"/> Wood veneer Legno ДЕРЕВО	<input type="checkbox"/> Aluminium+laminated base Alluminio + base in laminato Алюминий + основа из ламината
	<input type="checkbox"/> Front handle Maniglia frontale a vista Декоративная передняя ручка	<input type="checkbox"/> Integrated metal handle Maniglia metallica integrata Встроенная металлическая ручка	<input checked="" type="checkbox"/> Integrated mechanized h. Maniglia integrata ricavata sul bordo Встроенная ручка по краю
<b>HANDLES</b> MANIGLIE РУЧКИ	<input type="checkbox"/> Push handle Maniglia Push РУЧКИ Push		
<b>TYPE OF UNITS</b> TIPI DI MODULI ТИПЫ МОДУЛЕЙ	<input checked="" type="checkbox"/> Compact Compatto Компактная	<input checked="" type="checkbox"/> Modular Modulare Модульная	
<b>POSITION</b> POSIZIONE ПОЗИЦИЯ	<input checked="" type="checkbox"/> Wall-mounted Sospeso Подвесная	<input type="checkbox"/> Floor-mounted A terra Напольная	
<b>MEASURES (CM)</b> DIMENSIONI РАЗМЕРЫ	◀ 60 / 80 / 90 / 100 / 120 23 <sup>5/8</sup> / 31 <sup>1/2</sup> / 35 <sup>3/8</sup> / 39 <sup>3/8</sup> / 47 <sup>1/4</sup>	52 20 <sup>1/2</sup>	▶ 48 18 <sup>7/8</sup>
<b>WORKTOP &amp; BASIN OPTIONS</b> OPZIONI TOP E LAVABI ВАРИАНТЫ СТОЛЕШНИЦ И УМЫВАЛЬНЫХ РАКОВИН	<input type="checkbox"/> Bath serie's worktop / basin Lavabo / top della serie Серийная умывальная раковина / столешница	<input checked="" type="checkbox"/> Standard worktops Top standard Стандартные столешницы	<input checked="" type="checkbox"/> Worktop + integrated basin Encimera + lavabo integrato Столешница + встроенная умывальная раковина
	<input checked="" type="checkbox"/> Over-mounted basin Lavabo da appoggio Настольная умывальная раковина	<input checked="" type="checkbox"/> Under-mounted basin Lavabo sottopiano Умывальная раковина, встраиваемая в столешницу снизу	<input checked="" type="checkbox"/> Double basin as option Opzione doppia vasca Вариант с двойной чашей
<b>WORKTOP FINISHES</b> FINITURE TOP ОТДЕЛКА СТОЛЕШНИЦ	<input checked="" type="checkbox"/> Krion® worktop Top in KRION® Столешница KRION®	<input checked="" type="checkbox"/> Gel Coat worktop Top in Gel Coat Столешница с покрытием гелькоут	<input checked="" type="checkbox"/> Natural Stone worktop Top in pietra naturale Столешница из натурального камня.
	<input type="checkbox"/> Glass worktop Top in vetro Столешница из стекла	<input type="checkbox"/> Bath furniture finish worktop Top con la finitura del mobile Столешница с той же отделкой, что и консоль/тумба	
<b>BASIN FINISHES</b> FINITURE LAVABI ОТДЕЛКА УМЫВАЛЬНЫХ РАКОВИН	<input checked="" type="checkbox"/> Krion® basin Lavabo in Krion® Умывальная раковина из Krion®	<input checked="" type="checkbox"/> Gel Coat basin Lavabo Gelcoat Раковина Gelcoat	<input checked="" type="checkbox"/> Ceramic basin Lavabo in ceramica Керамическая умывальная раковина
	<input type="checkbox"/> Natural Stone basin Lavabo in pietra naturale Умывальная раковина из натурального камня.		
<b>ACCESSORIES</b> ACCESSORI АКСЕССУАРЫ	<input type="checkbox"/> Mirror Specchio Зеркало	<input type="checkbox"/> Wall-mounted module Modulo sospeso Подвесной модуль	<input checked="" type="checkbox"/> Tall cabinet Modulo colonna Высокий шкаф
	<input type="checkbox"/> Upper unit Modulo alto Верхний модуль	<input type="checkbox"/> Organizer Organizzatore Органайзер	<input type="checkbox"/> Shelves Mensola Полка
			<input type="checkbox"/> Accessories Accessori Аксессуары



## up



A bathroom unit with an unpretentious design, conceived to bring a lightweight feel to its robust structure through slender contours that spark off volumetric interplay. Up also stands out for its exquisite interiors, in keeping with the rest of the design, without relinquishing functionality, given its high storage space and the possibility of additional space in its wall-hung cabinets. Thanks to its varying sizes and wide variety of finishes, this is a unit perfect for bathrooms of all kinds.

Un mobile da bagno dalle linee semplici, che riesce ad alleggerire questo design robusto giocando con i volumi grazie al contorno sottile. Un design che non trascurava la praticità, dato che questo mobile presenta una grande capacità, che si può aumentare con gli armadi a parete. Un mobile che si inserisce perfettamente in qualsiasi tipo di bagno grazie alle dimensioni diverse e alla gran varietà di finiture, oltre agli interni molto curati alla pari di tutto il mobile.

Тумба для ванной комнаты с лаконичными линиями, в которой достигается необычная для подобных предметов мебели легкость, при этом утонченные контуры создают особую игру объемов. Дизайн идет здесь рука об руку с практичностью: в тумбе предусмотрено много места для хранения. Кроме того, к ней можно добавить подходящие настенные шкафы. Благодаря различным размерным вариантам и видам отделки эта мебель органично впишется в ванную комнату любого типа. Внутренняя часть тщательно продумана и созвучна общему виду изделия.



2844 Points  
UP alabastro mate

+info p.380



+info p.381

9411 Points  
UP blanco snow mate



+info p.381

9771 Points  
UP roble puro

## FINISHES

GLOSS LACQUER / MATT LACQUER    LACCATO LUCIDO / LACCATO OPACO    ГЛЯНЦЕВЫЙ ЛАК / МАТОВЫЙ ЛАК



Ónix



Cromo

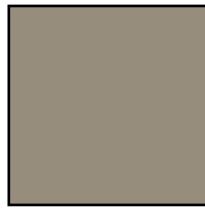

Férreo



Tórtola



Sílice



Bórax

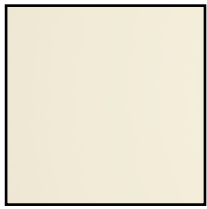

Cuarcita



Pizarra



Grafito

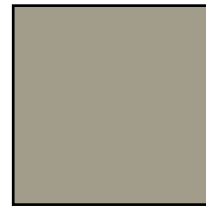

Plomo

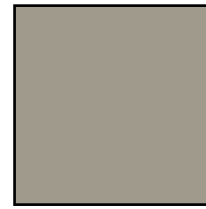

Limo



Pérgamon

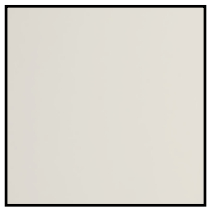

Alabastro

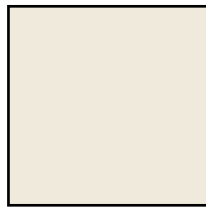

Porcelana



Negro Emotions



Ocean Blue



Azul Navy



Bottle

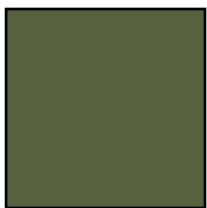

Orégano



Cúrcuma



Safrán



Curry



Blanco Snow

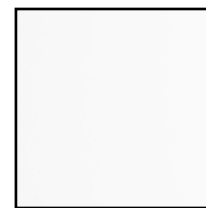

Blanco Emotions

## WOOD

## LEGNO

## ДЕРЕВО



Roble Noche



Roble Cobre



Roble Bronce



Roble Sil



Roble Alba



Roble Torrefacto

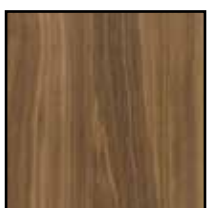

Nogal Seda

## FINISHES

WOOD

LEGNO

ДЕРЕВО

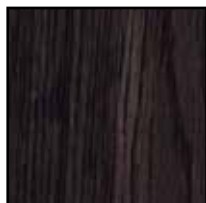

Roble Noche R.



Roble Cobre R.

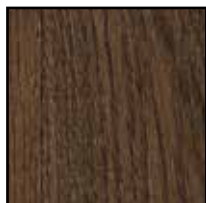

Roble Bronce R.

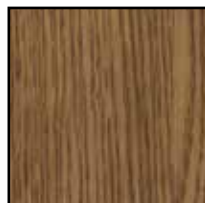

Roble Sil R.

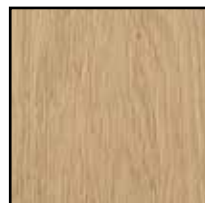

Roble Alba R.



Roble Carbón R.

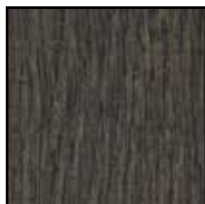

Roble Cuero R.

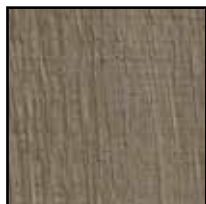

Roble Polvo R.

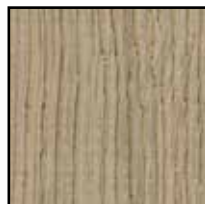

Roble Puro R.

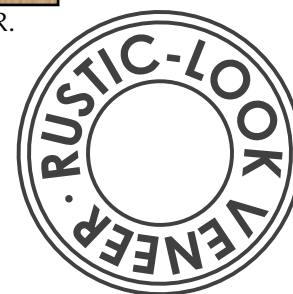

WORKTOPS

TOP

СТОЛЕШНИЦЫ

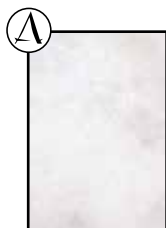

Arctic White



Via Lactea



Mármol Carrara



M. Blanco Ibiza



Granito Portobello

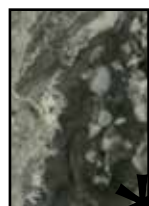

Arabescato Orobico



G. Negro Tanzania M.



Granito Len

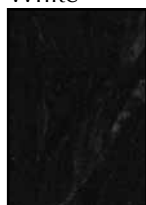

Barocco Vintage

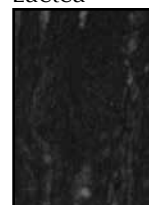

Cheyenne Vintage



Amarula Vintage

\* Maximum length recommended 120 cm. / 47<sup>1</sup>/<sub>4</sub>"

\* Lunghezza massima raccomandata 120 cm. / 47<sup>1</sup>/<sub>4</sub>"

\* Рекомендуемая максимальная длина — 120 см / 47<sup>1</sup>/<sub>4</sub>"

WASH BASIN UNIT BPS-1C

DEPTH 48 CM / 18<sup>7</sup>/<sub>8</sub>"

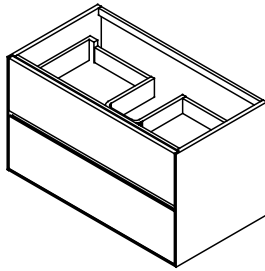

Full basin unit.

Base portalavabo **completa**.

Тумбочка под умывальник полностью.

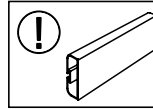

SPACER REQUIRED.  
AGGIUNGERE PROFILO DI SEPARAZIONE.  
НУЖДАЕТСЯ В ПРОФИЛЕ.

MEASURES (±x±x±x)	FINISHES	BASIN	SAP	POINTS
60x52x48 / 23 <sup>5</sup> / <sub>8</sub> x20 <sup>1</sup> / <sub>2</sub> x18 <sup>7</sup> / <sub>8</sub>	Gloss lacquer	CENTERED	700029743	1926
	Matt lacquer		700029742	1763
	Wood		700029740	2141
	Rustic-look wood		700029741	2401
80x52x48 / 31 <sup>1</sup> / <sub>2</sub> x20 <sup>1</sup> / <sub>2</sub> x18 <sup>7</sup> / <sub>8</sub>	Gloss lacquer	CENTERED / SX	700029755	2113
	Matt lacquer		700029754	1913
	Wood		700029752	2321
	Rustic-look wood		700029753	2618
90x52x48 / 35 <sup>3</sup> / <sub>8</sub> x20 <sup>1</sup> / <sub>2</sub> x18 <sup>7</sup> / <sub>8</sub>	Gloss lacquer	CENTERED	700029767	2218
	Matt lacquer		700029766	2000
	Wood		700029764	2414
	Rustic-look wood		700029765	2727
100x52x48 / 39 <sup>3</sup> / <sub>8</sub> x20 <sup>1</sup> / <sub>2</sub> x18 <sup>7</sup> / <sub>8</sub>	Gloss lacquer	CENTERED	700029779	2323
	Matt lacquer		700029778	2087
	Wood		700029776	2501
	Rustic-look wood		700029777	2832
120x52x48 / 47 <sup>1</sup> / <sub>4</sub> x20 <sup>1</sup> / <sub>2</sub> x18 <sup>7</sup> / <sub>8</sub>	Gloss lacquer	CENTERED / DX / SX	700029791	2521
	Matt lacquer		700029790	2249
	Wood		700029788	2670
	Rustic-look wood		700029789	3036

WASH BASIN UNIT BPS-1C D/S

DEPTH 48 CM / 18<sup>7</sup>/<sub>8</sub>"

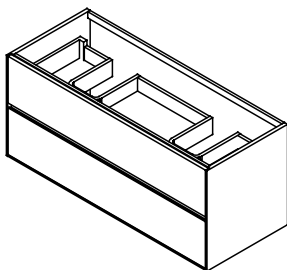

Full basin unit.

Base portalavabo **completa**.

Тумбочка под умывальник полностью.

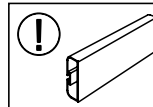

SPACER REQUIRED.  
AGGIUNGERE PROFILO DI SEPARAZIONE.  
НУЖДАЕТСЯ В ПРОФИЛЕ.

MEASURES (±x±x±x)	FINISHES	BASIN	SAP	POINTS
120x52x48 / 47 <sup>1</sup> / <sub>4</sub> x20 <sup>1</sup> / <sub>2</sub> x18 <sup>7</sup> / <sub>8</sub>	Gloss lacquer	D/S	700029803	2553
	Matt lacquer		700029802	2281
	Wood		700029800	2702
	Rustic-look wood		700029801	3067

## WASH BASIN UNIT BPS DX

DEPTH 48 CM / 18<sup>7</sup>/<sub>8</sub>"

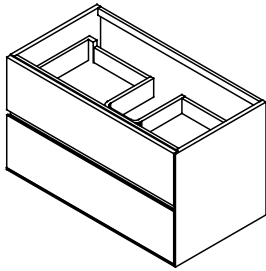

Basin unit with **NO** left side.

Base portalavabo **SENZA** spalla sinistra.

Тумбочка под умывальник БЕЗ левой боковой стороны.

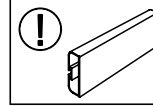

SPACER REQUIRED.

AGGIUNGERE PROFILO DI SEPARAZIONE.

НУЖДАЕТСЯ В ПРОФИЛЕ.

MEASURES (x x x)	FINISHES	BASIN	SAP	POINTS
60x52x48 / 23 <sup>5</sup> / <sub>8</sub> x20 <sup>1</sup> / <sub>2</sub> x18 <sup>7</sup> / <sub>8</sub>	Gloss lacquer	CENTERED	700029747	1803
	Matt lacquer		700029746	1626
	Wood		700029744	1999
	Rustic-look wood		700029745	2196
80x52x48 / 31 <sup>1</sup> / <sub>2</sub> x20 <sup>1</sup> / <sub>2</sub> x18 <sup>7</sup> / <sub>8</sub>	Gloss lacquer	CENTERED / SX	700029759	1990
	Matt lacquer		700029758	1776
	Wood		700029756	2179
	Rustic-look wood		700029757	2413
90x52x48 / 35 <sup>3</sup> / <sub>8</sub> x20 <sup>1</sup> / <sub>2</sub> x18 <sup>7</sup> / <sub>8</sub>	Gloss lacquer	CENTERED	700029771	2095
	Matt lacquer		700029770	1863
	Wood		700029768	2271
	Rustic-look wood		700029769	2523
100x52x48 / 39 <sup>3</sup> / <sub>8</sub> x20 <sup>1</sup> / <sub>2</sub> x18 <sup>7</sup> / <sub>8</sub>	Gloss lacquer	CENTERED	700029783	2200
	Matt lacquer		700029782	1950
	Wood		700029780	2359
	Rustic-look wood		700029781	2628
120x52x48 / 47 <sup>1</sup> / <sub>4</sub> x20 <sup>1</sup> / <sub>2</sub> x18 <sup>7</sup> / <sub>8</sub>	Gloss lacquer	CENTERED / DX / SX	700029795	2398
	Matt lacquer		700029794	2112
	Wood		700029792	2528
	Rustic-look wood		700029793	2831

## WASH BASIN UNIT BPS-1 DX D/S

DEPTH 48 CM / 18<sup>7</sup>/<sub>8</sub>"

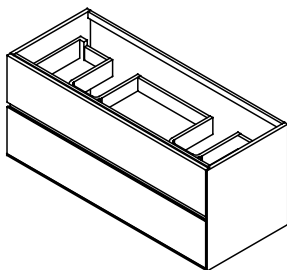

Basin unit with **NO** left side.

Base portalavabo **SENZA** spalla sinistra.

Тумбочка под умывальник БЕЗ левой боковой стороны.

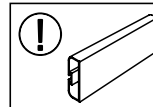

SPACER REQUIRED.

AGGIUNGERE PROFILO DI SEPARAZIONE.

НУЖДАЕТСЯ В ПРОФИЛЕ.

MEASURES (x x x)	FINISHES	BASIN	SAP	POINTS
120x52x48 / 47 <sup>1</sup> / <sub>4</sub> x20 <sup>1</sup> / <sub>2</sub> x18 <sup>7</sup> / <sub>8</sub>	Gloss lacquer	D/S	700029807	2430
	Matt lacquer		700029806	2144
	Wood		700029804	2559
	Rustic-look wood		700029805	2863

WASH BASIN UNIT SX

DEPTH 48 CM / 18<sup>7</sup>/<sub>8</sub>"

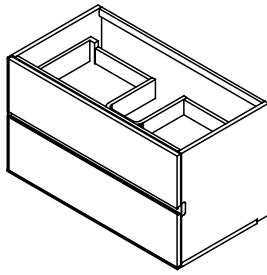

Basin unit with **NO** right side.

Base portalavabo **SENZA** spalla destra.

Тумбочка под умывальник БЕЗ правой боковой стороны.

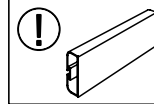

SPACER REQUIRED.  
AGGIUNGERE PROFILO DI SEPARAZIONE.  
НУЖДАЕТСЯ В ПРОФИЛЕ.

MEASURES (±x±x±)	FINISHES	BASIN	SAP	POINTS
60x52x48 / 23 <sup>5</sup> / <sub>8</sub> x20 <sup>1</sup> / <sub>2</sub> x18 <sup>7</sup> / <sub>8</sub>	Gloss lacquer	CENTERED	700029751	1803
	Matt lacquer		700029750	1626
	Wood		700029748	1999
	Rustic-look wood		700029749	2196
80x52x48 / 31 <sup>1</sup> / <sub>2</sub> x20 <sup>1</sup> / <sub>2</sub> x18 <sup>7</sup> / <sub>8</sub>	Gloss lacquer	CENTERED / SX	700029763	1990
	Matt lacquer		700029762	1776
	Wood		700029760	2179
	Rustic-look wood		700029761	2413
90x52x48 / 35 <sup>3</sup> / <sub>8</sub> x20 <sup>1</sup> / <sub>2</sub> x18 <sup>7</sup> / <sub>8</sub>	Gloss lacquer	CENTERED	700029775	2095
	Matt lacquer		700029774	1863
	Wood		700029772	2271
	Rustic-look wood		700029773	2523
100x52x48 / 39 <sup>3</sup> / <sub>8</sub> x20 <sup>1</sup> / <sub>2</sub> x18 <sup>7</sup> / <sub>8</sub>	Gloss lacquer	CENTERED	700029787	2200
	Matt lacquer		700029786	1950
	Wood		700029784	2359
	Rustic-look wood		700029785	2628
120x52x48 / 47 <sup>1</sup> / <sub>4</sub> x20 <sup>1</sup> / <sub>2</sub> x18 <sup>7</sup> / <sub>8</sub>	Gloss lacquer	CENTERED / DX / SX	700029799	2398
	Matt lacquer		700029798	2112
	Wood		700029796	2528
	Rustic-look wood		700029797	2831

WASH BASIN UNIT BPS-1C D/S

DEPTH 48 CM / 18<sup>7</sup>/<sub>8</sub>"

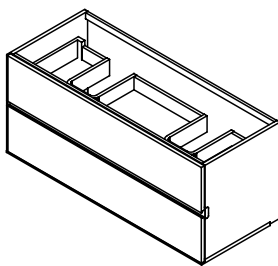

Basin unit with **NO** right side.

Base portalavabo **SENZA** spalla destra.

Тумбочка под умывальник БЕЗ правой боковой стороны.

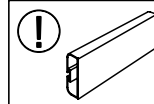

SPACER REQUIRED.  
AGGIUNGERE PROFILO DI SEPARAZIONE.  
НУЖДАЕТСЯ В ПРОФИЛЕ.

MEASURES (±x±x±)	FINISHES	BASIN	SAP	POINTS
120x52x48 / 47 <sup>1</sup> / <sub>4</sub> x20 <sup>1</sup> / <sub>2</sub> x18 <sup>7</sup> / <sub>8</sub>	Gloss lacquer	D/S	700029811	2430
	Matt lacquer		700029810	2144
	Wood		700029808	2559
	Rustic-look wood		700029809	2863



## WASH BASIN UNIT

DEPTH 48 CM / 18<sup>7</sup>/<sub>8</sub>"

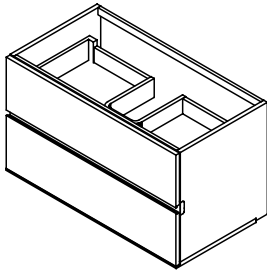

Basin unit with **NO** sides.

Base portalavabo **SENZA** fianchi.

Тумбочка под умывальник БЕЗ боковых сторон.

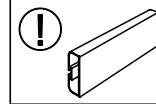

SPACER REQUIRED.

AGGIUNGERE PROFILO DI SEPARAZIONE.

НУЖДАЕТСЯ В ПРОФИЛЕ.

MEASURES (x x x)	FINISHES	BASIN	SAP	POINTS
60x52x48 / 23 <sup>5</sup> / <sub>8</sub> x20 <sup>1</sup> / <sub>2</sub> x18 <sup>7</sup> / <sub>8</sub>	Gloss lacquer	CENTERED	700030012	1677
	Matt lacquer		700030030	1487
	Wood		700030031	1943
	Rustic-look wood		700030002	2127
80x52x48 / 31 <sup>1</sup> / <sub>2</sub> x20 <sup>1</sup> / <sub>2</sub> x18 <sup>7</sup> / <sub>8</sub>	Gloss lacquer	CENTERED / SX	700030013	1865
	Matt lacquer		700030003	1637
	Wood		700030021	2123
	Rustic-look wood		700030024	2344
90x52x48 / 35 <sup>3</sup> / <sub>8</sub> x20 <sup>1</sup> / <sub>2</sub> x18 <sup>7</sup> / <sub>8</sub>	Gloss lacquer	CENTERED	700029984	1969
	Matt lacquer		700030023	1723
	Wood		700030022	2216
	Rustic-look wood		700029992	2454
100x52x48 / 39 <sup>3</sup> / <sub>8</sub> x20 <sup>1</sup> / <sub>2</sub> x18 <sup>7</sup> / <sub>8</sub>	Gloss lacquer	CENTERED	700030020	2074
	Matt lacquer		700029991	1810
	Wood		700029985	2303
	Rustic-look wood		700030014	2558
120x52x48 / 47 <sup>1</sup> / <sub>4</sub> x20 <sup>1</sup> / <sub>2</sub> x18 <sup>7</sup> / <sub>8</sub>	Gloss lacquer	CENTERED / DX / SX	700030016	2272
	Matt lacquer		700030011	1973
	Wood		700029982	2472
	Rustic-look wood		700029983	2762

## WASH BASIN UNIT BPS D/S

DEPTH 48 CM / 18<sup>7</sup>/<sub>8</sub>"

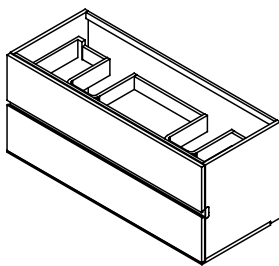

Basin unit with **NO** sides.

Base portalavabo **SENZA** fianchi.

Тумбочка под умывальник БЕЗ боковых сторон.

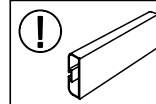

SPACER REQUIRED.

AGGIUNGERE PROFILO DI SEPARAZIONE.

НУЖДАЕТСЯ В ПРОФИЛЕ.

MEASURES (x x x)	FINISHES	BASIN	SAP	POINTS
120x52x48 / 47 <sup>1</sup> / <sub>4</sub> x20 <sup>1</sup> / <sub>2</sub> x18 <sup>7</sup> / <sub>8</sub>	Gloss lacquer	D/S	700029993	2304
	Matt lacquer		700030015	2005
	Wood		700029986	2504
	Rustic-look wood		700030004	2794

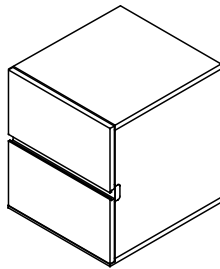

Wall-hung module with **NO** sides.

Modulo sospeso **SENZA** fianchi.

Настенный модуль БЕЗ боковых сторон.

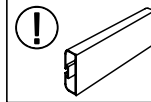

SPACER REQUIRED.  
AGGIUNGERE PROFILO DI SEPARAZIONE.  
НУЖДАЕТСЯ В ПРОФИЛЕ.

MEASURES (x x x)	FINISHES	SAP	POINTS
30x52x48 / 11 <sup>3</sup> / <sub>4</sub> x20 <sup>1</sup> / <sub>2</sub> x18 <sup>7</sup> / <sub>8</sub>	Gloss lacquer	700029815	1362
	Matt lacquer	700029814	1198
	Wood	700029812	1539
	Rustic-look wood	700029813	1604
40x52x48 / 15 <sup>3</sup> / <sub>4</sub> x20 <sup>1</sup> / <sub>2</sub> x18 <sup>7</sup> / <sub>8</sub>	Gloss lacquer	700029827	1483
	Matt lacquer	700029826	1292
	Wood	700029824	1630
	Rustic-look wood	700029825	1711
45x52x48 / 17 <sup>3</sup> / <sub>4</sub> x20 <sup>1</sup> / <sub>2</sub> x18 <sup>7</sup> / <sub>8</sub>	Gloss lacquer	700029839	1503
	Matt lacquer	700029838	1309
	Wood	700029836	1653
	Rustic-look wood	700029837	1762
50x52x48 / 19 <sup>5</sup> / <sub>8</sub> x20 <sup>1</sup> / <sub>2</sub> x18 <sup>7</sup> / <sub>8</sub>	Gloss lacquer	700029851	1528
	Matt lacquer	700029850	1338
	Wood	700029848	1694
	Rustic-look wood	700029849	1812
60x52x48 / 23 <sup>5</sup> / <sub>8</sub> x20 <sup>1</sup> / <sub>2</sub> x18 <sup>7</sup> / <sub>8</sub>	Gloss lacquer	700029863	1596
	Matt lacquer	700029862	1405
	Wood	700029860	1773
	Rustic-look wood	700029861	1908

## FREESTANDING UNIT DX

DEPTH 48 CM / 18<sup>7/8</sup>"

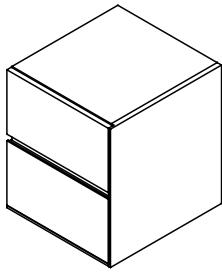

Wall-hung module with **NO** left side.

Modulo sospeso **SENZA** spalla sinistra.

Настенный модуль БЕЗ левой боковой стороны.

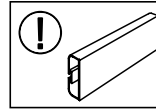

SPACER REQUIRED.

AGGIUNGERE PROFILO DI SEPARAZIONE.

НУЖДАЕТСЯ В ПРОФИЛЕ.

MEASURES	FINISHES	SAP	POINTS
30x52x48 / 11 <sup>3/4</sup> x20 <sup>1/2</sup> x18 <sup>7/8</sup>	Gloss lacquer	700029819	1482
	Matt lacquer	700029818	1334
	Wood	700029816	1679
	Rustic-look wood	700029817	1807
40x52x48 / 15 <sup>3/4</sup> x20 <sup>1/2</sup> x18 <sup>7/8</sup>	Gloss lacquer	700029831	1603
	Matt lacquer	700029830	1427
	Wood	700029828	1771
	Rustic-look wood	700029829	1914
45x52x48 / 17 <sup>3/4</sup> x20 <sup>1/2</sup> x18 <sup>7/8</sup>	Gloss lacquer	700029843	1626
	Matt lacquer	700029842	1448
	Wood	700029840	1795
	Rustic-look wood	700029841	1966
50x52x48 / 19 <sup>5/8</sup> x20 <sup>1/2</sup> x18 <sup>7/8</sup>	Gloss lacquer	700029855	1652
	Matt lacquer	700029854	1476
	Wood	700029852	1836
	Rustic-look wood	700029853	2016
60x52x48 / 23 <sup>5/8</sup> x20 <sup>1/2</sup> x18 <sup>7/8</sup>	Gloss lacquer	700029867	1719
	Matt lacquer	700029866	1542
	Wood	700029864	1914
	Rustic-look wood	700029865	2112

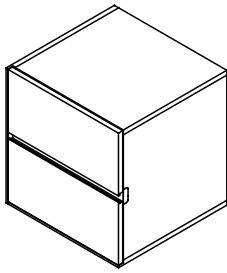

Wall-hung module with **NO** right side.  
 Modulo sospeso **SENZA** spalla destra.  
 Настенный модуль БЕЗ правой боковой стороны.

SPACER REQUIRED.  
 AGGIUNGERE PROFILO DI SEPARAZIONE.  
 НУЖДАЕТСЯ В ПРОФИЛЕ.

MEASURES (x x x)	FINISHES	SAP	POINTS
30x52x48 / 11 <sup>3/4</sup> x20 <sup>1/2</sup> x18 <sup>7/8</sup>	Gloss lacquer	700029823	1482
	Matt lacquer	700029822	1334
	Wood	700029820	1679
	Rustic-look wood	700029821	1807
40x52x48 / 15 <sup>3/4</sup> x20 <sup>1/2</sup> x18 <sup>7/8</sup>	Gloss lacquer	700029835	1603
	Matt lacquer	700029834	1427
	Wood	700029832	1771
	Rustic-look wood	700029833	1914
45x52x48 / 17 <sup>3/4</sup> x20 <sup>1/2</sup> x18 <sup>7/8</sup>	Gloss lacquer	700029847	1626
	Matt lacquer	700029846	1448
	Wood	700029844	1795
	Rustic-look wood	700029845	1966
50x52x48 / 19 <sup>5/8</sup> x20 <sup>1/2</sup> x18 <sup>7/8</sup>	Gloss lacquer	700029859	1652
	Matt lacquer	700029858	1476
	Wood	700029856	1836
	Rustic-look wood	700029857	2016
60x52x48 / 23 <sup>5/8</sup> x20 <sup>1/2</sup> x18 <sup>7/8</sup>	Gloss lacquer	700029871	1719
	Matt lacquer	700029870	1542
	Wood	700029868	1914
	Rustic-look wood	700029869	2112

PERFIL SEPARADOR BPS/MS

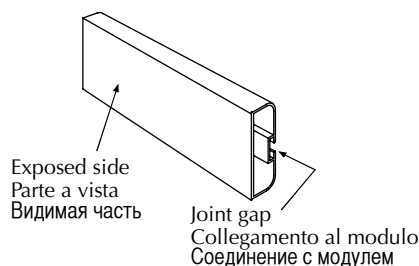

**Price per linear metre (39<sup>3/8</sup>).**  
 Maximum measure. 4.500 mm. (177<sup>7/8</sup>).  
 Include joint element for horizontal spacer.

**Prezzo per metro lineare (39<sup>3/8</sup>).**  
 Misura massima, 4.500 mm. (177<sup>7/8</sup>).  
 Completa di profilo separazione orizzontale.

**Цена за линейный метр (39<sup>3/8</sup>).**  
 Максимальный размер, 4.500 мм. (177<sup>7/8</sup>).  
 Включает крепежные для горизонтального профиля.

FINISHES	SAP	POINTS x 1 m/l. (39 <sup>3/8</sup> )
Gloss lacquer		180
Matt lacquer		160
Wood	700029890	180
Rustic-look wood		200
Sable		130

## MSC DX

DEPTH 30 CM / 11<sup>3/4</sup>"

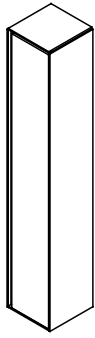

Tower unit with door. DX.

Modulo colonna con anta. DX / SX.

Вертикальный блок с дверцей. DX / SX.

MEASURES	(  )	FINISHES	PROFILE OPTIONS	SAP	POINTS
30x156x30 / 11 <sup>3/4</sup> x61 <sup>3/8</sup> x11 <sup>3/4</sup>		Gloss lacquer	Gloss lacquer / Matt lacquer / Wood / Rustic-look wood / Sable.	700029875	2344
		Matt lacquer		700029874	2077
		Wood		700029872	2709
		Rustic-look wood		700029873	3230
30x168x30 / 11 <sup>3/4</sup> x66 <sup>1/8</sup> x11 <sup>3/4</sup>		Gloss lacquer	Gloss lacquer / Matt lacquer / Wood / Rustic-look wood / Sable.	700029883	2451
		Matt lacquer		700029882	2167
		Wood		700029880	2822
		Rustic-look wood		700029881	3376

## MSC SX

DEPTH 30 CM / 11<sup>3/4</sup>"

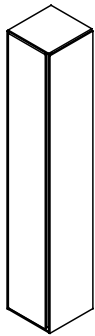

Tower unit with door. SX.

Modulo colonna con anta. DX / SX.

Вертикальный блок с дверцей. DX / SX.

MEASURES	(  )	FINISHES	PROFILE OPTIONS	SAP	POINTS
30x156x30 / 11 <sup>3/4</sup> x61 <sup>3/8</sup> x11 <sup>3/4</sup>		Gloss lacquer	Gloss lacquer / Matt lacquer / Wood / Rustic-look wood / Sable.	700029879	2344
		Matt lacquer		700029878	2077
		Wood		700029876	2709
		Rustic-look wood		700029877	3230
30x168x30 / 11 <sup>3/4</sup> x66 <sup>1/8</sup> x11 <sup>3/4</sup>		Gloss lacquer	Gloss lacquer / Matt lacquer / Wood / Rustic-look wood / Sable.	700029887	2451
		Matt lacquer		700029886	2167
		Wood		700029884	2822
		Rustic-look wood		700029885	3376

## SLIM BASIN

DEPTH 49CM / 19 1/4"

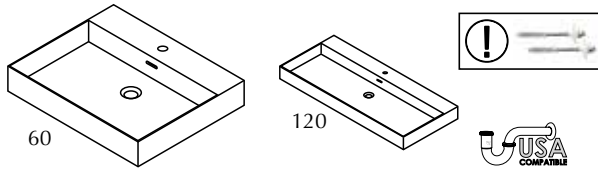

- GELCOAT basin with overflow.
- Requires for installation valve SAP100200010, 72 P.
- Lavabo GELCOAT con troppopieno.
- Richiede valvola SAP100200010, 72 P.
- Раковина GELCOAT с переливом.
- Требуется установка клапана SAP100200010, 72 P.

MEASURES	FINISHES	SAP	POINTS
60x10x49 / 23 5/8 x 3 7/8 x 19 1/4	GELCOAT	100221199	596
80x10x49 / 31 1/2 x 3 7/8 x 19 1/4		100221201	682
90x10x49 / 35 3/8 x 3 7/8 x 19 1/4		100221203	765
100x10x49 / 39 3/8 x 3 7/8 x 19 1/4		100241700	784
120x10x49 / 47 1/4 x 3 7/8 x 19 1/4		100221205	822
① FIXINGS / ANCLAJE PARED. 60/80/90/100 (1UND.) - 120 (2UNDS.)		250010391	9

## SLIM BASIN

### COUNTERTOP / SOBRE ENCIMERA / VASQUE SUR PLAN

REQUIRES WORKTOP

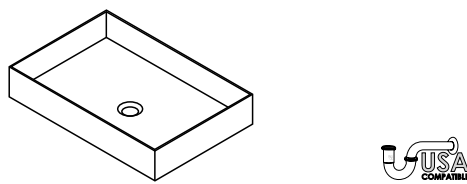

- GELCOAT basin. **REQUIRES WORKTOP.**
- Requires for installation valve SAP100036254, 68 P.
- Lavabo GELCOAT. **RICIEDE TOP IN.**
- Richiede valvola SAP100036254, 68 P.
- Раковина GELCOAT. **НУЖДАЕТСЯ В СТОЛЕШНИЦЕ.**
- Требуется установка клапана SAP100036254, 68 P.

MEASURES	FINISHES	SAP	POINTS
50x10x33 / 19 5/8 x 3 7/8 x 13	GELCOAT	100221198	475

## SOTTO NOVA

### RECESSED SINK

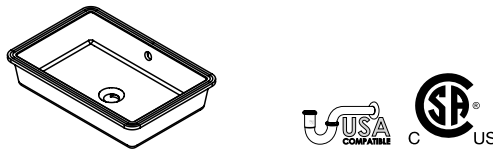

- Ceramic basin. **REQUIRES WORKTOP.**
- Lavabo in ceramica. **RICIEDE TOP.**
- Керамическая раковина. **НУЖДАЕТСЯ В СТОЛЕШНИЦЕ.**

MEASURES	FINISHES	SAP	POINTS
50x14,2x34 / 19 5/8 x 5 5/8 x 13 3/8	White ceramic	100241696	253
62x14,2x34 / 24 3/8 x 5 5/8 x 13 3/8		100286592	370

## FIT BASIN

DEPTH 49CM / 19 1/4"

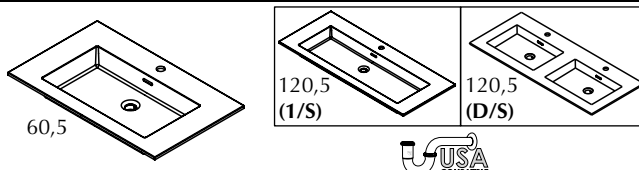

- GELCOAT basin with overflow.
- Requires for installation valve SAP100200010, 72 P.
- Lavabo GELCOAT con troppopieno.
- Richiede valvola SAP100200010, 72 P.
- Раковина GELCOAT с переливом.
- Требуется установка клапана SAP100200010, 72 P.

MEASURES	FINISHES	SAP	POINTS
60,5x13,5x49 / 23 7/8 x 5 3/8 x 19 1/4	GELCOAT	100241712	427
80,5x13,5x49 / 31 3/4 x 5 3/8 x 19 1/4		100241723	532
90,5x13,5x49 / 35 5/8 x 5 3/8 x 19 1/4		100241702	596
100,5x13,5x49 / 39 5/8 x 5 3/8 x 19 1/4		100241627	659
120,5x13,5x49 / 47 1/2 x 5 3/8 x 19 1/4 (1/S)		100241693	794
120,5x13,5x49 / 47 1/2 x 5 3/8 x 19 1/4 (D/S)		100296392	898

## ONES BASIN SEMI-RECESSED

DEPTH 48CM / 18 7/8"

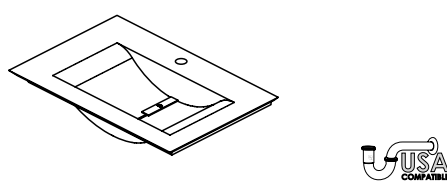

- GELCOAT basin. **REQUIRES WORKTOP.**
- Lavabo GELCOAT. **RICIEDE TOP IN.**
- Раковина GELCOAT. **НУЖДАЕТСЯ В СТОЛЕШНИЦЕ.**

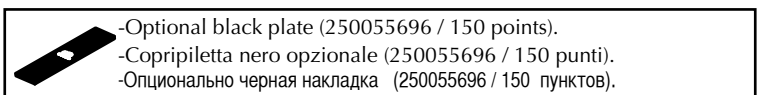

MEASURES	FINISHES	SAP	POINTS
60x13x48 / 23 5/8 x 5 1/8 x 18 7/8	GELCOAT	100110452	0942
71,5x13x48 / 28 1/8 x 5 1/8 x 18 7/8		100100508	0982
115x13x48 / 45 1/4 x 5 1/8 x 18 7/8		100100507	1202

## CICLO BASIN SEMI-RECESSED

DEPTH 48CM / 18<sup>7/8</sup>"

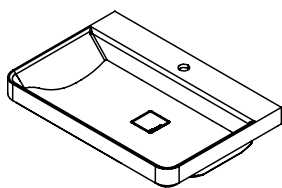

- GELCOAT basin. **REQUIRES WORKTOP.**
- It requires permanent overflow (100104178 / 59 Points).
- Lavabo GELCOAT. **RICHIÈDE TOP IN.**
- Richiede valvola (100104178 / 59 punti).
- Раковина GELCOAT. **НУЖДАЕТСЯ В СТОЛЕШНИЦЕ.**
- Требуется постоянный перелив (100104178 / 59 позиций).



- Optional black plate (250055710 / 143 points).
- Copripiletta nero opzionale (250055710 / 143 punti).
- Опционально черная накладка (250055710 / 143 пунктов).

MEASURES	FINISHES	SAP	POINTS
50x15x48 / 19 <sup>5/8</sup> x5 <sup>7/8</sup> x18 <sup>7/8</sup>	GELCOAT	100136309	632
70x15x48 / 27 <sup>1/2</sup> x5 <sup>7/8</sup> x18 <sup>7/8</sup>		100128501	736

## BASIN

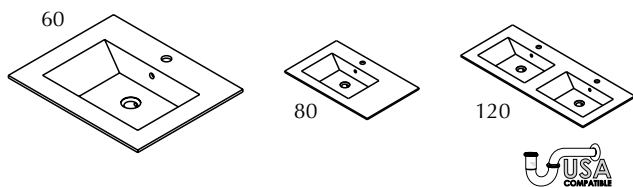

- GELCOAT basin with overflow.
- Requires for installation valve **SAP100200010, 72 P.**
- Lavabo GELCOAT con troppopieno.
- Richiede valvola **SAP100200010, 72 P.**
- Раковина GELCOAT с переливом.
- Требуется установка клапана SAP100200010, 72 P.

MEASURES	FINISHES	SAP	POINTS
60,5x14,1x49,2 / 23 <sup>7/8</sup> x5 <sup>1/2</sup> x19 <sup>3/8</sup>	GELCOAT	100160956	0560
80,5x14,1x49,2 / 31 <sup>3/4</sup> x5 <sup>1/2</sup> x19 <sup>3/8</sup>		100160957	0582
120,5x14,1x49,2 / 47 <sup>1/2</sup> x5 <sup>1/2</sup> x19 <sup>3/8</sup>		100171860	0981

## KRION STONE WORKTOP WITH INTEGRATED BASIN

DEPTH 49,2CM / 19<sup>3/8</sup>"

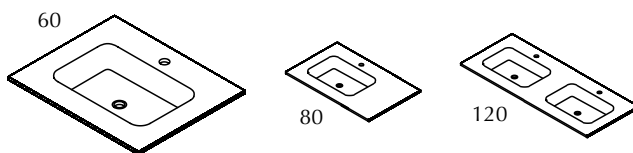

- Worktop KRION STONE with integrated basin.
- Requires for installation permanent valve SAP100036254, 68 P.
- Requires drainage SAP100036255, 103 P.
- Top in KRION STONE con lavabo integrato.
- Richiede valvola SAP100036254, 68 P.
- Richiede scarico SAP100036255, 103 P.
- Столешница KRION STONE со встроенной раковиной.
- Требуется установка постоянного клапана SAP100036254, 68 P.
- Требуется дренаж SAP100036255, 103 P.

MEASURES	FINISHES	SAP	POINTS
60,2x13x49,2 / 23 <sup>5/8</sup> x5 <sup>1/8</sup> x19 <sup>3/8</sup>	Krión STONE	100091017	617
80,2x13x49,2 / 31 <sup>1/2</sup> x5 <sup>1/8</sup> x19 <sup>3/8</sup>		100091018	660
120,2x13x49,2 / 47 <sup>3/8</sup> x5 <sup>1/8</sup> x19 <sup>3/8</sup>		100110448	1356

## CUSTOM MIRROR

ESP-RANGO	↑							
	15-30 cm. 5 <sup>7/8</sup> -11 <sup>3/4</sup>	30,1-60 cm. 11 <sup>7/8</sup> -23 <sup>5/8</sup>	60,1-90 cm. 23 <sup>5/8</sup> -35 <sup>3/8</sup>	90,1-120 cm. 35 <sup>1/2</sup> -47 <sup>1/4</sup>	120,1-150 cm. 47 <sup>1/4</sup> -59	150,1-180 cm. 59 <sup>1/8</sup> -70 <sup>7/8</sup>	180,1-210 cm. 70 <sup>7/8</sup> -82 <sup>5/8</sup>	
↑	15-30 cm. 5 <sup>7/8</sup> -11 <sup>3/4</sup>	SAP 700026272 164 P.	SAP 700026312 177 P.	SAP 700026275 189 P.	SAP 700026276 222 P.	SAP 700026293 251 P.	SAP 700026320 283 P.	SAP 700026315 310 P.
	30,1-60 cm. 11 <sup>7/8</sup> -23 <sup>5/8</sup>	SAP 700026304 182 P.	SAP 700026305 208 P.	SAP 700026303 241 P.	SAP 700026285 293 P.	SAP 700026294 340 P.	SAP 700026306 378 P.	SAP 700026277 422 P.
	60,1-90 cm. 23 <sup>5/8</sup> -35 <sup>3/8</sup>	SAP 700026307 195 P.	SAP 700026278 241 P.	SAP 700026279 285 P.	SAP 700026273 347 P.	SAP 700026237 414 P.	SAP 700026238 484 P.	SAP 700026282 539 P.
	90,1-120 cm. 35 <sup>1/2</sup> -47 <sup>1/4</sup>	SAP 700026313 218 P.	SAP 700026283 282 P.	SAP 700026314 337 P.	SAP 700026284 418 P.	SAP 700026302 514 P.	SAP 700026274 675 P.	SAP 700026239 754 P.



The interpretation made in inches for the dimensions of the different items shown in the price list has been rounded to 1/8, however for a more accurate measurement please use millimetres or centimetres.

## Blind

<b>EXTERIOR FINISHES</b> FINITURE ESTERNE ОТДЕЛКА ДЛЯ НАРУЖНОГО ИСПОЛЬЗОВАНИЯ	<input type="checkbox"/> Laminate Laminato ЛАМИНАТ	<input type="checkbox"/> Matt lacquer Laccato opaco МАТОВЫЙ ЛАК	<input checked="" type="checkbox"/> Wood veneer Legno ДЕРЕВО
	<input type="checkbox"/> HPL Stratificato СЛОИСТАЯ	<input type="checkbox"/> Gloss lacquer Laccato lucido ГЛЯНЦЕВЫЙ ЛАК	<input type="checkbox"/> Aluminium, Metal finish Alluminio, finitura Metal Алюминий, отделка Metal
<b>INTERIOR FINISHES</b> FINITURE INTERNE ОТДЕЛКА ДЛЯ ВНУТРЕННЕГО ИСПОЛЬЗОВАНИЯ	<input type="checkbox"/> Laminate Laminato ЛАМИНАТ	<input checked="" type="checkbox"/> Wood veneer Legno ДЕРЕВО	<input type="checkbox"/> Aluminium+laminated base Alluminio + base in laminato Алюминий + основа из ламината
	<input checked="" type="checkbox"/> Front handle Maniglia frontale a vista Декоративная передняя ручка	<input type="checkbox"/> Integrated metal handle Maniglia metallica integrata Встроенная металлическая ручка	<input type="checkbox"/> Integrated mechanized h. Maniglia integrata ricavata sul bordo Встроенная ручка по краю
<b>HANDLES</b> MANIGLIE РУЧКИ	<input type="checkbox"/> Push handle Maniglia Push РУЧКИ Push		
<b>TYPE OF UNITS</b> TIPI DI MODULI ТИПЫ МОДУЛЕЙ	<input checked="" type="checkbox"/> Compact Compatto Компактная	<input type="checkbox"/> Modular Modulare Модульная	
<b>POSITION</b> POSIZIONE ПОЗИЦИЯ	<input checked="" type="checkbox"/> Wall-mounted Sospeso Подвесная	<input checked="" type="checkbox"/> Floor-mounted A terra Напольная	
<b>MEASURES (CM)</b> DIMENSIONI РАЗМЕРЫ	90 / 120	60	48
	35 <sup>3/8</sup> / 47 <sup>1/4</sup>	23 <sup>5/8</sup>	18 <sup>7/8</sup>
<b>WORKTOP &amp; BASIN OPTIONS</b> OPZIONI TOP E LAVABI ВАРИАНТЫ СТОЛЕШНИЦ И УМЫВАЛЬНЫХ РАКОВИН	<input checked="" type="checkbox"/> Bath serie's worktop / basin Lavabo / top della serie Серийная умывальная раковина / столешница	<input type="checkbox"/> Standard worktops Top standard Стандартные столешницы	<input type="checkbox"/> Worktop + integrated basin Encimera + lavabo integrato Столешница + встроенная умывальная раковина
	<input checked="" type="checkbox"/> Over-mounted basin Lavabo da appoggio Настольная умывальная раковина	<input type="checkbox"/> Under-mounted basin Lavabo sottopiano Умывальная раковина, встраиваемая в столешницу снизу	<input checked="" type="checkbox"/> Double basin as option Opzione doppia vasca Вариант с двойной чашей
<b>WORKTOP FINISHES</b> FINITURE TOP ОТДЕЛКА СТОЛЕШНИЦ	<input type="checkbox"/> Krion® worktop Top in KRION® Столешница KRION®	<input type="checkbox"/> Gel Coat worktop Top in Gel Coat Столешница с покрытием гелькоут	<input checked="" type="checkbox"/> Natural Stone worktop Top in pietra naturale Столешница из натурального камня.
	<input type="checkbox"/> Glass worktop Top in vetro Столешница из стекла	<input type="checkbox"/> Bath furniture finish worktop Top con la finitura del mobile Столешница с той же отделкой, что и консоль/тумба	
<b>BASIN FINISHES</b> FINITURE LAVABI ОТДЕЛКА УМЫВАЛЬНЫХ РАКОВИН	<input type="checkbox"/> Krion® basin Lavabo in Krion® Умывальная раковина из Krion®	<input checked="" type="checkbox"/> Gel Coat basin Lavabo Gelcoat Раковина Gelcoat	<input checked="" type="checkbox"/> Ceramic basin Lavabo in ceramica Керамическая умывальная раковина
	<input checked="" type="checkbox"/> Natural Stone basin Lavabo in pietra naturale Умывальная раковина из натурального камня.		
<b>ACCESSORIES</b> ACCESSORI АКСЕССУАРЫ	<input checked="" type="checkbox"/> Mirror Specchio Зеркало	<input type="checkbox"/> Wall-mounted module Modulo sospeso Подвесной модуль	<input type="checkbox"/> Tall cabinet Modulo colonna Высокий шкаф
	<input type="checkbox"/> Upper unit Modulo alto Верхний модуль	<input type="checkbox"/> Organizer Organizzatore Органайзер	<input type="checkbox"/> Shelves Mensola Полка
			<input type="checkbox"/> Accessories Accessori Аксессуары



# *blind*



Blind is a bathroom furniture that bets on tradition and simplicity, obtaining a unique bathroom vanity; it includes a sliding system door, reminiscent of furniture from the 30s and 40s but with a totally reinvented aesthetic, thanks to the minimalism in all its design.

Blind è un mobile bagno che punta sulla tradizione e sulla semplicità; caratterizzato da una apertura con persiana scorrevole, che rievoca gli arredi degli anni 30-40, ma con un'estetica totalmente rivisitata mantenendo il design minimale.

Blind - это мебель для ванной комнаты, которая делает ставку на традиционность и простоту. Приобретая уникальный шкаф для ванной комнаты, в качестве двери была установлена раздвижная система жалюзи, напоминающая мебель 30-х - 40-х годов, но с эстетическим подходом, полностью обновленным благодаря минимализму во всем ее дизайне.



9007 Points  
**BLIND Roble Noche**

+info p.381



+info p.381

**15692 Points**  
**BLIND Roble Cobre**

## FINISHES

WOOD

LEGNO

ДЕРЕВО



Roble noche



Roble cobre



Roble bronce



Roble sil



Roble alba

WORKTOPS

TOP

СТОЛЕШНИЦЫ



Mármol  
Carrara



Barocco  
Vintage



Cheyenne  
Vintage



Amarula  
Vintage

## WASH BASIN UNIT BPS

DEPTH 49,5CM / 19<sup>1/2</sup>"

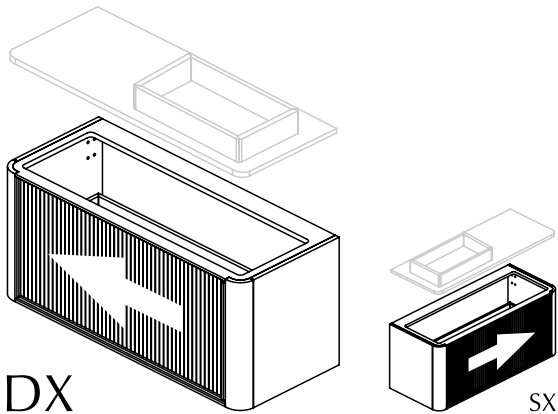

Wash basin unit.

Basi portlavabo

Тумбочка под умывальник.

DX

SX



MEASURES	(xx)	FINISHES	SAP	POINTS
90x52x49,5 / 35 <sup>3/8</sup> x20 <sup>1/2</sup> x19 <sup>1/2</sup>		Wood DX/SX	700026292	3387
120x52x49,5 / 47 <sup>1/4</sup> x20 <sup>1/2</sup> x19 <sup>1/2</sup>			700026300	3584
90x52x49,5 / 35 <sup>3/8</sup> x20 <sup>1/2</sup> x19 <sup>1/2</sup>		Wood DX/SX	<b>ONLY USA</b> 700026681	3439
120x52x49,5 / 47 <sup>1/4</sup> x20 <sup>1/2</sup> x19 <sup>1/2</sup>			<b>SOTTO BASIN</b> 700026680	3636

## LEG

-Legs are optional. For Sotto basin.

-Piedini opzionali. Per lavabo sottotop.

-Нога опциональная. Для раковины Sotto

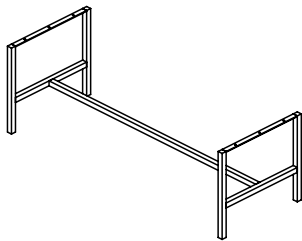

MEASURES	(xx)	FINISHES	SAP	POINTS
77x35x39,5 / 30 <sup>3/8</sup> x13 <sup>3/4</sup> x15 <sup>1/2</sup>		(BPS-90) Metal	100243169	0412
107,1x35x39,5 / 42 <sup>1/8</sup> x13 <sup>3/4</sup> x15 <sup>1/2</sup>		(BPS-120) Metal	100243168	0429

## LEG

-Legs are optional. For over mounted basin.

-Piedini opzionali. Per lavabo in appoggio.

-Нога опциональная. Для накладной раковины

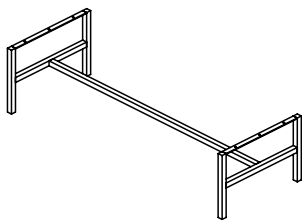

MEASURES	(xx)	FINISHES	SAP	POINTS
77x26x39,5 / 30 <sup>3/8</sup> x10 <sup>1/4</sup> x15 <sup>1/2</sup>		(BPS-90) Metal	100243191	0412
107,1x26x39,5 / 42 <sup>1/8</sup> x10 <sup>1/4</sup> x15 <sup>1/2</sup>		(BPS-120) Metal	100243178	0429

# blind

## BLIND BASIN DX

DEPTH 49,5CM / 19<sup>1/2</sup>"

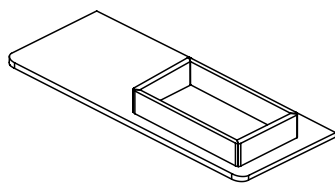

- Basin.
- Requires valve SAP100104178, 59 P.
- Lavabo.
- Richiede valvola SAP100104178, 59 P.
- Раковина.
- Требуется постоянный перелив SAP100104178, 59 P.

MEASURES	FINISHES	SAP	POINTS
90x11x49,5 / 35 <sup>3/8</sup> x4 <sup>3/8</sup> x19 <sup>1/2</sup>	Mármol Carrara	700026245	2320
	Barocco Vintage	700026261	2667
	Cheyenne Vintage	700026251	2667
	Amarula Vintage	700026242	2854
120x11x49,5 / 47 <sup>1/4</sup> x4 <sup>3/8</sup> x19 <sup>1/2</sup>	Mármol Carrara	700026311	2425
	Barocco Vintage	700026246	2843
	Cheyenne Vintage	700026265	2843
	Amarula Vintage	700026230	3073

## BLIND BASIN SX

DEPTH 49,5CM / 19<sup>1/2</sup>"

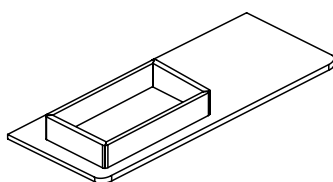

- Basin.
- Requires valve SAP100104178, 59 P.
- Lavabo.
- Richiede valvola SAP100104178, 59 P.
- Раковина.
- Требуется постоянный перелив SAP100104178, 59 P.

MEASURES	FINISHES	SAP	POINTS
90x11x49,5 / 35 <sup>3/8</sup> x4 <sup>3/8</sup> x19 <sup>1/2</sup>	Mármol Carrara	700026263	2320
	Barocco Vintage	700026247	2667
	Cheyenne Vintage	700026254	2667
	Amarula Vintage	700026216	2854
120x11x49,5 / 47 <sup>1/4</sup> x4 <sup>3/8</sup> x19 <sup>1/2</sup>	Mármol Carrara	700026224	2425
	Barocco Vintage	700026211	2843
	Cheyenne Vintage	700026212	2843
	Amarula Vintage	700026240	3073

## SOTTO NOVA

## RECESSED SINK

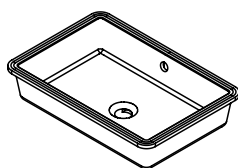

- Ceramic basin. **REQUIRES WORKTOP.**
- Lavabo in ceramica. **RICHIESTE TOP.**
- Керамическая раковина. **НУЖДАЕТСЯ В СТОЛЕШНИЦЕ.**

MEASURES	FINISHES	SAP	POINTS
50x14,2x34 / 19 <sup>5/8</sup> x5 <sup>5/8</sup> x13 <sup>3/8</sup>	White ceramic	100241696	253
62x14,2x34 / 24 <sup>3/8</sup> x5 <sup>5/8</sup> x13 <sup>3/8</sup>		100286592	370

## SLIM BASIN

## COUNTERTOP / SOBRE ENCIMERA / VASQUE SUR PLAN

## REQUIRES WORKTOP

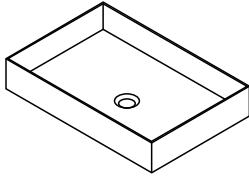

- GELCOAT basin. **REQUIRES WORKTOP.**
- Requires for installation valve SAP100036254, 68 P.
- Lavabo GELCOAT. **RICHIEDE TOP IN.**
- Richiede valvola SAP100036254, 68 P.
- Раковина GELCOAT. **НУЖДАЕТСЯ В СТОЛЕШНИЦЕ.**
- Требуется установка клапана SAP100036254, 68 P.

MEASURES	FINISHES	SAP	POINTS
50x10x33 / 19 <sup>5/8</sup> x3 <sup>7/8</sup> x13	GELCOAT	100221198	475

## MIRROR

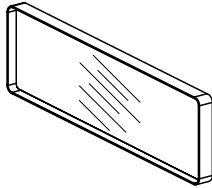

- Mirror w/o light.
- Specchio senza illuminazione.
- Зеркало без подсветки.

MEASURES	FINISHES	SAP	POINTS
60x30x6 / 23 <sup>5/8</sup> x11 <sup>3/4</sup> x2 <sup>3/8</sup>	Metal	700026258	719
90x30x6 / 35 <sup>3/8</sup> x11 <sup>3/4</sup> x2 <sup>3/8</sup>		700026259	777
120x30x6 / 47 <sup>1/4</sup> x11 <sup>3/4</sup> x2 <sup>3/8</sup>		700026225	886
150x30x6 / 59x11 <sup>3/4</sup> x2 <sup>3/8</sup>		700026256	931
60x45x6 / 23 <sup>5/8</sup> x17 <sup>3/4</sup> x2 <sup>3/8</sup>		700026280	773
90x45x6 / 35 <sup>3/8</sup> x17 <sup>3/4</sup> x2 <sup>3/8</sup>		700026269	838
120x45x6 / 47 <sup>1/4</sup> x17 <sup>3/4</sup> x2 <sup>3/8</sup>		700026234	959
150x45x6 / 59x17 <sup>3/4</sup> x2 <sup>3/8</sup>		700026257	1021
60x60x6 / 23 <sup>5/8</sup> x23 <sup>5/8</sup> x2 <sup>3/8</sup>		700026290	843
90x60x6 / 35 <sup>3/8</sup> x23 <sup>5/8</sup> x2 <sup>3/8</sup>		700026291	898
120x60x6 / 47 <sup>1/4</sup> x23 <sup>5/8</sup> x2 <sup>3/8</sup>		700026235	1027
150x60x6 / 59x23 <sup>5/8</sup> x2 <sup>3/8</sup>		700026264	1095

## MIRROR

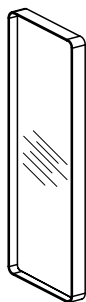

- Mirror w/o light.
- Specchio senza illuminazione.
- Зеркало без подсветки.

MEASURES	FINISHES	SAP	POINTS
30x60x6 / 11 <sup>3/4</sup> x23 <sup>5/8</sup> x2 <sup>3/8</sup>	Metal	700026249	719
45x60x6 / 17 <sup>3/4</sup> x23 <sup>5/8</sup> x2 <sup>3/8</sup>		700026219	773
30x90x6 / 11 <sup>3/4</sup> x35 <sup>3/8</sup> x2 <sup>3/8</sup>		700026266	777
45x90x6 / 17 <sup>3/4</sup> x35 <sup>3/8</sup> x2 <sup>3/8</sup>		700026267	838
60x90x6 / 23 <sup>5/8</sup> x35 <sup>3/8</sup> x2 <sup>3/8</sup>		700026236	898
30x120x6 / 11 <sup>3/4</sup> x47 <sup>1/4</sup> x2 <sup>3/8</sup>		700026226	886
45x120x6 / 17 <sup>3/4</sup> x47 <sup>1/4</sup> x2 <sup>3/8</sup>		700026270	959
60x120x6 / 23 <sup>5/8</sup> x47 <sup>1/4</sup> x2 <sup>3/8</sup>		700026268	1027
30x150x6 / 11 <sup>3/4</sup> x59x2 <sup>3/8</sup>		700026227	931
45x150x6 / 17 <sup>3/4</sup> x59x2 <sup>3/8</sup>		700026228	1021
60x150x6 / 23 <sup>5/8</sup> x59x2 <sup>3/8</sup>		700026229	1095



The interpretation made in inches for the dimensions of the different items shown in the price list has been rounded to 1/8, however for a more accurate measurement please use millimetres or centimetres.

## Side

<b>EXTERIOR FINISHES</b> FINITURE ESTERNE ОТДЕЛКА ДЛЯ НАРУЖНОГО ИСПОЛЬЗОВАНИЯ	<input checked="" type="checkbox"/> Laminate Laminato ЛАМИНАТ	<input checked="" type="checkbox"/> Matt lacquer Laccato opaco МАТОВЫЙ ЛАК	<input checked="" type="checkbox"/> Wood veneer Legno ДЕРЕВО
	<input type="checkbox"/> HPL Stratificato СЛОИСТАЯ	<input checked="" type="checkbox"/> Gloss lacquer Laccato lucido ГЛЯНЦЕВЫЙ ЛАК	<input type="checkbox"/> Aluminium, Metal finish Alluminio, finitura Metal Алюминий, отделка Metal
<b>INTERIOR FINISHES</b> FINITURE INTERNE ОТДЕЛКА ДЛЯ ВНУТРЕННЕГО ИСПОЛЬЗОВАНИЯ	<input type="checkbox"/> Laminate Laminato ЛАМИНАТ	<input type="checkbox"/> Wood veneer Legno ДЕРЕВО	<input checked="" type="checkbox"/> Aluminium+laminato base Alluminio + base in laminato Алюминий + основа из ламината
	<input type="checkbox"/> Front handle Maniglia frontale a vista Декоративная передняя ручка	<input type="checkbox"/> Integrated metal handle Maniglia metallica integrata Встроенная металлическая ручка	<input checked="" type="checkbox"/> Integrated mechanized h. Maniglia integrata ricavata sul bordo Встроенная ручка по краю
<b>HANDLES</b> MANIGLIE РУЧКИ	<input type="checkbox"/> Push handle Maniglia Push РУЧКИ Push		
<b>TYPE OF UNITS</b> TIPI DI MODULI ТИПЫ МОДУЛЕЙ	<input checked="" type="checkbox"/> Compact Compatto Компактная	<input checked="" type="checkbox"/> Modular Modulare Модульная	
<b>POSITION</b> POSIZIONE ПОЗИЦИЯ	<input checked="" type="checkbox"/> Wall-mounted Sospeso Подвесная	<input checked="" type="checkbox"/> Floor-mounted A terra Напольная	
<b>MEASURES (CM)</b> DIMENSIONI РАЗМЕРЫ	◀ 60 / 80 / 90 / 100 / 120 23 <sup>5/8</sup> / 31 <sup>1/2</sup> / 35 <sup>3/8</sup> / 39 <sup>3/8</sup> / 47 <sup>1/4</sup>	▲ 26 / 52 / 78 10 <sup>1/4</sup> / 20 <sup>1/2</sup> / 30 <sup>3/4</sup>	▶ 48 18 <sup>7/8</sup>
<b>WORKTOP &amp; BASIN OPTIONS</b> OPZIONI TOP E LAVABI ВАРИАНТЫ СТОЛЕШНИЦ И УМЫВАЛЬНЫХ РАКОВИН	<input type="checkbox"/> Bath serie's worktop / basin Lavabo / top della serie Серийная умывальная раковина / столешница	<input checked="" type="checkbox"/> Standard worktops Top standard Стандартные столешницы	<input checked="" type="checkbox"/> Worktop + integrated basin Encimera + lavabo integrato Столешница + встроенная умывальная раковина
	<input checked="" type="checkbox"/> Over-mounted basin Lavabo da appoggio Настольная умывальная раковина	<input checked="" type="checkbox"/> Under-mounted basin Lavabo sottopiano Умывальная раковина, встраиваемая в столешницу снизу	<input checked="" type="checkbox"/> Double basin as option Opzione doppia vasca Вариант с двойной чашей
<b>WORKTOP FINISHES</b> FINITURE TOP ОТДЕЛКА СТОЛЕШНИЦ	<input checked="" type="checkbox"/> Krion® worktop Top in KRION® Столешница KRION®	<input type="checkbox"/> Gel Coat worktop Top in Gel Coat Столешница с покрытием гелькоут	<input checked="" type="checkbox"/> Natural Stone worktop Top in pietra naturale Столешница из натурального камня.
	<input type="checkbox"/> Glass worktop Top in vetro Столешница из стекла	<input type="checkbox"/> Bath furniture finish worktop Top con la finitura del mobile Столешница с той же отделкой, что и консоль/тумба	
<b>BASIN FINISHES</b> FINITURE LAVABI ОТДЕЛКА УМЫВАЛЬНЫХ РАКОВИН	<input checked="" type="checkbox"/> Krion® basin Lavabo in Krion® Умывальная раковина из Krion®	<input checked="" type="checkbox"/> Gel Coat basin Lavabo Gelcoat Раковина Gelcoat	<input checked="" type="checkbox"/> Ceramic basin Lavabo in ceramica Керамическая умывальная раковина
	<input checked="" type="checkbox"/> Natural Stone basin Lavabo in pietra naturale Умывальная раковина из натурального камня.		
<b>ACCESSORIES</b> ACCESSORI АКСЕССУАРЫ	<input type="checkbox"/> Mirror Specchio Зеркало	<input checked="" type="checkbox"/> Wall-mounted module Modulo sospeso Подвесной модуль	<input checked="" type="checkbox"/> Tall cabinet Modulo colonna Высокий шкаф
	<input type="checkbox"/> Upper unit Modulo alto Верхний модуль	<input type="checkbox"/> Organizer Organizzatore Органайзер	<input checked="" type="checkbox"/> Shelves Mensola Полка
			<input checked="" type="checkbox"/> Accessories Accessori Аксессуары



# side



Side is an absolutely symmetrical bathroom unit, conspicuous for its simplicity and excellence, with an innovative lateral drawer pull. The unit can be made to measure in any size and it comes in a wide variety of finishes (including lacquer, wood and laminate finishes). This ensures a variety of totally different designs able to fit in with bathrooms of all kinds, where it is all set to become a star feature.

Il mobile da bagno Side è perfettamente simmetrico e mira all'eccellenza della semplicità, con un design innovativo per quanto riguarda la maniglia spostata sul lato. Side può essere personalizzato in qualsiasi misura, ottenendo un arredo completamente diverso che si adatta a ogni tipo di bagno, diventandone l'elemento principale; è proposto con una grande assortimento di finiture tra lacca, legno e laminato.

Мебель для ванной комнаты Side отличается идеальной симметрией, все в ней стремится к совершенству и лаконичности. Ручка имеет новаторский дизайн: она расположена с боковой стороны. Side можно персонализировать по любым меркам, создавая очень разные варианты для каждого типа ванной, причем эта мебель всегда будет в главной роли. Имеется много возможностей для отделки, включая блестящий лак, дерево и ламинат.



+info p.382

2238 Points  
SIDE blanco emotions brillo



+info p.382

6520 Points  
SIDE blanco emotions brillo

# highline



+info p.382

10219 Points  
SIDE roble alba

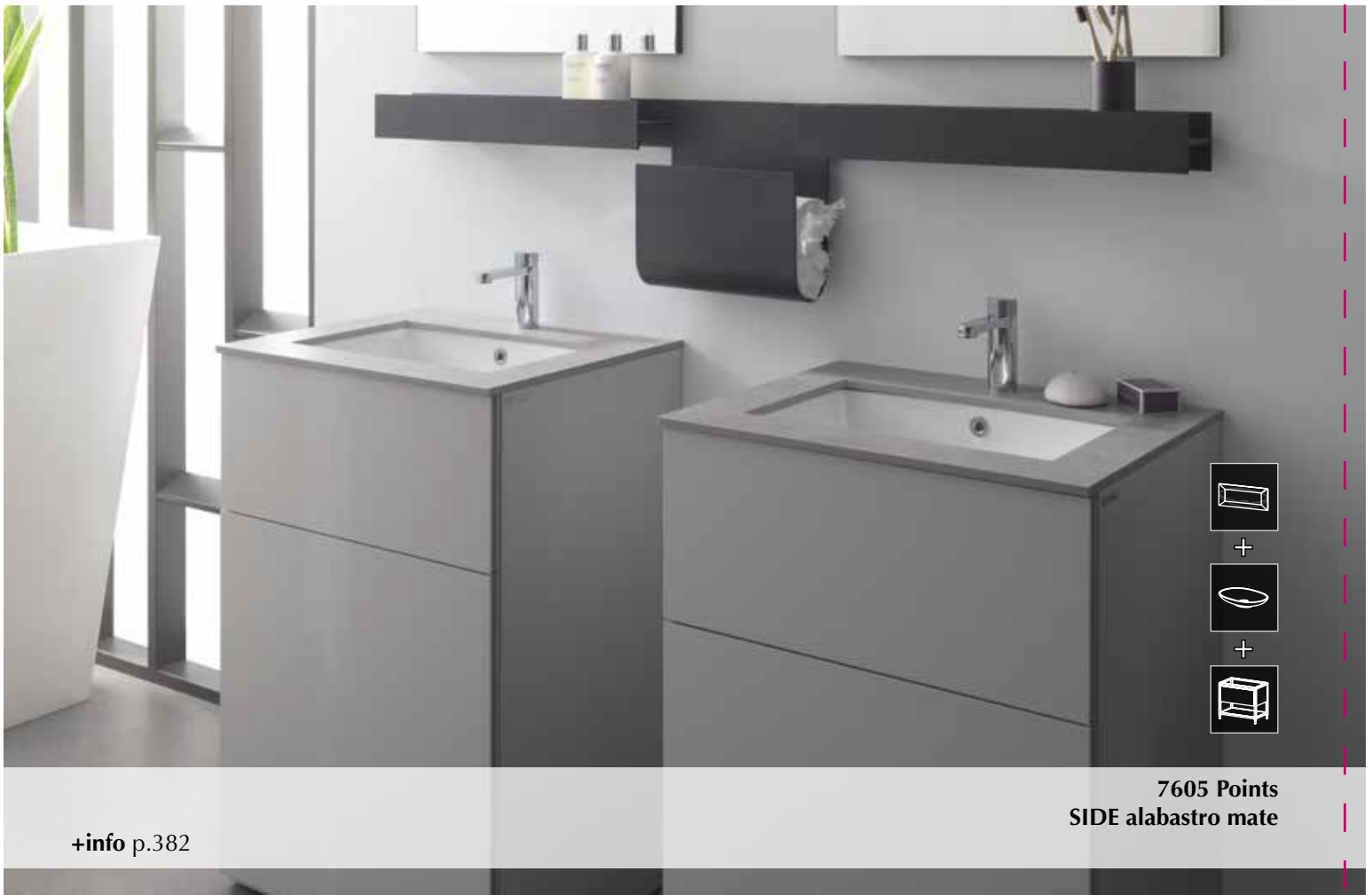

+info p.382

7605 Points  
SIDE alabastro mate

side

## FINISHES

GLOSS LACQUER / MATT LACQUER    LACCATO LUCIDO / LACCATO OPACO    ГЛЯНЦЕВЫЙ ЛАК / МАТОВЫЙ ЛАК



Ónix



Cromo



Férreo



Tórtola



Sílice



Bórax

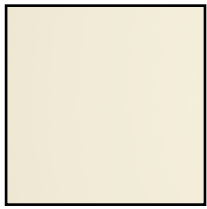

Cuarcita



Pizarra



Grafito

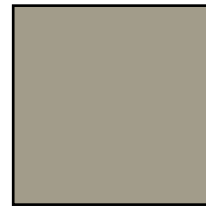

Plomo

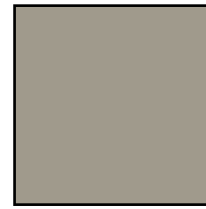

Limo



Pérgamon

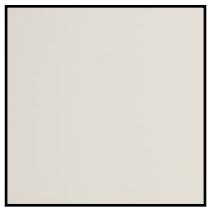

Alabastro

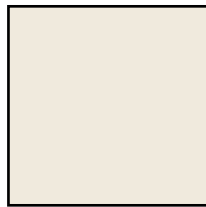

Porcelana



Negro Emotions



Ocean Blue



Azul Navy



Bottle

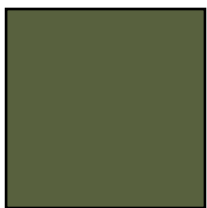

Orégano



Cúrcuma



Safrán



Curry



Blanco Snow

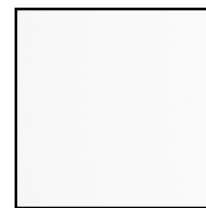

Blanco Emotions

## WOOD

## LEGNO

## ДЕРЕВО

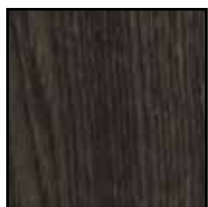

Roble Noche



Roble Cobre

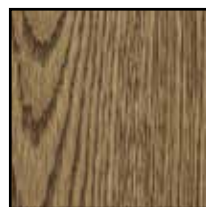

Roble Bronce



Roble Sil



Roble Alba



Roble torrefacto



Nogal seda

## FINISHES

LAMINATE

LAMINATO

ЛАМИНАТ



Eucalyptus Blond



Eucalyptus Gray



Eucalyptus Candy



Eucalyptus Smutty



Etimoe Ice



Etimoe Land



Etimoe Night



Nogal Moon



Clear



Coffee



Crust



Burn



Blanco Snow



Gris Hook Mate



Cement Mate



Storm Mate



Mouse Mate

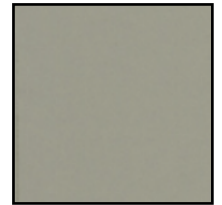

Topo Mate

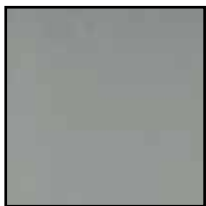

Wind



Marea

side

## WASH BASIN UNIT BPS-2001

DEPTH 48 CM / 18<sup>7</sup>/<sub>8</sub>"

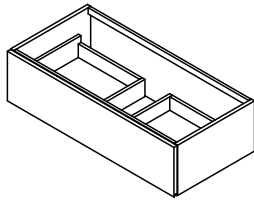

- Wash basin unit. For over mounted basin.
- Basi portalavabo. Per lavabo in appoggio.
- Тумбочка под умывальник. Для накладной раковины

MEASURES (x)x(x)x(x)	FINISHES	BASIN	SAP	POINTS
60x26x48 / 23 <sup>5</sup> / <sub>8</sub> x10 <sup>1</sup> / <sub>4</sub> x18 <sup>7</sup> / <sub>8</sub>	Gloss lacquer	CENTERED	700027732	0925
	Matt lacquer		700027731	0825
	Wood		700027733	1085
	Laminate		700027730	0706
80x26x48 / 31 <sup>1</sup> / <sub>2</sub> x10 <sup>1</sup> / <sub>4</sub> x18 <sup>7</sup> / <sub>8</sub>	Gloss lacquer	CENTERED / SX	700027736	1004
	Matt lacquer		700027735	0891
	Wood		700027737	1160
	Laminate		700027734	0752
90x26x48 / 35 <sup>3</sup> / <sub>8</sub> x10 <sup>1</sup> / <sub>4</sub> x18 <sup>7</sup> / <sub>8</sub>	Gloss lacquer	CENTERED	700027740	1035
	Matt lacquer		700027739	0916
	Wood		700027741	1195
	Laminate		700027738	0767
100x26x48 / 39 <sup>3</sup> / <sub>8</sub> x10 <sup>1</sup> / <sub>4</sub> x18 <sup>7</sup> / <sub>8</sub>	Gloss lacquer	CENTERED	700027744	1078
	Matt lacquer		700027743	0952
	Wood		700027745	1236
	Laminate		700027742	0793
120x26x48 / 47 <sup>1</sup> / <sub>4</sub> x10 <sup>1</sup> / <sub>4</sub> x18 <sup>7</sup> / <sub>8</sub>	Gloss lacquer	CENTERED / DX / SX	700027748	1138
	Matt lacquer		700027747	1003
	Wood		700027749	1325
	Laminate		700027746	0856

## WASH BASIN UNIT BPS-2009

DEPTH 48 CM / 18<sup>7</sup>/<sub>8</sub>"

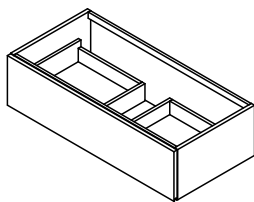

- Wash basin unit. For over mounted basin.
- Basi portalavabo. Per lavabo in appoggio.
- Тумбочка под умывальник. Для накладной раковины

MEASURES (x)x(x)x(x)	FINISHES	BASIN	SAP	POINTS
60-80x26x48 23 <sup>5</sup> / <sub>8</sub> -31 <sup>1</sup> / <sub>2</sub> x10 <sup>1</sup> / <sub>4</sub> x18 <sup>7</sup> / <sub>8</sub>	Gloss lacquer	CENTERED	700027828	1004
	Matt lacquer		700027827	0891
	Wood		700027829	1160
	Laminate		700027826	0752
>80-100x26x48 >31 <sup>1</sup> / <sub>2</sub> -39 <sup>3</sup> / <sub>8</sub> x10 <sup>1</sup> / <sub>4</sub> x18 <sup>7</sup> / <sub>8</sub>	Gloss lacquer	CENTERED	700027832	1078
	Matt lacquer		700027831	0952
	Wood		700027833	1236
	Laminate		700027830	0793
>100-120x26x48 39 <sup>3</sup> / <sub>8</sub> -47 <sup>1</sup> / <sub>4</sub> x10 <sup>1</sup> / <sub>4</sub> x18 <sup>7</sup> / <sub>8</sub>	Gloss lacquer	CENTERED	700027836	1138
	Matt lacquer		700027835	1003
	Wood		700027837	1325
	Laminate		700027834	0856

## WASH BASIN UNIT BPS-2003

DEPTH 48 CM / 18<sup>7/8</sup>"

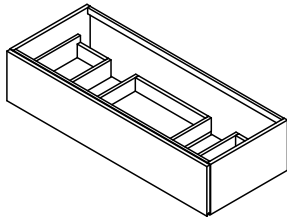

- Wash basin unit. For over mounted basin.
- Basi portalavabo. Per lavabo in appoggio.
- Тумбочка под умывальник. Для накладной раковины

MEASURES (x x x)	FINISHES	BASIN	SAP	POINTS
120x26x48 / 47 <sup>1/4</sup> x10 <sup>1/4</sup> x18 <sup>7/8</sup>	Gloss lacquer	DS	700027752	1198
	Matt lacquer		700027751	1063
	Wood		700027753	1390
	Laminate		700027750	0900

## WASH BASIN UNIT BPS-2002

DEPTH 48 CM / 18<sup>7/8</sup>"

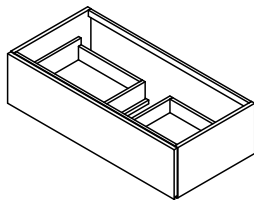

- Wash basin unit. For sotto basin.
- Basi portalavabo. Per lavabo sottotop.
- Тумбочка под умывальник. Для раковины Sotto



MEASURES (x x x)	FINISHES	BASIN	SAP	POINTS
60x26x48 / 23 <sup>5/8</sup> x10 <sup>1/4</sup> x18 <sup>7/8</sup>	Gloss lacquer	CENTERED	700027756	0963
	Matt lacquer		700027755	0863
	Wood		700027757	1127
	Laminate		700027754	0744
80x26x48 / 31 <sup>1/2</sup> x10 <sup>1/4</sup> x18 <sup>7/8</sup>	Gloss lacquer	CENTERED / SX	700027760	1040
	Matt lacquer		700027759	0928
	Wood		700027761	1200
	Laminate		700027758	0789
90x26x48 / 35 <sup>3/8</sup> x10 <sup>1/4</sup> x18 <sup>7/8</sup>	Gloss lacquer	CENTERED	700027764	1072
	Matt lacquer		700027763	0952
	Wood		700027765	1235
	Laminate		700027762	0803
100x26x48 / 39 <sup>3/8</sup> x10 <sup>1/4</sup> x18 <sup>7/8</sup>	Gloss lacquer	CENTERED	700027768	1115
	Matt lacquer		700027767	0989
	Wood		700027769	1276
	Laminate		700027766	0830
120x26x48 / 47 <sup>1/4</sup> x10 <sup>1/4</sup> x18 <sup>7/8</sup>	Gloss lacquer	CENTERED / DX / SX	700027772	1174
	Matt lacquer		700027771	1039
	Wood		700027773	1364
	Laminate		700027770	0877

BP

## WASH BASIN UNIT BPS-2010

DEPTH 48 CM / 18<sup>7</sup>/<sub>8</sub>"

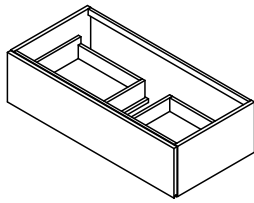

- Wash basin unit. For sotto basin.
- Basi portalavabo. Per lavabo sottotop.
- Тумбочка под умывальник. Для раковины Sotto

MEASURES (x)x(x)x(x)	FINISHES	BASIN	SAP	POINTS
60-80x26x48 23 <sup>5</sup> / <sub>8</sub> -31 <sup>1</sup> / <sub>2</sub> x10 <sup>1</sup> / <sub>4</sub> x18 <sup>7</sup> / <sub>8</sub>	Gloss lacquer	CENTERED	700027840	1040
	Matt lacquer		700027839	0928
	Wood		700027841	1200
	Laminate		700027838	0789
>80-100x26x48 >31 <sup>1</sup> / <sub>2</sub> -39 <sup>3</sup> / <sub>8</sub> x10 <sup>1</sup> / <sub>4</sub> x18 <sup>7</sup> / <sub>8</sub>	Gloss lacquer	CENTERED	700027844	1115
	Matt lacquer		700027843	0989
	Wood		700027845	1276
	Laminate		700027842	0830
>100-120x26x48 39 <sup>3</sup> / <sub>8</sub> -47 <sup>1</sup> / <sub>4</sub> x10 <sup>1</sup> / <sub>4</sub> x18 <sup>7</sup> / <sub>8</sub>	Gloss lacquer	CENTERED	700027848	1174
	Matt lacquer		700027847	1039
	Wood		700027849	1364
	Laminate		700027846	0877

## WASH BASIN UNIT BPS-2004

DEPTH 48 CM / 18<sup>7</sup>/<sub>8</sub>"

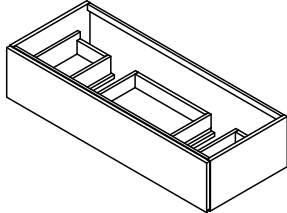

- Wash basin unit. For sotto basin.
- Basi portalavabo. Per lavabo sottotop.
- Тумбочка под умывальник. Для раковины Sotto

MEASURES (x)x(x)x(x)	FINISHES	BASIN	SAP	POINTS
120x26x48 / 47 <sup>1</sup> / <sub>4</sub> x10 <sup>1</sup> / <sub>4</sub> x18 <sup>7</sup> / <sub>8</sub>	Gloss lacquer	DS	700027776	1273
	Matt lacquer		700027775	1138
	Wood		700027777	1471
	Laminate		700027774	0975



## WASH BASIN UNIT BPS-2005

DEPTH 48 CM / 18<sup>7/8</sup>"

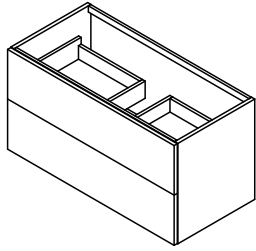

- Wash basin unit.
- Basi portalavabo.
- Тумбочка под умывальник.



MEASURES (x x x)	FINISHES	BASIN	SAP	POINTS
60x52x48 / 23 <sup>5/8</sup> x20 <sup>1/2</sup> x18 <sup>7/8</sup>	Gloss lacquer	CENTERED	700027780	1479
	Matt lacquer		700027779	1296
	Wood		700027781	1726
	Laminate		700027778	1063
80x52x48 / 31 <sup>1/2</sup> x20 <sup>1/2</sup> x18 <sup>7/8</sup>	Gloss lacquer	CENTERED / SX	700027784	1622
	Matt lacquer		700027783	1414
	Wood		700027785	1859
	Laminate		700027782	1137
90x52x48 / 35 <sup>3/8</sup> x20 <sup>1/2</sup> x18 <sup>7/8</sup>	Gloss lacquer	CENTERED	700027788	1684
	Matt lacquer		700027787	1463
	Wood		700027789	1929
	Laminate		700027786	1164
100x52x48 / 39 <sup>3/8</sup> x20 <sup>1/2</sup> x18 <sup>7/8</sup>	Gloss lacquer	CENTERED	700027792	1761
	Matt lacquer		700027791	1527
	Wood		700027793	2001
	Laminate		700027790	1206
120x52x48 / 47 <sup>1/4</sup> x20 <sup>1/2</sup> x18 <sup>7/8</sup>	Gloss lacquer	CENTERED / DX / SX	700027796	1866
	Matt lacquer		700027795	1613
	Wood		700027797	2162
	Laminate		700027794	1281

## WASH BASIN UNIT BPS-2011

DEPTH 48 CM / 18<sup>7/8</sup>"

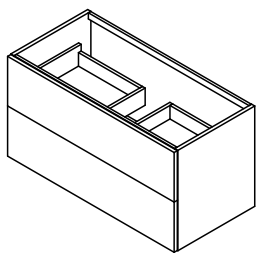

- Wash basin unit.
- Basi portalavabo.
- Тумбочка под умывальник.



MEASURES (x x x)	FINISHES	BASIN	SAP	POINTS
60-80x52x48 23 <sup>5/8</sup> -31 <sup>1/2</sup> x20 <sup>1/2</sup> x18 <sup>7/8</sup>	Gloss lacquer	CENTERED	700027852	1622
	Matt lacquer		700027851	1414
	Wood		700027853	1859
	Laminate		700027850	1137
>80-100x52x48 >31 <sup>1/2</sup> -39 <sup>3/8</sup> x20 <sup>1/2</sup> x18 <sup>7/8</sup>	Gloss lacquer	CENTERED	700027856	1761
	Matt lacquer		700027855	1527
	Wood		700027857	2001
	Laminate		700027854	1206
>100-120x52x48 39 <sup>3/8</sup> -47 <sup>1/4</sup> x20 <sup>1/2</sup> x18 <sup>7/8</sup>	Gloss lacquer	CENTERED	700027860	1866
	Matt lacquer		700027859	1613
	Wood		700027861	2162
	Laminate		700027858	1281

BP

## WASH BASIN UNIT BPS-2006

DEPTH 48 CM / 18<sup>7</sup>/<sub>8</sub>"

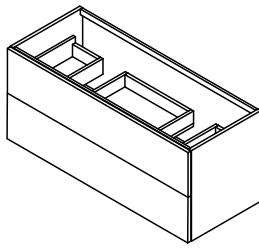

- Wash basin unit.
- Basi portalavabo.
- Тумбочка под умывальник.



MEASURES (x)x(x)x(x)	FINISHES	BASIN	SAP	POINTS
120x52x48 / 47 <sup>1</sup> / <sub>4</sub> x20 <sup>1</sup> / <sub>2</sub> x18 <sup>7</sup> / <sub>8</sub>	Gloss lacquer	DS	700027800	1926
	Matt lacquer		700027799	1674
	Wood		700027801	2227
	Laminate		700027798	1341

## WASH BASIN UNIT BPS-2007

DEPTH 48 CM / 18<sup>7</sup>/<sub>8</sub>"

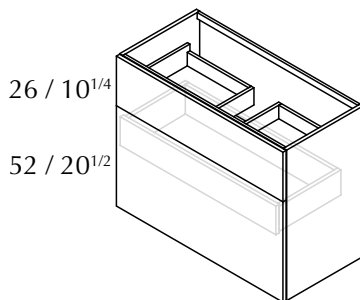

- Wash basin unit.
- Basi portalavabo.
- Тумбочка под умывальник.



MEASURES (x)x(x)x(x)	FINISHES	BASIN	SAP	POINTS
60x78x48 / 23 <sup>5</sup> / <sub>8</sub> x30 <sup>3</sup> / <sub>4</sub> x18 <sup>7</sup> / <sub>8</sub>	Gloss lacquer	CENTERED	700027804	1904
	Matt lacquer		700027803	1651
	Wood		700027805	2208
	Laminate		700027802	1362
80x78x48 / 31 <sup>1</sup> / <sub>2</sub> x30 <sup>3</sup> / <sub>4</sub> x18 <sup>7</sup> / <sub>8</sub>	Gloss lacquer	CENTERED / SX	700027808	2086
	Matt lacquer		700027807	1796
	Wood		700027809	2379
	Laminate		700027806	1449
90x78x48 / 35 <sup>3</sup> / <sub>8</sub> x30 <sup>3</sup> / <sub>4</sub> x18 <sup>7</sup> / <sub>8</sub>	Gloss lacquer	CENTERED	700027812	2174
	Matt lacquer		700027811	1866
	Wood		700027813	2476
	Laminate		700027810	1491
100x78x48 / 39 <sup>3</sup> / <sub>8</sub> x30 <sup>3</sup> / <sub>4</sub> x18 <sup>7</sup> / <sub>8</sub>	Gloss lacquer	CENTERED	700027816	2272
	Matt lacquer		700027815	1945
	Wood		700027817	2570
	Laminate		700027814	1542
120x78x48 / 47 <sup>1</sup> / <sub>4</sub> x30 <sup>3</sup> / <sub>4</sub> x18 <sup>7</sup> / <sub>8</sub>	Gloss lacquer	CENTERED / DX / SX	700027820	2437
	Matt lacquer		700027819	2081
	Wood		700027821	2791
	Laminate		700027818	1631

## WASH BASIN UNIT BPS-2012

DEPTH 48 CM / 18<sup>7/8</sup>"

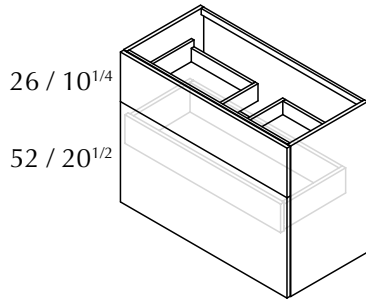

- Wash basin unit.
- Basi portalavabo.
- Тумбочка под умывальник.



MEASURES (x x x)	FINISHES	BASIN	SAP	POINTS
60-80x78x48 23 <sup>5/8</sup> -31 <sup>1/2</sup> x30 <sup>3/4</sup> x18 <sup>7/8</sup>	Gloss lacquer	CENTERED	700027864	2085
	Matt lacquer		700027863	1796
	Wood		700027865	2379
	Laminate		700027862	1449
>80-100x78x48 >31 <sup>1/2</sup> -39 <sup>3/8</sup> x30 <sup>3/4</sup> x18 <sup>7/8</sup>	Gloss lacquer	CENTERED	700027868	2272
	Matt lacquer		700027867	1945
	Wood		700027869	2570
	Laminate		700027866	1542
>100-120x78x48 39 <sup>3/8</sup> -47 <sup>1/4</sup> x30 <sup>3/4</sup> x18 <sup>7/8</sup>	Gloss lacquer	CENTERED	700027872	2437
	Matt lacquer		700027871	2081
	Wood		700027873	2791
	Laminate		700027870	1631

## WASH BASIN UNIT BPS-2008

DEPTH 48 CM / 18<sup>7/8</sup>"

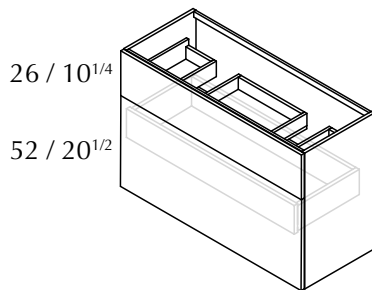

- Wash basin unit.
- Basi portalavabo.
- Тумбочка под умывальник.



MEASURES (x x x)	FINISHES	BASIN	SAP	POINTS
120x78x48 / 47 <sup>1/4</sup> x30 <sup>3/4</sup> x18 <sup>7/8</sup>	Gloss lacquer	DS	700027824	2497
	Matt lacquer		700027823	2141
	Wood		700027825	2856
	Laminate		700027822	1691

# side

WASH BASIN UNIT BPS-2027

DEPTH 48 CM / 18<sup>7</sup>/<sub>8</sub>"

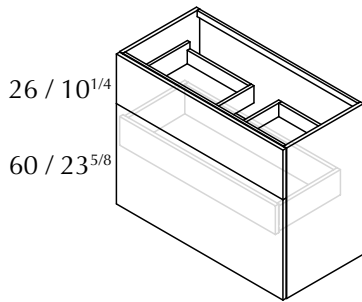

- Wash basin unit.
- Basi portalavabo.
- Тумбочка под умывальник.



MEASURES (x x x)	FINISHES	BASIN	SAP	POINTS
60x86x48 / 23 <sup>5</sup> / <sub>8</sub> x33 <sup>7</sup> / <sub>8</sub> x18 <sup>7</sup> / <sub>8</sub>	Gloss lacquer	CENTERED	700028006	1959
	Matt lacquer		700028007	1686
	Wood		700028009	2290
	Laminate		700028008	1388
80x86x48 / 31 <sup>1</sup> / <sub>2</sub> x33 <sup>7</sup> / <sub>8</sub> x18 <sup>7</sup> / <sub>8</sub>	Gloss lacquer	CENTERED / SX	700028010	2149
	Matt lacquer		700028011	1836
	Wood		700028013	2479
	Laminate		700028012	1477
90x86x48 / 35 <sup>3</sup> / <sub>8</sub> x33 <sup>7</sup> / <sub>8</sub> x18 <sup>7</sup> / <sub>8</sub>	Gloss lacquer	CENTERED	700028070	2243
	Matt lacquer		700028071	1907
	Wood		700028073	2585
	Laminate		700028072	1520
100x86x48 / 39 <sup>3</sup> / <sub>8</sub> x33 <sup>7</sup> / <sub>8</sub> x18 <sup>7</sup> / <sub>8</sub>	Gloss lacquer	CENTERED	700027998	2346
	Matt lacquer		700027999	1989
	Wood		700028001	2688
	Laminate		700028000	1572
120x86x48 / 47 <sup>1</sup> / <sub>4</sub> x33 <sup>7</sup> / <sub>8</sub> x18 <sup>7</sup> / <sub>8</sub>	Gloss lacquer	CENTERED / DX / SX	700028002	2519
	Matt lacquer		700028003	2130
	Wood		700028005	2927
	Laminate		700028004	1663

## WASH BASIN UNIT BPS-2029

DEPTH 48 CM / 18<sup>7/8</sup>"

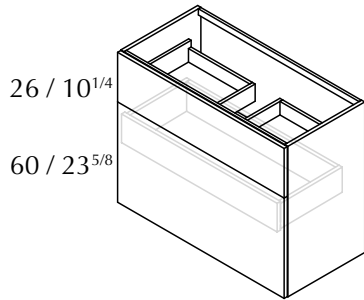

- Wash basin unit.
- Basi portalavabo.
- Тумбочка под умывальник.



MEASURES (x x x)	FINISHES	BASIN	SAP	POINTS
60-80x86x48 23 <sup>5/8</sup> -31 <sup>1/2</sup> x33 <sup>7/8</sup> x18 <sup>7/8</sup>	Gloss lacquer	CENTERED	700028022	2149
	Matt lacquer		700028023	1836
	Wood		700028025	2479
	Laminate		700028024	1477
>80-100x86x48 >31 <sup>1/2</sup> -39 <sup>3/8</sup> x33 <sup>7/8</sup> x18 <sup>7/8</sup>	Gloss lacquer	CENTERED	700028026	2346
	Matt lacquer		700028027	1989
	Wood		700028029	2688
	Laminate		700028028	1572
>100-120x86x48 39 <sup>3/8</sup> -47 <sup>1/4</sup> x33 <sup>7/8</sup> x18 <sup>7/8</sup>	Gloss lacquer	CENTERED	700028018	2519
	Matt lacquer		700028019	2130
	Wood		700028021	2927
	Laminate		700028020	1663

## WASH BASIN UNIT BPS-2028

DEPTH 48 CM / 18<sup>7/8</sup>"

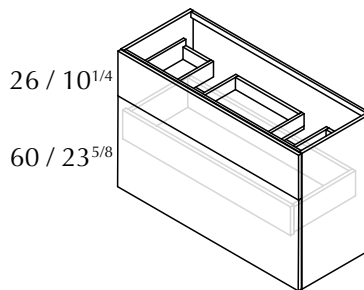

- Wash basin unit.
- Basi portalavabo.
- Тумбочка под умывальник.



MEASURES (x x x)	FINISHES	BASIN	SAP	POINTS
120x86x48 / 47 <sup>1/4</sup> x33 <sup>7/8</sup> x18 <sup>7/8</sup>	Gloss lacquer	DS	700028014	2579
	Matt lacquer		700028015	2190
	Wood		700028017	2992
	Laminate		700028016	1724

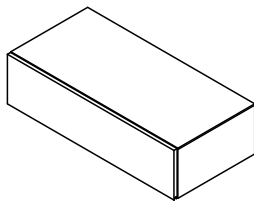

Wallmounted unit.

Modulo sospeso.

Тумба для ванной, монтируемая на стену.

MEASURES		FINISHES	SAP	POINTS
45x26x48 / 17 <sup>3/4</sup> x10 <sup>1/4</sup> x18 <sup>7/8</sup>		Gloss lacquer	700027876	0870
		Matt lacquer	700027875	0736
		Wood	700027877	1047
		Laminate	700027874	0612
60x26x48 / 23 <sup>5/8</sup> x10 <sup>1/4</sup> x18 <sup>7/8</sup>		Gloss lacquer	700027880	0949
		Matt lacquer	700027879	0794
		Wood	700027881	1122
		Laminate	700027878	0649
80x26x48 / 31 <sup>1/2</sup> x10 <sup>1/4</sup> x18 <sup>7/8</sup>		Gloss lacquer	700027884	1052
		Matt lacquer	700027883	0871
		Wood	700027885	1232
		Laminate	700027882	0707
90x26x48 / 35 <sup>3/8</sup> x10 <sup>1/4</sup> x18 <sup>7/8</sup>		Gloss lacquer	700027888	1101
		Matt lacquer	700027887	0907
		Wood	700027889	1285
		Laminate	700027886	0729
100x26x48 / 39 <sup>3/8</sup> x10 <sup>1/4</sup> x18 <sup>7/8</sup>		Gloss lacquer	700027892	1159
		Matt lacquer	700027891	0951
		Wood	700027893	1341
		Laminate	700027890	0761
120x26x48 / 47 <sup>1/4</sup> x10 <sup>1/4</sup> x18 <sup>7/8</sup>		Gloss lacquer	700027896	1246
		Matt lacquer	700027895	1014
		Wood	700027897	1458
		Laminate	700027894	0816

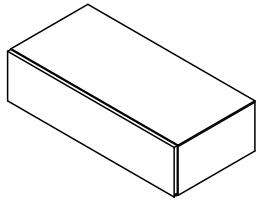

Wallmounted unit.

Modulo sospeso.

Тумба для ванной, монтируемая на стену.

MEASURES	(x x x)	FINISHES	SAP	POINTS
45-60x26x48 17 <sup>3/4</sup> -23 <sup>5/8</sup> x10 <sup>1/4</sup> x18 <sup>7/8</sup>		Gloss lacquer	700027948	0949
		Matt lacquer	700027947	0794
		Wood	700027949	1122
		Laminate	700027946	0649
>60-80x26x48 >23 <sup>5/8</sup> -31 <sup>1/2</sup> x10 <sup>1/4</sup> x18 <sup>7/8</sup>		Gloss lacquer	700027952	1052
		Matt lacquer	700027951	0871
		Wood	700027953	1232
		Laminate	700027950	0707
>80-100x26x48 >31 <sup>1/2</sup> -39 <sup>3/8</sup> x10 <sup>1/4</sup> x18 <sup>7/8</sup>		Gloss lacquer	700027956	1159
		Matt lacquer	700027955	0951
		Wood	700027957	1341
		Laminate	700027954	0761
>100-120x26x48 39 <sup>3/8</sup> -47 <sup>1/4</sup> x10 <sup>1/4</sup> x18 <sup>7/8</sup>		Gloss lacquer	700027960	1246
		Matt lacquer	700027959	1014
		Wood	700027961	1458
		Laminate	700027958	0816

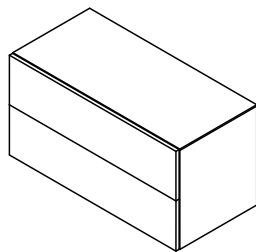

Wallmounted unit.

Modulo sospeso.

Тумба для ванной, монтируемая на стену.

MEASURES	(  )	FINISHES	SAP	POINTS
45x52x48 / 17 <sup>3/4</sup> x20 <sup>1/2</sup> x18 <sup>7/8</sup>		Gloss lacquer	700027900	1380
		Matt lacquer	700027899	1173
		Wood	700027901	1648
		Laminate	700027898	0958
60x52x48 / 23 <sup>5/8</sup> x20 <sup>1/2</sup> x18 <sup>7/8</sup>		Gloss lacquer	700027904	1508
		Matt lacquer	700027903	1271
		Wood	700027905	1768
		Laminate	700027902	1019
80x52x48 / 31 <sup>1/2</sup> x20 <sup>1/2</sup> x18 <sup>7/8</sup>		Gloss lacquer	700027908	1682
		Matt lacquer	700027907	1406
		Wood	700027909	1943
		Laminate	700027906	1114
90x52x48 / 35 <sup>3/8</sup> x20 <sup>1/2</sup> x18 <sup>7/8</sup>		Gloss lacquer	700027912	1762
		Matt lacquer	700027911	1466
		Wood	700027913	2032
		Laminate	700027910	1151
100x52x48 / 39 <sup>3/8</sup> x20 <sup>1/2</sup> x18 <sup>7/8</sup>		Gloss lacquer	700027916	1855
		Matt lacquer	700027915	1539
		Wood	700027917	2120
		Laminate	700027914	1200
120x52x48 / 47 <sup>1/4</sup> x20 <sup>1/2</sup> x18 <sup>7/8</sup>		Gloss lacquer	700027920	1989
		Matt lacquer	700027919	1640
		Wood	700027921	2311
		Laminate	700027918	1289



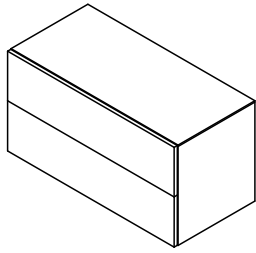

Wallmounted unit.

Modulo sospeso.

Тумба для ванной, монтируемая на стену.

MEASURES	(xx)	FINISHES	SAP	POINTS
45-60x52x48 17 <sup>3/4</sup> -23 <sup>5/8</sup> x20 <sup>1/2</sup> x18 <sup>7/8</sup>		Gloss lacquer	700027964	1508
		Matt lacquer	700027963	1271
		Wood	700027965	1768
		Laminate	700027962	1019
>60-80x52x48 >23 <sup>5/8</sup> -31 <sup>1/2</sup> x20 <sup>1/2</sup> x18 <sup>7/8</sup>		Gloss lacquer	700027968	1682
		Matt lacquer	700027967	1406
		Wood	700027969	1943
		Laminate	700027966	1114
>80-100x52x48 >31 <sup>1/2</sup> -39 <sup>3/8</sup> x20 <sup>1/2</sup> x18 <sup>7/8</sup>		Gloss lacquer	700027972	1855
		Matt lacquer	700027971	1539
		Wood	700027973	2120
		Laminate	700027970	1200
>100-120x52x48 39 <sup>3/8</sup> -47 <sup>1/4</sup> x20 <sup>1/2</sup> x18 <sup>7/8</sup>		Gloss lacquer	700027976	1989
		Matt lacquer	700027975	1640
		Wood	700027977	2311
		Laminate	700027974	1289

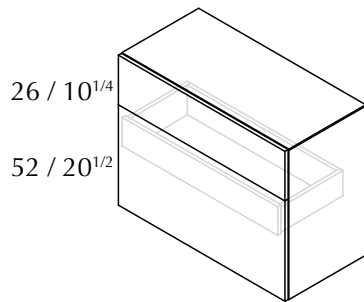

Wallmounted unit.

Modulo sospeso.

Тумба для ванной, монтируемая на стену.

MEASURES	()	FINISHES	SAP	POINTS
45x78x48 / 17 <sup>3</sup> / <sub>4</sub> x30 <sup>3</sup> / <sub>4</sub> x18 <sup>7</sup> / <sub>8</sub>		Gloss lacquer	700027924	1798
		Matt lacquer	700027923	1527
		Wood	700027925	2097
		Laminate	700027922	1258
60x78x48 / 23 <sup>5</sup> / <sub>8</sub> x30 <sup>3</sup> / <sub>4</sub> x18 <sup>7</sup> / <sub>8</sub>		Gloss lacquer	700027928	1943
		Matt lacquer	700027927	1635
		Wood	700027929	2261
		Laminate	700027926	1335
80x78x48 / 31 <sup>1</sup> / <sub>2</sub> x30 <sup>3</sup> / <sub>4</sub> x18 <sup>7</sup> / <sub>8</sub>		Gloss lacquer	700027932	2152
		Matt lacquer	700027931	1795
		Wood	700027933	2471
		Laminate	700027930	1444
90x78x48 / 35 <sup>3</sup> / <sub>8</sub> x30 <sup>3</sup> / <sub>4</sub> x18 <sup>7</sup> / <sub>8</sub>		Gloss lacquer	700027936	2265
		Matt lacquer	700027935	1882
		Wood	700027937	2593
		Laminate	700027934	1503
100x78x48 / 39 <sup>3</sup> / <sub>8</sub> x30 <sup>3</sup> / <sub>4</sub> x18 <sup>7</sup> / <sub>8</sub>		Gloss lacquer	700027940	2379
		Matt lacquer	700027939	1970
		Wood	700027941	2703
		Laminate	700027938	1564
120x78x48 / 47 <sup>1</sup> / <sub>4</sub> x30 <sup>3</sup> / <sub>4</sub> x18 <sup>7</sup> / <sub>8</sub>		Gloss lacquer	700027944	2575
		Matt lacquer	700027943	2122
		Wood	700027945	2956
		Laminate	700027942	1669

## FREESTANDING UNIT MS-2018

DEPTH 48 CM / 18<sup>7</sup>/<sub>8</sub>"

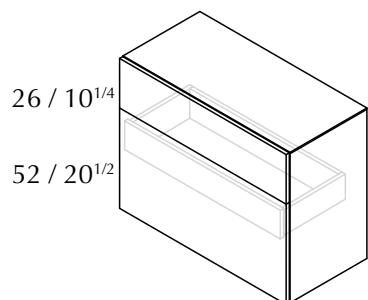

Wallmounted unit.

Modulo sospeso.

Тумба для ванной, монтируемая на стену.

MEASURES	(↔x↑x↗)	FINISHES	SAP	POINTS
45-60x78x48 17 <sup>3</sup> / <sub>4</sub> -23 <sup>5</sup> / <sub>8</sub> x30 <sup>3</sup> / <sub>4</sub> x18 <sup>7</sup> / <sub>8</sub>		Gloss lacquer	700027980	1943
		Matt lacquer	700027979	1635
		Wood	700027981	2261
		Laminate	700027978	1335
>60-80x78x48 >23 <sup>5</sup> / <sub>8</sub> -31 <sup>1</sup> / <sub>2</sub> x30 <sup>3</sup> / <sub>4</sub> x18 <sup>7</sup> / <sub>8</sub>		Gloss lacquer	700027984	2152
		Matt lacquer	700027983	1795
		Wood	700027985	2471
		Laminate	700027982	1444
>80-100x78x48 >31 <sup>1</sup> / <sub>2</sub> -39 <sup>3</sup> / <sub>8</sub> x30 <sup>3</sup> / <sub>4</sub> x18 <sup>7</sup> / <sub>8</sub>		Gloss lacquer	700027988	2379
		Matt lacquer	700027987	1970
		Wood	700027989	2703
		Laminate	700027986	1564
>100-120x78x48 39 <sup>3</sup> / <sub>8</sub> -47 <sup>1</sup> / <sub>4</sub> x30 <sup>3</sup> / <sub>4</sub> x18 <sup>7</sup> / <sub>8</sub>		Gloss lacquer	700027992	2575
		Matt lacquer	700027991	2122
		Wood	700027993	2956
		Laminate	700027990	1669

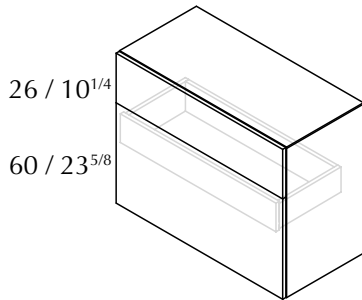

Wallmounted unit.

Modulo sospeso.

Тумба для ванной, монтируемая на стену.

MEASURES	(  )	FINISHES	SAP	POINTS
45x86x48 / 17 <sup>3</sup> / <sub>4</sub> x33 <sup>7</sup> / <sub>8</sub> x18 <sup>7</sup> / <sub>8</sub>		Gloss lacquer	700028038	1847
		Matt lacquer	700028039	1558
		Wood	700028041	2167
		Laminate	700028040	1284
60x86x48 / 23 <sup>5</sup> / <sub>8</sub> x33 <sup>7</sup> / <sub>8</sub> x18 <sup>7</sup> / <sub>8</sub>		Gloss lacquer	700028042	1997
		Matt lacquer	700028043	1669
		Wood	700028045	2344
		Laminate	700028044	1365
80x86x48 / 31 <sup>1</sup> / <sub>2</sub> x33 <sup>7</sup> / <sub>8</sub> x18 <sup>7</sup> / <sub>8</sub>		Gloss lacquer	700028046	2220
		Matt lacquer	700028047	1836
		Wood	700028049	2576
		Laminate	700028048	1481
90x86x48 / 35 <sup>3</sup> / <sub>8</sub> x33 <sup>7</sup> / <sub>8</sub> x18 <sup>7</sup> / <sub>8</sub>		Gloss lacquer	700028050	2333
		Matt lacquer	700028051	1925
		Wood	700028053	2702
		Laminate	700028052	1537
100x86x48 / 39 <sup>3</sup> / <sub>8</sub> x33 <sup>7</sup> / <sub>8</sub> x18 <sup>7</sup> / <sub>8</sub>		Gloss lacquer	700028030	2452
		Matt lacquer	700028031	2013
		Wood	700028033	2822
		Laminate	700028032	1599
120x86x48 / 47 <sup>1</sup> / <sub>4</sub> x33 <sup>7</sup> / <sub>8</sub> x18 <sup>7</sup> / <sub>8</sub>		Gloss lacquer	700028034	2660
		Matt lacquer	700028035	2174
		Wood	700028037	3096
		Laminate	700028036	1713

## FREESTANDING UNIT MS-2031

DEPTH 48 CM / 18<sup>7/8</sup>"

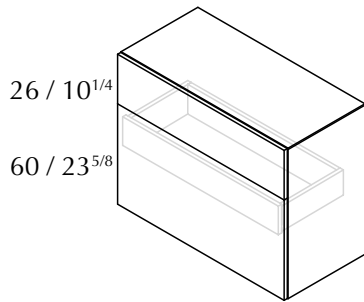

Wallmounted unit.

Modulo sospeso.

Тумба для ванной, монтируемая на стену.

MEASURES	(x) (x) (x)	FINISHES	SAP	POINTS
45-60x86x48 17 <sup>3/4</sup> -23 <sup>5/8</sup> x33 <sup>7/8</sup> x18 <sup>7/8</sup>		Gloss lacquer	700028058	1997
		Matt lacquer	700028059	1669
		Wood	700028061	2344
		Laminate	700028060	1365
>60-80x86x48 >23 <sup>5/8</sup> -31 <sup>1/2</sup> x33 <sup>7/8</sup> x18 <sup>7/8</sup>		Gloss lacquer	700028062	2220
		Matt lacquer	700028063	1836
		Wood	700028065	2576
		Laminate	700028064	1481
>80-100x86x48 >31 <sup>1/2</sup> -39 <sup>3/8</sup> x33 <sup>7/8</sup> x18 <sup>7/8</sup>		Gloss lacquer	700028066	2452
		Matt lacquer	700028067	2013
		Wood	700028069	2822
		Laminate	700028068	1599
>100-120x86x48 39 <sup>3/8</sup> -47 <sup>1/4</sup> x33 <sup>7/8</sup> x18 <sup>7/8</sup>		Gloss lacquer	700028054	2660
		Matt lacquer	700028055	2174
		Wood	700028057	3096
		Laminate	700028056	1713

side

MS

## PEANA 2026

DEPTH 48 CM / 18<sup>7/8</sup>"

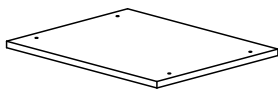

Optional base. For BPS-2007, BPS-2008 y BPS-2012 over mounted sink or BPS-2027, BPS-2028 and BPS-2029 with Sotto Box sink.

Mensola opzionale per: BPS-2007, BPS-2008, BPS-2012 con lavabo da appoggio sopra top. Oppure: BPS-2027, BPS-2028, BPS-2029 con lavabo sotto piano.

База опциональная. Для BPS-2007, BPS-2008 y BPS-2012 с раковиной на столешнице или BPS-2027, BPS-2028 y BPS-2029 с раковиной под столешницу (sotto).

MEASURES	(x) (x) (x)	FINISHES	SAP	POINTS
45-60x2x48 17 <sup>3/4</sup> -23 <sup>5/8</sup> x0 <sup>3/4</sup> x18 <sup>7/8</sup>		Gloss lacquer	700026638	0172
		Matt lacquer	700026637	0114
		Wood	700026639	0189
		Laminate	700026636	0077
>60-80x2x48 >23 <sup>5/8</sup> -31 <sup>1/2</sup> x0 <sup>3/4</sup> x18 <sup>7/8</sup>		Gloss lacquer	700026642	0205
		Matt lacquer	700026641	0134
		Wood	700026643	0231
		Laminate	700026640	0094
>80-100x2x48 >31 <sup>1/2</sup> -39 <sup>3/8</sup> x0 <sup>3/4</sup> x18 <sup>7/8</sup>		Gloss lacquer	700026650	0242
		Matt lacquer	700026649	0156
		Wood	700026651	0268
		Laminate	700026648	0108
>100-120x2x48 >39 <sup>3/8</sup> -47 <sup>1/4</sup> x0 <sup>3/4</sup> x18 <sup>7/8</sup>		Gloss lacquer	700026654	0280
		Matt lacquer	700026653	0178
		Wood	700026655	0305
		Laminate	700026652	0122

CM

# side

MSC 2019

DEPTH 30 CM / 11<sup>3</sup>/<sub>4</sub>"

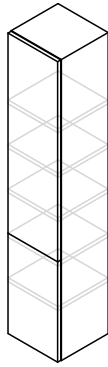

Tower unit with door. DX / SX.

Modulo colonna con anta. DX / SX.

Вертикальный блок с дверцей. DX / SX.

MEASURES	(  )	FINISHES	SAP	POINTS
30x156x30 / 11 <sup>3</sup> / <sub>4</sub> x61 <sup>3</sup> / <sub>8</sub> x11 <sup>3</sup> / <sub>4</sub>		Gloss lacquer	700027996	1396
		Matt lacquer	700027995	1073
		Wood	700027997	1652
		Laminate	700027994	0773

MC

## LIGHT

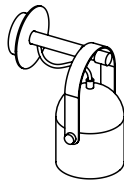

MEASURES	(  )	FINISHES	SAP	POINTS
11,7x21,8x14,4 / 4 <sup>5</sup> / <sub>8</sub> x8 <sup>5</sup> / <sub>8</sub> x5 <sup>5</sup> / <sub>8</sub>		Metal. 220V. E27 ( <b>Bombilla no incluida</b> ).	100278351	0195

## ROD

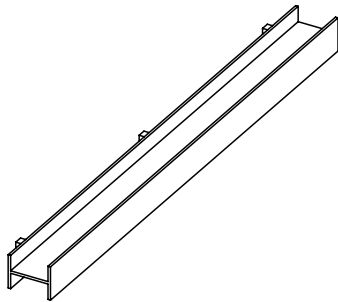

MEASURES	(  )	FINISHES	SAP	POINTS
30x8x10 / 11 <sup>3</sup> / <sub>4</sub> x 3 <sup>1</sup> / <sub>8</sub> x3 <sup>7</sup> / <sub>8</sub>		Metal	100278336	0327
45x8x10 / 17 <sup>3</sup> / <sub>4</sub> x 3 <sup>1</sup> / <sub>8</sub> x3 <sup>7</sup> / <sub>8</sub>			100278337	0344
60x8x10 / 23 <sup>5</sup> / <sub>8</sub> x 3 <sup>1</sup> / <sub>8</sub> x3 <sup>7</sup> / <sub>8</sub>			100278338	0461
90x8x10 / 35 <sup>3</sup> / <sub>8</sub> x 3 <sup>1</sup> / <sub>8</sub> x3 <sup>7</sup> / <sub>8</sub>			100278339	0579
120x8x10 / 47 <sup>1</sup> / <sub>4</sub> x 3 <sup>1</sup> / <sub>8</sub> x3 <sup>7</sup> / <sub>8</sub>			100278309	0777
135x8x10 / 53 <sup>1</sup> / <sub>8</sub> x 3 <sup>1</sup> / <sub>8</sub> x3 <sup>7</sup> / <sub>8</sub>			100278330	0858
150x8x10 / 59x 3 <sup>1</sup> / <sub>8</sub> x3 <sup>7</sup> / <sub>8</sub>			100278331	0926
180x8x10 / 70 <sup>7</sup> / <sub>8</sub> x 3 <sup>1</sup> / <sub>8</sub> x3 <sup>7</sup> / <sub>8</sub>			100278332	1046
210x8x10 / 82 <sup>5</sup> / <sub>8</sub> x 3 <sup>1</sup> / <sub>8</sub> x3 <sup>7</sup> / <sub>8</sub>			100278333	1237
225x8x10 / 88 <sup>5</sup> / <sub>8</sub> x 3 <sup>1</sup> / <sub>8</sub> x3 <sup>7</sup> / <sub>8</sub>			100278334	1288
240x8x10 / 94 <sup>1</sup> / <sub>2</sub> x 3 <sup>1</sup> / <sub>8</sub> x3 <sup>7</sup> / <sub>8</sub>			100278335	1369

CM

## TOWEL

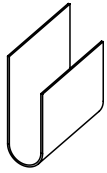

MEASURES	(xx)	FINISHES	SAP	POINTS
30x30x10 / 11 <sup>3/4</sup> x11 <sup>3/4</sup> x3 <sup>7/8</sup>		Metal	100278348	0321

## TOOTHBRUSH HOLDER



MEASURES	(xx)	FINISHES	SAP	POINTS
15x20x14,4 / 5 <sup>7/8</sup> x7 <sup>7/8</sup> x5 <sup>5/8</sup>		Roble puro	100278340	0038

## TOOTHBRUSH HOLDER

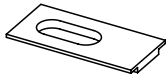

MEASURES	(xx)	FINISHES	SAP	POINTS
30x20x14,4 / 11 <sup>3/4</sup> x7 <sup>7/8</sup> x5 <sup>5/8</sup>		Roble puro	100278341	0050

## SHELF



MEASURES	(xx)	FINISHES	SAP	POINTS
15x20x14,4 / 5 <sup>7/8</sup> x7 <sup>7/8</sup> x5 <sup>5/8</sup>		Roble puro	100278344	0026
30x20x14,4 / 11 <sup>3/4</sup> x7 <sup>7/8</sup> x5 <sup>5/8</sup>			100278345	0050

## SOAP SHELF



MEASURES	(xx)	FINISHES	SAP	POINTS
15x20x14,4 / 5 <sup>7/8</sup> x7 <sup>7/8</sup> x5 <sup>5/8</sup>		Roble puro	100278346	0038

## SOAP SHELF



MEASURES	(xx)	FINISHES	SAP	POINTS
30x20x14,4 / 11 <sup>3/4</sup> x7 <sup>7/8</sup> x5 <sup>5/8</sup>		Roble puro	100278347	0050

## SHELF

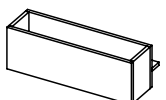

MEASURES	(xx)	FINISHES	SAP	POINTS
15x10x10 / 5 <sup>7/8</sup> x3 <sup>7/8</sup> x3 <sup>7/8</sup>		Roble puro	100278342	0063
30x10x10 / 11 <sup>3/4</sup> x3 <sup>7/8</sup> x3 <sup>7/8</sup>			100278343	0087

# side

## SLIM BASIN

DEPTH 49CM / 19<sup>1</sup>/<sub>4</sub>"

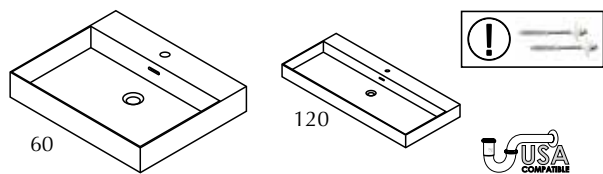

- GELCOAT basin with overflow.
- Requires for installation valve SAP100200010, 72 P.
- Lavabo GELCOAT con troppopieno.
- Richiede valvola SAP100200010, 72 P.
- Раковина GELCOAT с переливом.
- Требуется установка клапана SAP100200010, 72 P.

MEASURES	FINISHES	SAP	POINTS
60x10x49 / 23 <sup>5</sup> / <sub>8</sub> x3 <sup>7</sup> / <sub>8</sub> x19 <sup>1</sup> / <sub>4</sub>	GELCOAT	100221199	596
80x10x49 / 31 <sup>1</sup> / <sub>2</sub> x3 <sup>7</sup> / <sub>8</sub> x19 <sup>1</sup> / <sub>4</sub>		100221201	682
90x10x49 / 35 <sup>3</sup> / <sub>8</sub> x3 <sup>7</sup> / <sub>8</sub> x19 <sup>1</sup> / <sub>4</sub>		100221203	765
100x10x49 / 39 <sup>3</sup> / <sub>8</sub> x3 <sup>7</sup> / <sub>8</sub> x19 <sup>1</sup> / <sub>4</sub>		100241700	784
120x10x49 / 47 <sup>1</sup> / <sub>4</sub> x3 <sup>7</sup> / <sub>8</sub> x19 <sup>1</sup> / <sub>4</sub>		100221205	822
① FIXINGS / ANCLAJE PARED. 60/80/90/100 (1UND.) - 120 (2UNDS.)		250010391	9

## SLIM BASIN

### COUNTERTOP / SOBRE ENCIMERA / VASQUE SUR PLAN

REQUIRES WORKTOP

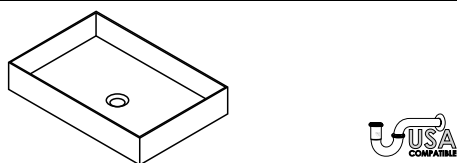

- GELCOAT basin. **REQUIRES WORKTOP.**
- Requires for installation valve SAP100036254, 68 P.
- Lavabo GELCOAT. **RICHIEDE TOP IN.**
- Richiede valvola SAP100036254, 68 P.
- Раковина GELCOAT. **НУЖДАЕТСЯ В СТОЛЕШНИЦЕ.**
- Требуется установка клапана SAP100036254, 68 P.

MEASURES	FINISHES	SAP	POINTS
50x10x33 / 19 <sup>5</sup> / <sub>8</sub> x3 <sup>7</sup> / <sub>8</sub> x13	GELCOAT	100221198	475

## SOTTO NOVA

### RECESSED SINK



- Ceramic basin. **REQUIRES WORKTOP.**
- Lavabo in ceramica. **RICHIEDE TOP.**
- Керамическая раковина. **НУЖДАЕТСЯ В СТОЛЕШНИЦЕ.**

MEASURES	FINISHES	SAP	POINTS
50x14,2x34 / 19 <sup>5</sup> / <sub>8</sub> x5 <sup>5</sup> / <sub>8</sub> x13 <sup>3</sup> / <sub>8</sub>	White ceramic	100241696	253
62x14,2x34 / 24 <sup>3</sup> / <sub>8</sub> x5 <sup>5</sup> / <sub>8</sub> x13 <sup>3</sup> / <sub>8</sub>		100286592	370

## FIT BASIN

DEPTH 49CM / 19<sup>1</sup>/<sub>4</sub>"

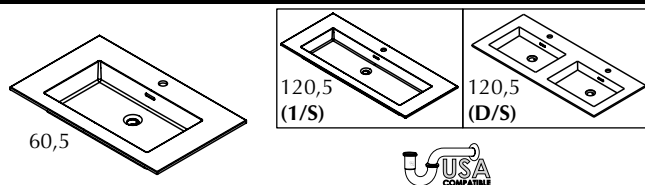

- GELCOAT basin with overflow.
- Requires for installation valve SAP100200010, 72 P.
- Lavabo GELCOAT con troppopieno.
- Richiede valvola SAP100200010, 72 P.
- Раковина GELCOAT с переливом.
- Требуется установка клапана SAP100200010, 72 P.

MEASURES	FINISHES	SAP	POINTS
60,5x13,5x49 / 23 <sup>7</sup> / <sub>8</sub> x5 <sup>3</sup> / <sub>8</sub> x19 <sup>1</sup> / <sub>4</sub>	GELCOAT	100241712	427
80,5x13,5x49 / 31 <sup>3</sup> / <sub>4</sub> x5 <sup>3</sup> / <sub>8</sub> x19 <sup>1</sup> / <sub>4</sub>		100241723	532
90,5x13,5x49 / 35 <sup>5</sup> / <sub>8</sub> x5 <sup>3</sup> / <sub>8</sub> x19 <sup>1</sup> / <sub>4</sub>		100241702	596
100,5x13,5x49 / 39 <sup>5</sup> / <sub>8</sub> x5 <sup>3</sup> / <sub>8</sub> x19 <sup>1</sup> / <sub>4</sub>		100241627	659
120,5x13,5x49 / 47 <sup>1</sup> / <sub>2</sub> x5 <sup>3</sup> / <sub>8</sub> x19 <sup>1</sup> / <sub>4</sub> (1/S)		100241693	794
120,5x13,5x49 / 47 <sup>1</sup> / <sub>2</sub> x5 <sup>3</sup> / <sub>8</sub> x19 <sup>1</sup> / <sub>4</sub> (D/S)		100296392	898

## ONES BASIN SEMI-RECESSED

DEPTH 48CM / 18<sup>7</sup>/<sub>8</sub>"

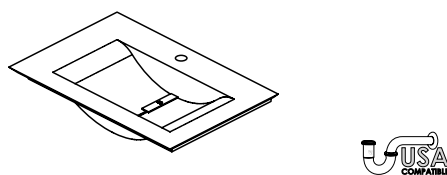

- GELCOAT basin. **REQUIRES WORKTOP.**
- Lavabo GELCOAT. **RICHIEDE TOP IN.**
- Раковина GELCOAT. **НУЖДАЕТСЯ В СТОЛЕШНИЦЕ.**

- Optional black plate (250055696 / 150 points).
- Copripiletta nero opzionale (250055696 / 150 punti).
- Опционально черная накладка (250055696 / 150 пунктов).

MEASURES	FINISHES	SAP	POINTS
60x13x48 / 23 <sup>5</sup> / <sub>8</sub> x5 <sup>1</sup> / <sub>8</sub> x18 <sup>7</sup> / <sub>8</sub>	GELCOAT	100110452	0942
71,5x13x48 / 28 <sup>1</sup> / <sub>8</sub> x5 <sup>1</sup> / <sub>8</sub> x18 <sup>7</sup> / <sub>8</sub>		100100508	0982
115x13x48 / 45 <sup>1</sup> / <sub>4</sub> x5 <sup>1</sup> / <sub>8</sub> x18 <sup>7</sup> / <sub>8</sub>		100100507	1202



## CICLO BASIN SEMI-RECESSED

DEPTH 48CM / 18<sup>7/8</sup>"

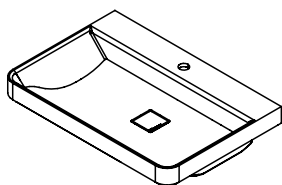

- GELCOAT basin. **REQUIRES WORKTOP.**
- It requires permanent overflow (100104178 / 59 Points).
- Lavabo GELCOAT. **RICHIÈDE TOP IN.**
- Richiede valvola (100104178 / 59 punti).
- Раковина GELCOAT. **НУЖДАЕТСЯ В СТОЛЕШНИЦЕ.**
- Требуется постоянный перелив (100104178 / 59 позиций).



- Optional black plate (250055710 / 143 points).
- Copripiletta nero opzionale (250055710 / 143 punti).
- Опционально черная накладка (250055710 / 143 пунктов).

MEASURES	FINISHES	SAP	POINTS
50x15x48 / 19 <sup>5/8</sup> x5 <sup>7/8</sup> x18 <sup>7/8</sup>	GELCOAT	100136309	632
70x15x48 / 27 <sup>1/2</sup> x5 <sup>7/8</sup> x18 <sup>7/8</sup>		100128501	736

## BASIN

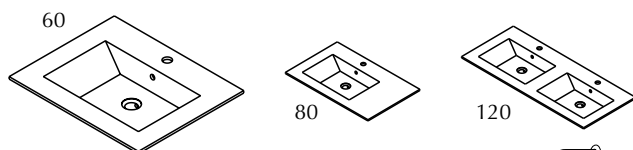

- GELCOAT basin with overflow.
- Requires for installation valve **SAP100200010, 72 P.**
- Lavabo GELCOAT con troppopieno.
- Richiede valvola **SAP100200010, 72 P.**
- Раковина GELCOAT с переливом.
- Требуется установка клапана SAP100200010, 72 P.

MEASURES	FINISHES	SAP	POINTS
60,5x14,1x49,2 / 23 <sup>7/8</sup> x5 <sup>1/2</sup> x19 <sup>3/8</sup>	GELCOAT	100160956	0560
80,5x14,1x49,2 / 31 <sup>3/4</sup> x5 <sup>1/2</sup> x19 <sup>3/8</sup>		100160957	0582
120,5x14,1x49,2 / 47 <sup>1/2</sup> x5 <sup>1/2</sup> x19 <sup>3/8</sup>		100171860	0981

## WORKTOP KRION STONE

DEPTH 49,2CM / 19<sup>3/8</sup>"

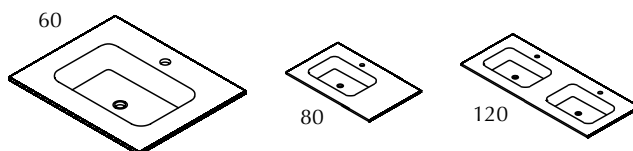

- Worktop KRION STONE with integrated basin.
- Requires for installation permanent valve SAP100036254, 68 P.
- Requires drainage SAP100036255, 103 P.
- Top in KRION STONE con lavabo integrato.
- Richiede valvola SAP100036254, 68 P.
- Richiede scarico SAP100036255, 103 P.
- Столешница KRION STONE со встроенной раковиной.
- Требуется установка постоянного клапана SAP100036254, 68 P.
- Требуется дренаж SAP100036255, 103 P.

MEASURES	FINISHES	SAP	POINTS
60,2x13x49,2 / 23 <sup>5/8</sup> x5 <sup>1/8</sup> x19 <sup>3/8</sup>	Krión STONE	100091017	617
80,2x13x49,2 / 31 <sup>1/2</sup> x5 <sup>1/8</sup> x19 <sup>3/8</sup>		100091018	660
120,2x13x49,2 / 47 <sup>3/8</sup> x5 <sup>1/8</sup> x19 <sup>3/8</sup>		100110448	1356

## CUSTOM BACK PANEL NADIR WOOD MIRROR

- Custom back panel NADIR wood mirror. **Compatible with SIDE / LAST accessory bar.**
- Specchio di legno NADIR. **Compatibile con la barra degli accessori SIDE / LAST.**
- Зеркало на деревянной панели. **Совместима с полкой для аксессуаров SIDE/LAST.**

ESP-RANGO	⇄							
	15-30 cm. 5 <sup>7/8</sup> -11 <sup>3/4</sup>	30,1-60 cm. 11 <sup>7/8</sup> -23 <sup>5/8</sup>	60,1-90 cm. 23 <sup>5/8</sup> -35 <sup>3/8</sup>	90,1-120 cm. 35 <sup>1/2</sup> -47 <sup>1/4</sup>	120,1-150 cm. 47 <sup>1/4</sup> -59	150,1-180 cm. 59 <sup>1/8</sup> -70 <sup>7/8</sup>	180,1-210 cm. 70 <sup>7/8</sup> -82 <sup>5/8</sup>	
⇄	15-30 cm. 5 <sup>7/8</sup> -11 <sup>3/4</sup>	SAP 700028107 180 P.	SAP 700028118 199 P.	SAP 700028128 217 P.	SAP 700028129 260 P.	SAP 700028130 284 P.	SAP 700028131 323 P.	SAP 700028132 361 P.
	30,1-60 cm. 11 <sup>7/8</sup> -23 <sup>5/8</sup>	SAP 700028133 199 P.	SAP 700028134 237 P.	SAP 700028108 283 P.	SAP 700028109 348 P.	SAP 700028110 393 P.	SAP 700028111 444 P.	SAP 700028112 495 P.
	60,1-90 cm. 23 <sup>5/8</sup> -35 <sup>3/8</sup>	SAP 700028113 217 P.	SAP 700028114 283 P.	SAP 700028115 344 P.	SAP 700028116 420 P.	SAP 700028117 490 P.	SAP 700028119 578 P.	SAP 700028120 650 P.
	90,1-120 cm. 35 <sup>1/2</sup> -47 <sup>1/4</sup>	SAP 700028121 238 P.	SAP 700028122 327 P.	SAP 700028123 404 P.	SAP 700028124 500 P.	SAP 700028125 603 P.	SAP 700028126 786 P.	SAP 700028127 883 P.



The interpretation made in inches for the dimensions of the different items shown in the price list has been rounded to 1/8, however for a more accurate measurement please use millimetres or centimetres.

## Last

<b>EXTERIOR FINISHES</b> FINITURE ESTERNE ОТДЕЛКА ДЛЯ НАРУЖНОГО ИСПОЛЬЗОВАНИЯ	<input checked="" type="checkbox"/> Laminate Laminato ЛАМИНАТ	<input checked="" type="checkbox"/> Matt lacquer Laccato opaco МАТОВЫЙ ЛАК	<input checked="" type="checkbox"/> Wood veneer Legno ДЕРЕВО
	<input type="checkbox"/> HPL Stratificato СЛОИСТАЯ	<input checked="" type="checkbox"/> Gloss lacquer Laccato lucido ГЛЯНЦЕВЫЙ ЛАК	<input type="checkbox"/> Aluminium, Metal finish Alluminio, finitura Metal Алюминий, отделка Metal
<b>INTERIOR FINISHES</b> FINITURE INTERNE ОТДЕЛКА ДЛЯ ВНУТРЕННЕГО ИСПОЛЬЗОВАНИЯ	<input type="checkbox"/> Laminate Laminato ЛАМИНАТ	<input type="checkbox"/> Wood veneer Legno ДЕРЕВО	<input checked="" type="checkbox"/> Aluminium+laminated base Alluminio + base in laminato Алюминий + основа из ламината
	<input checked="" type="checkbox"/> Front handle Maniglia frontale a vista Декоративная передняя ручка	<input type="checkbox"/> Integrated metal handle Maniglia metallica integrata Встроенная металлическая ручка	<input checked="" type="checkbox"/> Integrated mechanized h. Maniglia integrata ricavata sul bordo Встроенная ручка по краю
<b>HANDLES</b> MANIGLIE РУЧКИ	<input type="checkbox"/> Push handle Maniglia Push РУЧКИ Push		
<b>TYPE OF UNITS</b> TIPI DI MODULI ТИПЫ МОДУЛЕЙ	<input checked="" type="checkbox"/> Compact Compatto Компактная	<input checked="" type="checkbox"/> Modular Modulare Модульная	
<b>POSITION</b> POSIZIONE ПОЗИЦИЯ	<input checked="" type="checkbox"/> Wall-mounted Sospeso Подвесная	<input checked="" type="checkbox"/> Floor-mounted A terra Напольная	
<b>MEASURES (CM)</b> DIMENSIONI РАЗМЕРЫ	60 / 80 / 90 / 100 / 120 23 <sup>5/8</sup> / 31 <sup>1/2</sup> / 35 <sup>3/8</sup> / 39 <sup>3/8</sup> / 47 <sup>1/4</sup>	26 / 52 / 78 10 <sup>1/4</sup> / 20 <sup>1/2</sup> / 30 <sup>3/4</sup>	48 18 <sup>7/8</sup>
<b>WORKTOP &amp; BASIN OPTIONS</b> OPZIONI TOP E LAVABI ВАРИАНТЫ СТОЛЕШНИЦ И УМЫВАЛЬНЫХ РАКОВИН	<input type="checkbox"/> Bath serie's worktop / basin Lavabo / top della serie Серийная умывальная раковина / столешница	<input checked="" type="checkbox"/> Standard worktops Top standard Стандартные столешницы	<input checked="" type="checkbox"/> Worktop + integrated basin Encimera + lavabo integrato Столешница + встроенная умывальная раковина
	<input checked="" type="checkbox"/> Over-mounted basin Lavabo da appoggio Настольная умывальная раковина	<input checked="" type="checkbox"/> Under-mounted basin Lavabo sottopiano Умывальная раковина, встраиваемая в столешницу снизу	<input checked="" type="checkbox"/> Double basin as option Opzione doppia vasca Вариант с двойной чашей
<b>WORKTOP FINISHES</b> FINITURE TOP ОТДЕЛКА СТОЛЕШНИЦ	<input checked="" type="checkbox"/> Krion® worktop Top in KRION® Столешница KRION®	<input type="checkbox"/> Gel Coat worktop Top in Gel Coat Столешница с покрытием гелькоут	<input checked="" type="checkbox"/> Natural Stone worktop Top in pietra naturale Столешница из натурального камня.
	<input type="checkbox"/> Glass worktop Top in vetro Столешница из стекла	<input type="checkbox"/> Bath furniture finish worktop Top con la finitura del mobile Столешница с той же отделкой, что и консоль/тумба	
<b>BASIN FINISHES</b> FINITURE LAVABI ОТДЕЛКА УМЫВАЛЬНЫХ РАКОВИН	<input checked="" type="checkbox"/> Krion® basin Lavabo in Krion® Умывальная раковина из Krion®	<input checked="" type="checkbox"/> Gel Coat basin Lavabo Gelcoat Раковина Gelcoat	<input checked="" type="checkbox"/> Ceramic basin Lavabo in ceramica Керамическая умывальная раковина
	<input checked="" type="checkbox"/> Natural Stone basin Lavabo in pietra naturale Умывальная раковина из натурального камня.		
<b>ACCESSORIES</b> ACCESSORI АКСЕССУАРЫ	<input type="checkbox"/> Mirror Specchio Зеркало	<input checked="" type="checkbox"/> Wall-mounted module Modulo sospeso Подвесной модуль	<input checked="" type="checkbox"/> Tall cabinet Modulo colonna Высокий шкаф
	<input type="checkbox"/> Upper unit Modulo alto Верхний модуль	<input type="checkbox"/> Organizer Organizzatore Органайзер	<input checked="" type="checkbox"/> Shelves Mensola Полка
			<input type="checkbox"/> Accessories Accessori Аксессуары

# *last*



A bathroom vanity that plays with dimensions, providing dynamism thanks to the arrangement of its different modules, which allow us an endless number of configurations.

Last è un mobile bagno di cui varia la dimensione; punta a un effetto dinamico grazie alla flessibilità dei moduli, che ci permettono un numero infinito di configurazioni.

Last - это мебель для ванной комнаты, которая играет с глубинами и размерами, обеспечивая динамичное использование, благодаря расположению различных модулей, которые позволяют нам бесконечное количество конфигураций.



+info p383

10694 Points  
LAST blanco snow mate

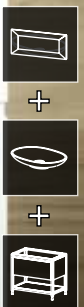

+info p.383

6868 Points  
LAST blanco snow mate

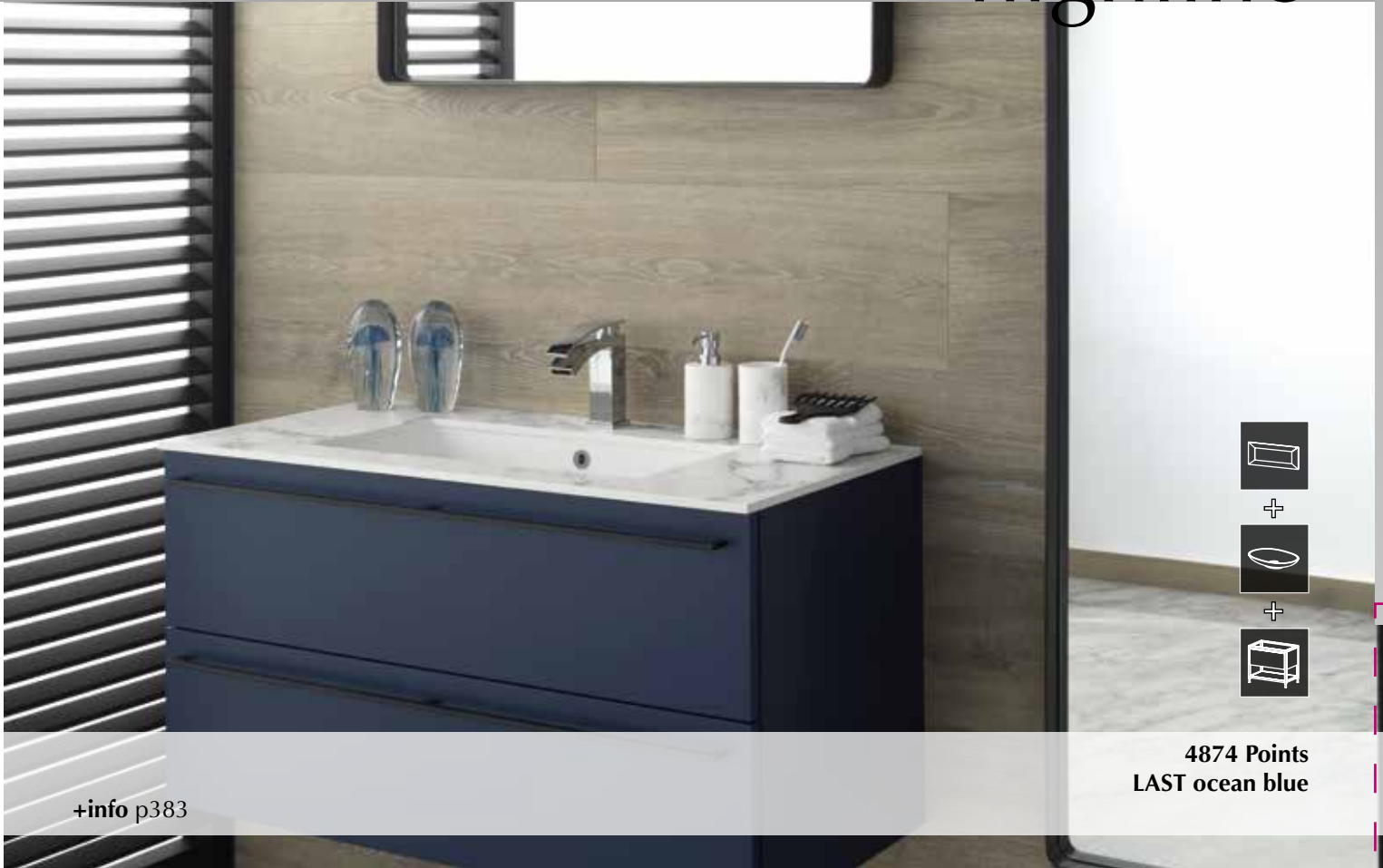

**4874 Points**  
**LAST ocean blue**

+info p383



**SET 0477**    **1976 Points**  
**LAST Wind**  
**100254958**

+info p.383



## FINISHES

GLOSS LACQUER / MATT LACQUER LACCATO LUCIDO / LACCATO OPACO ГЛЯНЦЕВЫЙ ЛАК / МАТОВЫЙ ЛАК



Ónix



Cromo

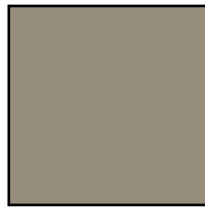

Férreo



Tórtola



Sílice



Bórax

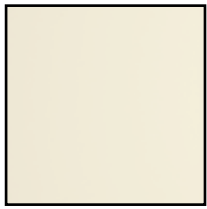

Cuarcita



Pizarra



Grafito

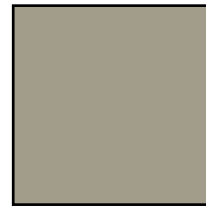

Plomo

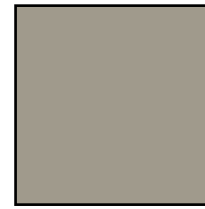

Limo

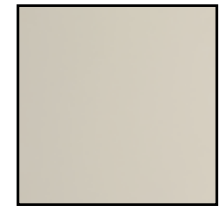

Pérgamon

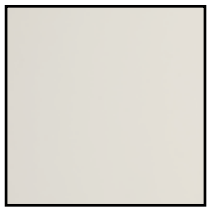

Alabastro

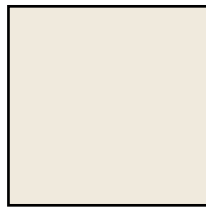

Porcelana



Negro Emotions



Ocean Blue



Azul Navy



Bottle

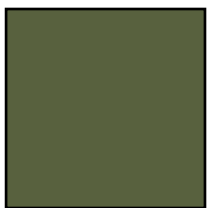

Orégano



Cúrcuma



Safrán



Curry



Blanco Snow



Blanco Emotions

WOOD

LEGNO

ДЕРЕВО



Roble Noche



Roble Cobre

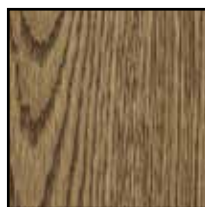

Roble Bronce



Roble Sil



Roble Alba

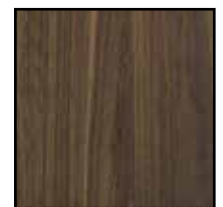

Roble torrefacto



Nogal seda

## FINISHES

LAMINATE

LAMINATO

ЛАМИНАТ

R1



Eucalyptus Blond



Eucalyptus Gray



Eucalyptus Candy



Eucalyptus Smutty



Etimoe Ice



Etimoe Land

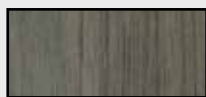

Etimoe Night

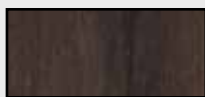

Nogal Moon



Clear

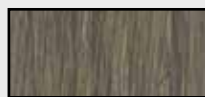

Coffee



Crust

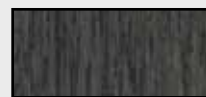

Burn

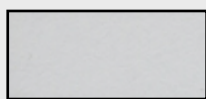

Niebla

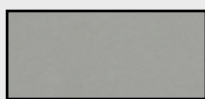

Zinc

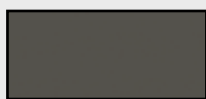

Cool

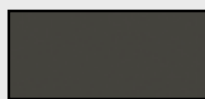

Graffiti

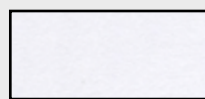

Blanco Núblol

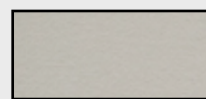

Bisón

R3

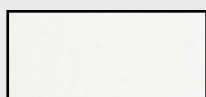

Blanco Snow

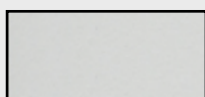

Gris Hook Mate

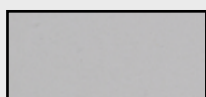

Cement Mate



Storm Mate

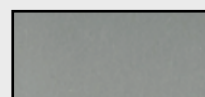

Wind Mate

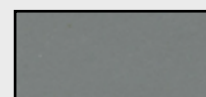

Marea Mate

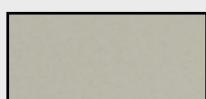

Mouse Mate

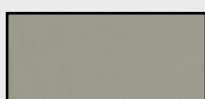

Topo Mate

R4

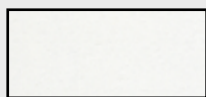

Blanco Sal

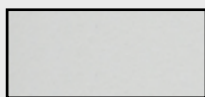

Gris Hook Brillo

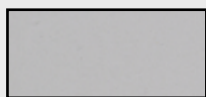

Cement Brillo

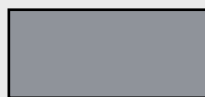

Storm Brillo

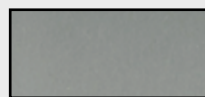

Wind Brillo

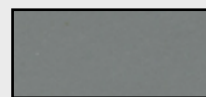

Marea Brillo

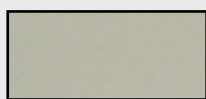

Mouse Brillo

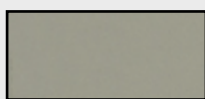

Topo Brillo

WORKTOPS

TOP

СТОЛЕШНИЦЫ

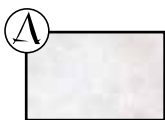

Arctic White



Via Lactea



Mármol Carrara



M. Blanco Ibiza

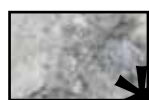

Granito Portobello



Arabescato Orobico



G. Negro Tanzania M.



Granito Len

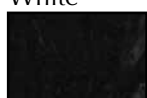

Barocco Vintage



Cheyenne Vintage

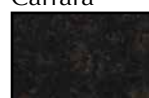

Amarula Vintage

\* Maximum length recommended 120 cm. / 47<sup>1</sup>/<sub>4</sub>"

\* Lunghezza massima raccomandata 120 cm. / 47<sup>1</sup>/<sub>4</sub>"

\* Рекомендуемая максимальная длина — 120 см / 47<sup>1</sup>/<sub>4</sub>"

HANDLE A (PUSH)	OPTION
	A

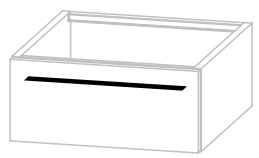
HANDLE M	OPTION	MEASURES	MODULE	HANDLE POSITION
	M	37,2 cm. / 14 <sup>5/8</sup>	45 cm. / 17 <sup>3/4</sup>	
		52,7 cm. / 20 <sup>3/4</sup>	60 cm. / 23 <sup>5/8</sup>	
		72,7 cm. / 28 <sup>5/8</sup>	80 cm. / 31 <sup>1/2</sup>	
		82,7 cm. / 32 <sup>1/2</sup>	90 cm. / 35 <sup>3/8</sup>	
		92,7 cm. / 36 <sup>1/2</sup>	100 cm. / 39 <sup>3/8</sup>	
		112,7 cm. / 44 <sup>3/8</sup>	120 cm. / 47 <sup>1/4</sup>	

HANDLE L (UÑERO)	OPTION
	L

HANDLE V (UÑERO)	OPTION
	V

HANDLE T	OPTION	HANDLE POSITION
	T	



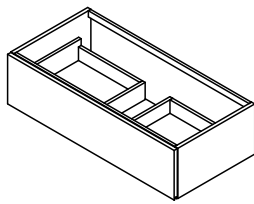

- Wash basin unit. For over mounted basin.
- Basi portlavabo. Per lavabo in appoggio.
- Тумбочка под умывальник. Для накладной раковины

MEASURES	FINISHES	HANDLE	BASIN	SAP	POINTS
60x26x48 / 23 <sup>5/8</sup> x10 <sup>1/4</sup> x18 <sup>7/8</sup>	Gloss lacquer	A/L/M/V	CENTERED	700026342	890
	Matt lacquer			700026341	787
	Wood			700026343	1004
	Laminate R1			700030892	633
	Laminate R3			700026340	661
	Laminate R4			700031002	718
80x26x48 / 31 <sup>1/2</sup> x10 <sup>1/4</sup> x18 <sup>7/8</sup>	Gloss lacquer	A/L/M/V	CENTERED / SX	700026346	972
	Matt lacquer			700026345	854
	Wood			700026347	1091
	Laminate R1			700030893	676
	Laminate R3			700026344	710
	Laminate R4			700031003	778
90x26x48 / 35 <sup>3/8</sup> x10 <sup>1/4</sup> x18 <sup>7/8</sup>	Gloss lacquer	A/L/M/V	CENTERED	700026350	1003
	Matt lacquer			700026349	878
	Wood			700026351	1118
	Laminate R1			700030894	688
	Laminate R3			700026348	725
	Laminate R4			700031004	799
100x26x48 / 39 <sup>3/8</sup> x10 <sup>1/4</sup> x18 <sup>7/8</sup>	Gloss lacquer	L/M/V	CENTERED	700026354	1049
	Matt lacquer			700026353	917
	Wood			700026355	1161
	Laminate R1			700030895	715
	Laminate R3			700026352	754
	Laminate R4			700031005	835
120x26x48 / 47 <sup>1/4</sup> x10 <sup>1/4</sup> x18 <sup>7/8</sup>	Gloss lacquer	L/M/V	CENTERED / DX / SX	700026358	1111
	Matt lacquer			700026357	972
	Wood			700026359	1243
	Laminate R1			700030896	760
	Laminate R3			700026356	806
	Laminate R4			700031006	898

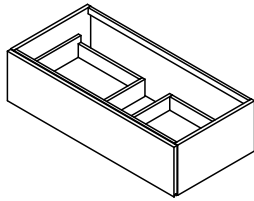

-Wash basin unit. For over mounted basin.

-Basi portalavabo. Per lavabo in appoggio.

-Тумбочка под умывальник. Для накладной раковины

MEASURES (x x x)	FINISHES	HANDLE	BASIN	SAP	POINTS
60-80x26x48 23 <sup>5</sup> / <sub>8</sub> -31 <sup>1</sup> / <sub>2</sub> x10 <sup>1</sup> / <sub>4</sub> x18 <sup>7</sup> / <sub>8</sub>	Gloss lacquer	LV	CENTERED	700026438	972
	Matt lacquer			700026437	854
	Wood			700026439	1091
	Laminate R1			700030897	676
	Laminate R3			700026436	710
	Laminate R4			700031007	778
>80-100x26x48 >31 <sup>1</sup> / <sub>2</sub> -39 <sup>3</sup> / <sub>8</sub> x10 <sup>1</sup> / <sub>4</sub> x18 <sup>7</sup> / <sub>8</sub>	Gloss lacquer	LV	CENTERED	700026442	1049
	Matt lacquer			700026441	917
	Wood			700026443	1161
	Laminate R1			700030898	715
	Laminate R3			700026440	754
	Laminate R4			700031008	835
>100-120x26x48 39 <sup>3</sup> / <sub>8</sub> -47 <sup>1</sup> / <sub>4</sub> x10 <sup>1</sup> / <sub>4</sub> x18 <sup>7</sup> / <sub>8</sub>	Gloss lacquer	LV	CENTERED	700026446	1111
	Matt lacquer			700026445	972
	Wood			700026447	1243
	Laminate R1			700030899	760
	Laminate R3			700026444	806
	Laminate R4			700031009	898

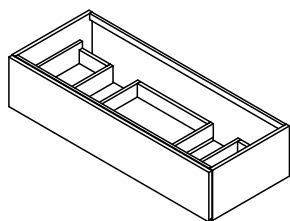

- Wash basin unit. For over mounted basin.
- Basi portalavabo. Per lavabo in appoggio.
- Тумбочка под умывальник. Для накладной раковины

MEASURES 	FINISHES	HANDLE	BASIN	SAP	POINTS
120x26x48 / 47 <sup>1</sup> / <sub>4</sub> x10 <sup>1</sup> / <sub>4</sub> x18 <sup>7</sup> / <sub>8</sub>	Gloss lacquer			700026362	1150
	Matt lacquer			700026361	1010
	Wood	L/M/V	DS	700026363	1286
	Laminate R1			700030910	798
	Laminate R3			700026360	844
	Laminate R4			700031010	936

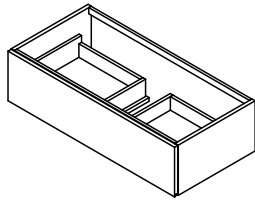

- Wash basin unit. For sotto basin.
- Basi portalavabo. Per lavabo sottotop.
- Тумбочка под умывальник. Для раковины Sotto



MEASURES (x)x(x)x(x)	FINISHES	HANDLE	BASIN	SAP	POINTS
60x26x48 / 23 <sup>5</sup> / <sub>8</sub> x10 <sup>1</sup> / <sub>4</sub> x18 <sup>7</sup> / <sub>8</sub>	Gloss lacquer	A/L/M/V	CENTERED	700026366	927
	Matt lacquer			700026365	824
	Wood			700026367	1046
	Laminate R1			700030911	670
	Laminate R3			700026364	698
	Laminate R4			700031011	755
80x26x48 / 31 <sup>1</sup> / <sub>2</sub> x10 <sup>1</sup> / <sub>4</sub> x18 <sup>7</sup> / <sub>8</sub>	Gloss lacquer	A/L/M/V	CENTERED / SX	700026370	1007
	Matt lacquer			700026369	890
	Wood			700026371	1131
	Laminate R1			700030912	712
	Laminate R3			700026368	745
	Laminate R4			700031012	814
90x26x48 / 35 <sup>3</sup> / <sub>8</sub> x10 <sup>1</sup> / <sub>4</sub> x18 <sup>7</sup> / <sub>8</sub>	Gloss lacquer	A/L/M/V	CENTERED	700026374	1039
	Matt lacquer			700026373	914
	Wood			700026375	1158
	Laminate R1			700030913	724
	Laminate R3			700026372	761
	Laminate R4			700031013	835
100x26x48 / 39 <sup>3</sup> / <sub>8</sub> x10 <sup>1</sup> / <sub>4</sub> x18 <sup>7</sup> / <sub>8</sub>	Gloss lacquer	L/M/V	CENTERED	700026378	1085
	Matt lacquer			700026377	952
	Wood			700026379	1202
	Laminate R1			700030914	750
	Laminate R3			700026376	790
	Laminate R4			700031014	870
120x26x48 / 47 <sup>1</sup> / <sub>4</sub> x10 <sup>1</sup> / <sub>4</sub> x18 <sup>7</sup> / <sub>8</sub>	Gloss lacquer	L/M/V	CENTERED / DX / SX	700026382	1147
	Matt lacquer			700026381	1008
	Wood			700026383	1283
	Laminate R1			700030915	796
	Laminate R3			700026380	841
	Laminate R4			700031015	934

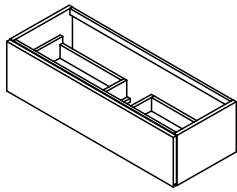

-Wash basin unit. For sotto basin.

-Basi portalavabo. Per lavabo sottotop.

-Тумбочка под умывальник. Для раковины Sotto



MEASURES 	FINISHES	HANDLE	BASIN	SAP	POINTS
60x26x35 / 23 <sup>5/8</sup> x10 <sup>1/4</sup> x13 <sup>3/4</sup>	Gloss lacquer	A/L/M/V	CENTERED	700031122	895
	Matt lacquer			700031123	782
	Wood			700031127	994
	Laminate R1			700031125	628
	Laminate R3			700031124	650
	Laminate R4			700031126	694
80x26x35 / 31 <sup>1/2</sup> x10 <sup>1/4</sup> x13 <sup>3/4</sup>	Gloss lacquer	A/L/M/V	CENTERED / SX	700031128	971
	Matt lacquer			700031129	844
	Wood			700031133	1064
	Laminate R1			700031131	666
	Laminate R3			700031130	692
	Laminate R4			700031132	746
90x26x35 / 35 <sup>3/8</sup> x10 <sup>1/4</sup> x13 <sup>3/4</sup>	Gloss lacquer	A/L/M/V	CENTERED	700031134	1000
	Matt lacquer			700031135	865
	Wood			700031139	1089
	Laminate R1			700031137	675
	Laminate R3			700031136	704
	Laminate R4			700031138	763
100x26x35 / 39 <sup>3/8</sup> x10 <sup>1/4</sup> x13 <sup>3/4</sup>	Gloss lacquer	L/M/V	CENTERED	700031110	1045
	Matt lacquer			700031111	903
	Wood			700031115	1131
	Laminate R1			700031113	700
	Laminate R3			700031112	731
	Laminate R4			700031114	795
120x26x35 / 47 <sup>1/4</sup> x10 <sup>1/4</sup> x13 <sup>3/4</sup>	Gloss lacquer	L/M/V	CENTERED / DX / SX	700031116	1109
	Matt lacquer			700031117	960
	Wood			700031121	1215
	Laminate R1			700031119	746
	Laminate R3			700031118	783
	Laminate R4			700031120	856

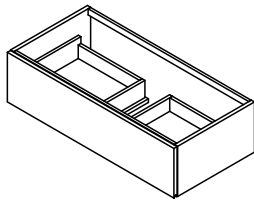

- Wash basin unit. For sotto basin.
- Basi portalavabo. Per lavabo sottotop.
- Тумбочка под умывальник. Для раковины Sotto



MEASURES (x x x)	FINISHES	HANDLE	BASIN	SAP	POINTS
60-80x26x48 23 <sup>5</sup> / <sub>8</sub> -31 <sup>1</sup> / <sub>2</sub> x10 <sup>1</sup> / <sub>4</sub> x18 <sup>7</sup> / <sub>8</sub>	Gloss lacquer	L/V	CENTERED	700026450	1007
	Matt lacquer			700026449	890
	Wood			700026451	1131
	Laminate R1			700030916	712
	Laminate R3			700026448	745
	Laminate R4			700031016	814
>80-100x26x48 >31 <sup>1</sup> / <sub>2</sub> -39 <sup>3</sup> / <sub>8</sub> x10 <sup>1</sup> / <sub>4</sub> x18 <sup>7</sup> / <sub>8</sub>	Gloss lacquer	L/V	CENTERED	700026454	1085
	Matt lacquer			700026453	952
	Wood			700026455	1202
	Laminate R1			700030917	750
	Laminate R3			700026452	790
	Laminate R4			700031017	870
>100-120x26x48 39 <sup>3</sup> / <sub>8</sub> -47 <sup>1</sup> / <sub>4</sub> x10 <sup>1</sup> / <sub>4</sub> x18 <sup>7</sup> / <sub>8</sub>	Gloss lacquer	L/V	CENTERED	700026458	1147
	Matt lacquer			700026457	1008
	Wood			700026459	1283
	Laminate R1			700030918	796
	Laminate R3			700026456	841
	Laminate R4			700031018	934

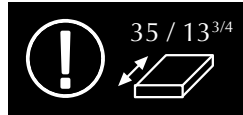
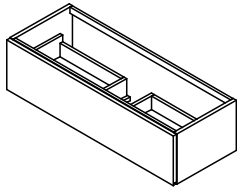

-Wash basin unit. For sotto basin.

-Basi portalavabo. Per lavabo sottotop.

-Тумбочка под умывальник. Для раковины Sotto



MEASURES (x x x)	FINISHES	HANDLE	BASIN	SAP	POINTS
60-80x26x35 23 <sup>5/8</sup> -31 <sup>1/2</sup> x10 <sup>1/4</sup> x13 <sup>3/4</sup>	Gloss lacquer	L/V	CENTERED	700031188	971
	Matt lacquer			700031189	844
	Wood			700031193	1064
	Laminate R1			700031191	666
	Laminate R3			700031190	692
	Laminate R4			700031192	746
>80-100x26x35 >31 <sup>1/2</sup> -39 <sup>3/8</sup> x10 <sup>1/4</sup> x13 <sup>3/4</sup>	Gloss lacquer	L/V	CENTERED	700031194	1045
	Matt lacquer			700031195	903
	Wood			700031199	1131
	Laminate R1			700031197	700
	Laminate R3			700031196	731
	Laminate R4			700031198	795
>100-120x26x35 39 <sup>3/8</sup> -47 <sup>1/4</sup> x10 <sup>1/4</sup> x13 <sup>3/4</sup>	Gloss lacquer	L/V	CENTERED	700031182	1109
	Matt lacquer			700031183	960
	Wood			700031187	1215
	Laminate R1			700031185	746
	Laminate R3			700031184	783
	Laminate R4			700031186	856

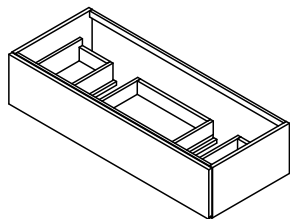

- Wash basin unit. For sotto basin.
- Basi portalavabo. Per lavabo sottotop.
- Тумбочка под умывальник. Для раковины Sotto



MEASURES (x x x)	FINISHES	HANDLE	BASIN	SAP	POINTS
120x26x48 / 47 <sup>1</sup> / <sub>4</sub> x10 <sup>1</sup> / <sub>4</sub> x18 <sup>7</sup> / <sub>8</sub>	Gloss lacquer			700026386	1204
	Matt lacquer			700026385	1065
	Wood	L/M/V	DS	700026387	1348
	Laminate R1			700030919	853
	Laminate R3			700026384	899
	Laminate R4			700031019	991



WASH BASIN UNIT BPS-3004

DEPTH 35 CM / 13<sup>3/4</sup>"

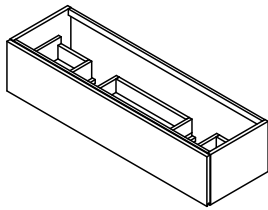

-Wash basin unit. For sotto basin.

-Basi portalavabo. Per lavabo sottotop.

-Тумбочка под умывальник. Для раковины Sotto



MEASURES 	FINISHES	HANDLE	BASIN	SAP	POINTS
120x26x35 / 47 <sup>1/4</sup> x10 <sup>1/4</sup> x13 <sup>3/4</sup>	Gloss lacquer			700031140	1147
	Matt lacquer			700031141	998
	Wood	L/M/V	DS	700031145	1257
	Laminate R1			700031143	784
	Laminate R3			700031142	820
	Laminate R4			700031144	894

last

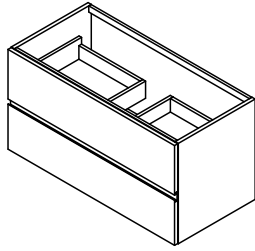

- Wash basin unit.
- Basi portalavabo.
- Тумбочка под умывальник.



MEASURES (x x x)	FINISHES	HANDLE	BASIN	SAP	POINTS
60x52x48 / 23 <sup>5</sup> / <sub>8</sub> x20 <sup>1</sup> / <sub>2</sub> x18 <sup>7</sup> / <sub>8</sub>	Gloss lacquer	A/L/M/V	CENTERED	700026390	1426
	Matt lacquer			700026389	1231
	Wood			700026391	1603
	Laminate R1			700030920	943
	Laminate R3			700026388	988
	Laminate R4			700031020	1080
80x52x48 / 31 <sup>1</sup> / <sub>2</sub> x20 <sup>1</sup> / <sub>2</sub> x18 <sup>7</sup> / <sub>8</sub>	Gloss lacquer	A/L/M/V	CENTERED / SX	700026394	1580
	Matt lacquer			700026393	1356
	Wood			700026395	1747
	Laminate R1			700030921	1017
	Laminate R3			700026392	1071
	Laminate R4			700031021	1180
90x52x48 / 35 <sup>3</sup> / <sub>8</sub> x20 <sup>1</sup> / <sub>2</sub> x18 <sup>7</sup> / <sub>8</sub>	Gloss lacquer	A/L/M/V	CENTERED	700026398	1643
	Matt lacquer			700026397	1404
	Wood			700026399	1801
	Laminate R1			700030922	1040
	Laminate R3			700026396	1098
	Laminate R4			700031022	1215
100x52x48 / 39 <sup>3</sup> / <sub>8</sub> x20 <sup>1</sup> / <sub>2</sub> x18 <sup>7</sup> / <sub>8</sub>	Gloss lacquer	L/M/V	CENTERED	700026402	1723
	Matt lacquer			700026401	1470
	Wood			700026403	1877
	Laminate R1			700030923	1080
	Laminate R3			700026400	1142
	Laminate R4			700031023	1267
120x52x48 / 47 <sup>1</sup> / <sub>4</sub> x20 <sup>1</sup> / <sub>2</sub> x18 <sup>7</sup> / <sub>8</sub>	Gloss lacquer	L/M/V	CENTERED / DX / SX	700026406	1833
	Matt lacquer			700026405	1566
	Wood			700026407	2027
	Laminate R1			700030924	1154
	Laminate R3			700026404	1224
	Laminate R4			700031024	1366

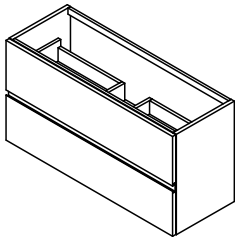

-Wash basin unit.  
-Basi portalavabo.  
-Тумбочка под умывальник.



MEASURES 	FINISHES	HANDLE	BASIN	SAP	POINTS
60x52x35 / 23 <sup>5/8</sup> x20 <sup>1/2</sup> x13 <sup>3/4</sup>	Gloss lacquer	A/L/M/V	CENTERED	700031158	1360
	Matt lacquer			700031159	1189
	Wood			700031163	1535
	Laminate R1			700031161	919
	Laminate R3			700031160	956
	Laminate R4			700031162	1030
80x52x35 / 31 <sup>1/2</sup> x20 <sup>1/2</sup> x13 <sup>3/4</sup>	Gloss lacquer	A/L/M/V	CENTERED / SX	700031164	1509
	Matt lacquer			700031165	1309
	Wood			700031169	1673
	Laminate R1			700031167	987
	Laminate R3			700031166	1031
	Laminate R4			700031168	1119
90x52x35 / 35 <sup>3/8</sup> x20 <sup>1/2</sup> x13 <sup>3/4</sup>	Gloss lacquer	A/L/M/V	CENTERED	700031170	1565
	Matt lacquer			700031171	1351
	Wood			700031175	1720
	Laminate R1			700031173	1004
	Laminate R3			700031172	1051
	Laminate R4			700031174	1146
100x52x35 / 39 <sup>3/8</sup> x20 <sup>1/2</sup> x13 <sup>3/4</sup>	Gloss lacquer	L/M/V	CENTERED	700031146	1644
	Matt lacquer			700031147	1415
	Wood			700031151	1794
	Laminate R1			700031149	1042
	Laminate R3			700031148	1093
	Laminate R4			700031150	1195
120x52x35 / 47 <sup>1/4</sup> x20 <sup>1/2</sup> x13 <sup>3/4</sup>	Gloss lacquer	L/M/V	CENTERED / DX / SX	700031152	1759
	Matt lacquer			700031153	1516
	Wood			700031157	1949
	Laminate R1			700031155	1120
	Laminate R3			700031154	1178
	Laminate R4			700031156	1295

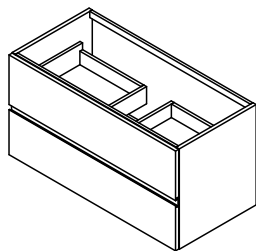

- Wash basin unit.
- Basi portalavabo.
- Тумбочка под умывальник.



MEASURES (x x x)	FINISHES	HANDLE	BASIN	SAP	POINTS
60-80x52x48 23 <sup>5</sup> / <sub>8</sub> -31 <sup>1</sup> / <sub>2</sub> x20 <sup>1</sup> / <sub>2</sub> x18 <sup>7</sup> / <sub>8</sub>	Gloss lacquer	L/V	CENTERED	700026462	1580
	Matt lacquer			700026461	1356
	Wood			700026463	1747
	Laminate R1			700030925	1017
	Laminate R3			700026460	1071
	Laminate R4			700031025	1180
>80-100x52x48 >31 <sup>1</sup> / <sub>2</sub> -39 <sup>3</sup> / <sub>8</sub> x20 <sup>1</sup> / <sub>2</sub> x18 <sup>7</sup> / <sub>8</sub>	Gloss lacquer	L/V	CENTERED	700026466	1723
	Matt lacquer			700026465	1470
	Wood			700026467	1877
	Laminate R1			700030926	1080
	Laminate R3			700026464	1142
	Laminate R4			700031026	1267
>100-120x52x48 39 <sup>3</sup> / <sub>8</sub> -47 <sup>1</sup> / <sub>4</sub> x20 <sup>1</sup> / <sub>2</sub> x18 <sup>7</sup> / <sub>8</sub>	Gloss lacquer	L/V	CENTERED	700026470	1833
	Matt lacquer			700026469	1566
	Wood			700026471	2027
	Laminate R1			700030927	1154
	Laminate R3			700026468	1224
	Laminate R4			700031027	1366

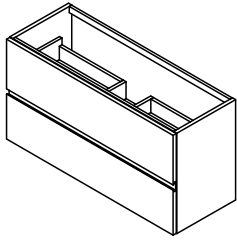

-Wash basin unit.  
-Basi portalavabo.  
-Тумбочка под умывальник.



MEASURES (x x x)	FINISHES	HANDLE	BASIN	SAP	POINTS
60-80x52x35 23 <sup>5/8</sup> -31 <sup>1/2</sup> x20 <sup>1/2</sup> x13 <sup>3/4</sup>	Gloss lacquer	L/V	CENTERED	700031206	1509
	Matt lacquer			700031207	1309
	Wood			700031211	1673
	Laminate R1			700031209	987
	Laminate R3			700031208	1031
	Laminate R4			700031210	1119
>80-100x52x35 >31 <sup>1/2</sup> -39 <sup>3/8</sup> x20 <sup>1/2</sup> x13 <sup>3/4</sup>	Gloss lacquer	L/V	CENTERED	700031212	1644
	Matt lacquer			700031213	1415
	Wood			700031217	1794
	Laminate R1			700031215	1042
	Laminate R3			700031214	1093
	Laminate R4			700031216	1195
>100-120x52x35 39 <sup>3/8</sup> -47 <sup>1/4</sup> x20 <sup>1/2</sup> x13 <sup>3/4</sup>	Gloss lacquer	L/V	CENTERED	700031200	1759
	Matt lacquer			700031201	1516
	Wood			700031205	1949
	Laminate R1			700031203	1120
	Laminate R3			700031202	1178
	Laminate R4			700031204	1295

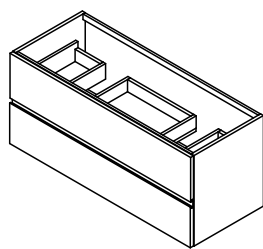

-Wash basin unit.  
 -Basi portalavabo.  
 -Тумбочка под умывальник.



MEASURES (WxDxH)	FINISHES	HANDLE	BASIN	SAP	POINTS
120x52x48 / 47 <sup>1/4</sup> x20 <sup>1/2</sup> x18 <sup>7/8</sup>	Gloss lacquer			700026410	1871
	Matt lacquer			700026409	1604
	Wood	L/M/V	DS	700026411	2070
	Laminate R1			700030928	1192
	Laminate R3			700026408	1262
	Laminate R4			700031028	1404

WASH BASIN UNIT BPS-3006

DEPTH 35 CM / 13<sup>3/4</sup>"

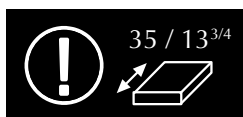
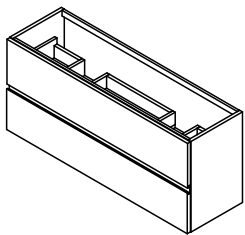

-Wash basin unit.  
-Basi portalavabo.  
-Тумбочка под умывальник.



MEASURES 	FINISHES	HANDLE	BASIN	SAP	POINTS
120x52x35 / 47 <sup>1/4</sup> x20 <sup>1/2</sup> x13 <sup>3/4</sup>	Gloss lacquer			700031176	1797
	Matt lacquer			700031177	1554
	Wood	L/M/V	DS	700031181	1992
	Laminate R1			700031179	1158
	Laminate R3			700031178	1215
	Laminate R4			700031180	1333

last

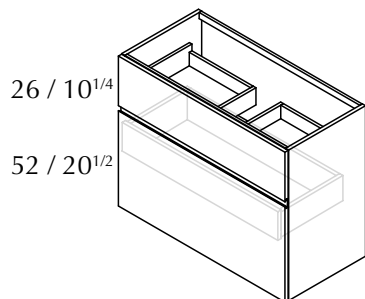

-Wash basin unit.  
-Basi portalavabo.  
-Тумбочка под умывальник.



MEASURES (x x x)	FINISHES	HANDLE	BASIN	SAP	POINTS
60x78x48 / 23 <sup>5</sup> / <sub>8</sub> x30 <sup>3</sup> / <sub>4</sub> x18 <sup>7</sup> / <sub>8</sub>	Gloss lacquer	A/L/M/V	CENTERED	700026414	1851
	Matt lacquer			700026413	1589
	Wood			700026415	2078
	Laminate R1			700030929	1217
	Laminate R3			700026412	1280
	Laminate R4			700031029	1408
80x78x48 / 31 <sup>1</sup> / <sub>2</sub> x30 <sup>3</sup> / <sub>4</sub> x18 <sup>7</sup> / <sub>8</sub>	Gloss lacquer	A/L/M/V	CENTERED / SX	700026418	2049
	Matt lacquer			700026417	1746
	Wood			700026419	2261
	Laminate R1			700030930	1308
	Laminate R3			700026416	1381
	Laminate R4			700031030	1530
90x78x48 / 35 <sup>3</sup> / <sub>8</sub> x30 <sup>3</sup> / <sub>4</sub> x18 <sup>7</sup> / <sub>8</sub>	Gloss lacquer	A/L/M/V	CENTERED	700026422	2135
	Matt lacquer			700026421	1811
	Wood			700026423	2336
	Laminate R1			700030931	1340
	Laminate R3			700026420	1418
	Laminate R4			700031031	1578
100x78x48 / 39 <sup>3</sup> / <sub>8</sub> x30 <sup>3</sup> / <sub>4</sub> x18 <sup>7</sup> / <sub>8</sub>	Gloss lacquer	L/M/V	CENTERED	700026426	2235
	Matt lacquer			700026425	1891
	Wood			700026427	2429
	Laminate R1			700030932	1386
	Laminate R3			700026424	1470
	Laminate R4			700031032	1640
120x78x48 / 47 <sup>1</sup> / <sub>4</sub> x30 <sup>3</sup> / <sub>4</sub> x18 <sup>7</sup> / <sub>8</sub>	Gloss lacquer	L/M/V	CENTERED / DX / SX	700026430	2406
	Matt lacquer			700026429	2035
	Wood			700026431	2626
	Laminate R1			700030933	1470
	Laminate R3			700026428	1564
	Laminate R4			700031033	1756



## WASH BASIN UNIT BPS-2012

DEPTH 48 CM / 18<sup>7</sup>/<sub>8</sub>"

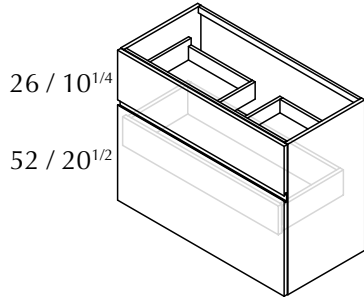

- Wash basin unit.
- Basi portalavabo.
- Тумбочка под умывальник.



MEASURES (x x x)	FINISHES	HANDLE	BASIN	SAP	POINTS
60-80x78x48 23 <sup>5</sup> / <sub>8</sub> -31 <sup>1</sup> / <sub>2</sub> x30 <sup>3</sup> / <sub>4</sub> x18 <sup>7</sup> / <sub>8</sub>	Gloss lacquer	L/V	CENTERED	700026474	2049
	Matt lacquer			700026473	1746
	Wood			700026475	2261
	Laminate R1			700030934	1308
	Laminate R3			700026472	1381
	Laminate R4			700031034	1530
>80-100x78x48 >31 <sup>1</sup> / <sub>2</sub> -39 <sup>3</sup> / <sub>8</sub> x30 <sup>3</sup> / <sub>4</sub> x18 <sup>7</sup> / <sub>8</sub>	Gloss lacquer	L/V	CENTERED	700026478	2235
	Matt lacquer			700026477	1891
	Wood			700026479	2429
	Laminate R1			700030935	1386
	Laminate R3			700026476	1470
	Laminate R4			700031035	1640
>100-120x78x48 39 <sup>3</sup> / <sub>8</sub> -47 <sup>1</sup> / <sub>4</sub> x30 <sup>3</sup> / <sub>4</sub> x18 <sup>7</sup> / <sub>8</sub>	Gloss lacquer	L/V	CENTERED	700026482	2406
	Matt lacquer			700026481	2035
	Wood			700026483	2626
	Laminate R1			700030936	1470
	Laminate R3			700026480	1564
	Laminate R4			700031036	1756

## WASH BASIN UNIT BPS-2008

DEPTH 48 CM / 18<sup>7</sup>/<sub>8</sub>"

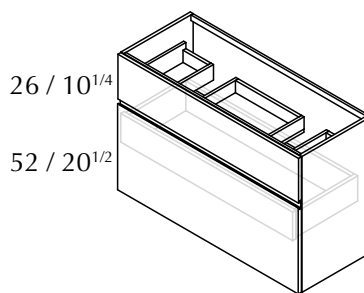

- Wash basin unit.
- Basi portalavabo.
- Тумбочка под умывальник.



MEASURES (x x x)	FINISHES	HANDLE	BASIN	SAP	POINTS
120x78x48 / 47 <sup>1</sup> / <sub>4</sub> x30 <sup>3</sup> / <sub>4</sub> x18 <sup>7</sup> / <sub>8</sub>	Gloss lacquer	L/M/V	DS	700026434	2444
	Matt lacquer			700026433	2073
	Wood			700026435	2669
	Laminate R1			700030937	1508
	Laminate R3			700026432	1602
	Laminate R4			700031037	1794

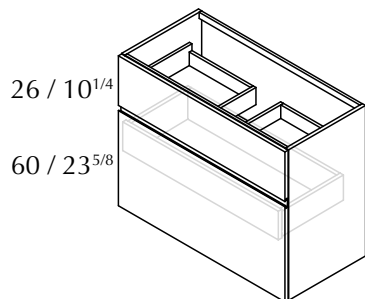

-Wash basin unit.  
-Basi portalavabo.  
-Тумбочка под умывальник.



MEASURES (x)x(x)x(x)	FINISHES	HANDLE	BASIN	SAP	POINTS
60x86x48 / 23 <sup>5</sup> / <sub>8</sub> x33 <sup>7</sup> / <sub>8</sub> x18 <sup>7</sup> / <sub>8</sub>	Gloss lacquer	L/M/V	CENTERED	700026858	1914
	Matt lacquer			700026859	1628
	Wood			700026861	2134
	Laminate R1			700030938	1226
	Laminate R3			700026860	1294
	Laminate R4			700031038	1433
80x86x48 / 31 <sup>1</sup> / <sub>2</sub> x33 <sup>7</sup> / <sub>8</sub> x18 <sup>7</sup> / <sub>8</sub>	Gloss lacquer	L/M/V	CENTERED / SX	700026862	2123
	Matt lacquer			700026863	1792
	Wood			700026865	2326
	Laminate R1			700030939	1318
	Laminate R3			700026864	1398
	Laminate R4			700031039	1559
90x86x48 / 35 <sup>3</sup> / <sub>8</sub> x33 <sup>7</sup> / <sub>8</sub> x18 <sup>7</sup> / <sub>8</sub>	Gloss lacquer	L/M/V	CENTERED	700026934	2214
	Matt lacquer			700026935	1860
	Wood			700026937	2405
	Laminate R1			700030940	1351
	Laminate R3			700026936	1435
	Laminate R4			700031040	1608
100x86x48 / 39 <sup>3</sup> / <sub>8</sub> x33 <sup>7</sup> / <sub>8</sub> x18 <sup>7</sup> / <sub>8</sub>	Gloss lacquer	L/M/V	CENTERED	700026850	2319
	Matt lacquer			700026851	1944
	Wood			700026853	2503
	Laminate R1			700030941	1398
	Laminate R3			700026852	1488
	Laminate R4			700031041	1672
120x86x48 / 47 <sup>1</sup> / <sub>4</sub> x33 <sup>7</sup> / <sub>8</sub> x18 <sup>7</sup> / <sub>8</sub>	Gloss lacquer	L/M/V	CENTERED / DX / SX	700026854	2500
	Matt lacquer			700026855	2093
	Wood			700026857	2707
	Laminate R1			700030942	1483
	Laminate R3			700026856	1584
	Laminate R4			700031042	1791

## WASH BASIN UNIT BPS-2029

DEPTH 48 CM / 18<sup>7</sup>/<sub>8</sub>"

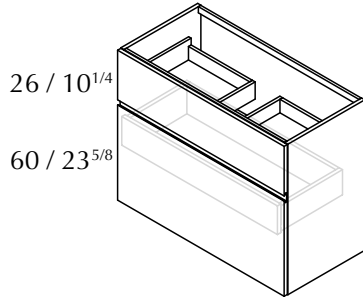

- Wash basin unit.
- Basi portalavabo.
- Тумбочка под умывальник.



MEASURES (x x x)	FINISHES	HANDLE	BASIN	SAP	POINTS
60-80x86x48 23 <sup>5</sup> / <sub>8</sub> -31 <sup>1</sup> / <sub>2</sub> x33 <sup>7</sup> / <sub>8</sub> x18 <sup>7</sup> / <sub>8</sub>	Gloss lacquer	L/V	CENTERED	700026878	2123
	Matt lacquer			700026879	1792
	Wood			700026881	2326
	Laminate R1			700030943	1318
	Laminate R3			700026880	1398
	Laminate R4			700031043	1559
>80-100x86x48 >31 <sup>1</sup> / <sub>2</sub> -39 <sup>3</sup> / <sub>8</sub> x33 <sup>7</sup> / <sub>8</sub> x18 <sup>7</sup> / <sub>8</sub>	Gloss lacquer	L/V	CENTERED	700026882	2319
	Matt lacquer			700026883	1944
	Wood			700026885	2503
	Laminate R1			700030944	1398
	Laminate R3			700026884	1488
	Laminate R4			700031044	1672
>100-120x86x48 39 <sup>3</sup> / <sub>8</sub> -47 <sup>1</sup> / <sub>4</sub> x33 <sup>7</sup> / <sub>8</sub> x18 <sup>7</sup> / <sub>8</sub>	Gloss lacquer	L/V	CENTERED	700026874	2500
	Matt lacquer			700026875	2093
	Wood			700026877	2707
	Laminate R1			700030945	1483
	Laminate R3			700026876	1584
	Laminate R4			700031045	1791

## WASH BASIN UNIT BPS-2028

DEPTH 48 CM / 18<sup>7</sup>/<sub>8</sub>"

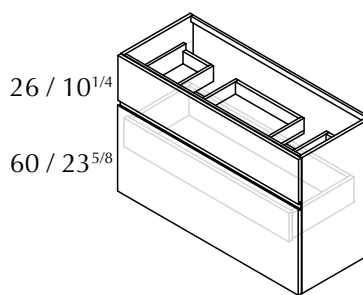

- Wash basin unit.
- Basi portalavabo.
- Тумбочка под умывальник.



MEASURES (x x x)	FINISHES	HANDLE	BASIN	SAP	POINTS
120x86x48 / 47 <sup>1</sup> / <sub>4</sub> x33 <sup>7</sup> / <sub>8</sub> x18 <sup>7</sup> / <sub>8</sub>	Gloss lacquer	L/M/V	DS	700026870	2538
	Matt lacquer			700026871	2131
	Wood			700026873	2750
	Laminate R1			700030946	1521
	Laminate R3			700026872	1622
	Laminate R4			700031046	1829

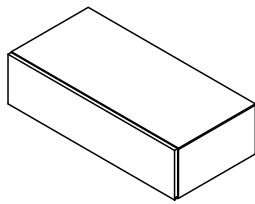

Wallmounted unit.

Modulo sospeso.

Тумба для ванной, монтируемая на стену.

MEASURES	(  )	FINISHES	HANDLE	SAP	POINTS
45x26x48 / 17 <sup>3/4</sup> x10 <sup>1/4</sup> x18 <sup>7/8</sup>		Gloss lacquer	A/L/M/V	700026486	897
		Matt lacquer		700026485	778
		Wood		700026487	1044
		Laminate R1		700030947	586
		Laminate R3		700026484	630
		Laminate R4		700031047	704
60x26x48 / 23 <sup>5/8</sup> x10 <sup>1/4</sup> x18 <sup>7/8</sup>		Gloss lacquer	A/L/M/V	700026490	982
		Matt lacquer		700026489	842
		Wood		700026491	1125
		Laminate R1		700030948	621
		Laminate R3		700026488	673
		Laminate R4		700031048	769
80x26x48 / 31 <sup>1/2</sup> x10 <sup>1/4</sup> x18 <sup>7/8</sup>		Gloss lacquer	A/L/M/V	700026494	1096
		Matt lacquer		700026493	931
		Wood		700026495	1247
		Laminate R1		700030949	677
		Laminate R3		700026492	741
		Laminate R4		700031049	865
90x26x48 / 35 <sup>3/8</sup> x10 <sup>1/4</sup> x18 <sup>7/8</sup>		Gloss lacquer	A/L/M/V	700026498	1147
		Matt lacquer		700026497	969
		Wood		700026499	1293
		Laminate R1		700030950	696
		Laminate R3		700026496	766
		Laminate R4		700031050	903
100x26x48 / 39 <sup>3/8</sup> x10 <sup>1/4</sup> x18 <sup>7/8</sup>		Gloss lacquer	L/M/V	700026502	1209
		Matt lacquer		700026501	1018
		Wood		700026503	1354
		Laminate R1		700030951	726
		Laminate R3		700026500	801
		Laminate R4		700031051	953
120x26x48 / 47 <sup>1/4</sup> x10 <sup>1/4</sup> x18 <sup>7/8</sup>		Gloss lacquer	L/M/V	700026506	1306
		Matt lacquer		700026505	1116
		Wood		700026507	1472
		Laminate R1		700030952	780
		Laminate R3		700026504	866
		Laminate R4		700031052	1046

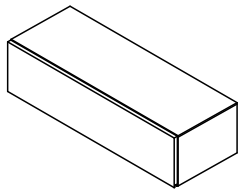
**FREESTANDING UNIT MS-3013**
**DEPTH 35 CM / 13<sup>3/4</sup>"**

Wallmounted unit.

Modulo sospeso.

Тумба для ванной, монтируемая на стену.

MEASURES	( x  x )	FINISHES	HANDLE	SAP	POINTS
45x26x35 / 17 <sup>3/4</sup> x10 <sup>1/4</sup> x13 <sup>3/4</sup>		Gloss lacquer	A/L/MV	700031230	867
		Matt lacquer		700031231	734
		Wood		700031235	988
		Laminate R1		700031233	567
		Laminate R3		700031232	592
		Laminate R4		700031234	662
60x26x35 / 23 <sup>5/8</sup> x10 <sup>1/4</sup> x13 <sup>3/4</sup>		Gloss lacquer	A/L/MV	700031236	945
		Matt lacquer		700031237	792
		Wood		700031241	1060
		Laminate R1		700031239	599
		Laminate R3		700031238	629
		Laminate R4		700031240	717
80x26x35 / 31 <sup>1/2</sup> x10 <sup>1/4</sup> x13 <sup>3/4</sup>		Gloss lacquer	A/L/MV	700031242	1053
		Matt lacquer		700031243	890
		Wood		700031247	1165
		Laminate R1		700031245	646
		Laminate R3		700031244	683
		Laminate R4		700031246	797
90x26x35 / 35 <sup>3/8</sup> x10 <sup>1/4</sup> x13 <sup>3/4</sup>		Gloss lacquer	A/L/MV	700031248	1097
		Matt lacquer		700031249	922
		Wood		700031253	1203
		Laminate R1		700031251	659
		Laminate R3		700031250	701
		Laminate R4		700031252	827
100x26x35 / 39 <sup>3/8</sup> x10 <sup>1/4</sup> x13 <sup>3/4</sup>		Gloss lacquer	L/MV	700031218	1151
		Matt lacquer		700031219	968
		Wood		700031223	1266
		Laminate R1		700031221	692
		Laminate R3		700031220	738
		Laminate R4		700031222	876
120x26x35 / 47 <sup>1/4</sup> x10 <sup>1/4</sup> x13 <sup>3/4</sup>		Gloss lacquer	L/MV	700031224	1240
		Matt lacquer		700031225	1041
		Wood		700031229	1376
		Laminate R1		700031227	744
		Laminate R3		700031226	797
		Laminate R4		700031228	960

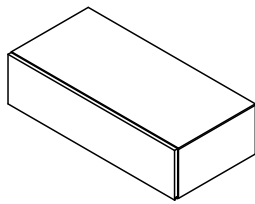

Wallmounted unit.

Modulo sospeso.

Тумба для ванной, монтируемая на стену.

MEASURES	(  )	FINISHES	HANDLE	SAP	POINTS
45-60x26x48 17 <sup>3</sup> / <sub>4</sub> -23 <sup>5</sup> / <sub>8</sub> x10 <sup>1</sup> / <sub>4</sub> x18 <sup>7</sup> / <sub>8</sub>		Gloss lacquer	L/V	700026558	982
		Matt lacquer		700026557	842
		Wood		700026559	1125
		Laminate R1		700030953	621
		Laminate R3		700026556	673
		Laminate R4		700031053	769
>60-80x26x48 >23 <sup>5</sup> / <sub>8</sub> -31 <sup>1</sup> / <sub>2</sub> x10 <sup>1</sup> / <sub>4</sub> x18 <sup>7</sup> / <sub>8</sub>		Gloss lacquer	L/V	700026562	1096
		Matt lacquer		700026561	931
		Wood		700026563	1247
		Laminate R1		700030954	677
		Laminate R3		700026560	741
		Laminate R4		700031054	865
>80-100x26x48 >31 <sup>1</sup> / <sub>2</sub> -39 <sup>3</sup> / <sub>8</sub> x10 <sup>1</sup> / <sub>4</sub> x18 <sup>7</sup> / <sub>8</sub>		Gloss lacquer	L/V	700026566	1209
		Matt lacquer		700026565	1018
		Wood		700026567	1354
		Laminate R1		700030955	726
		Laminate R3		700026564	801
		Laminate R4		700031055	953
>100-120x26x48 39 <sup>3</sup> / <sub>8</sub> -47 <sup>1</sup> / <sub>4</sub> x10 <sup>1</sup> / <sub>4</sub> x18 <sup>7</sup> / <sub>8</sub>		Gloss lacquer	L/V	700026570	1306
		Matt lacquer		700026569	1116
		Wood		700026571	1472
		Laminate R1		700030956	780
		Laminate R3		700026568	866
		Laminate R4		700031056	1046

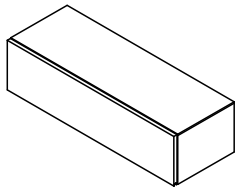

Wallmounted unit.

Modulo sospeso.

Тумба для ванной, монтируемая на стену.

MEASURES	( x  x )	FINISHES	HANDLE	SAP	POINTS
45-60x26x35 17 <sup>3/4</sup> -23 <sup>5/8</sup> x10 <sup>1/4</sup> x13 <sup>3/4</sup>		Gloss lacquer	L/V	700031296	945
		Matt lacquer		700031297	792
		Wood		700031301	1060
		Laminate R1		700031299	599
		Laminate R3		700031298	629
		Laminate R4		700031300	717
>60-80x26x35 >23 <sup>5/8</sup> -31 <sup>1/2</sup> x10 <sup>1/4</sup> x13 <sup>3/4</sup>		Gloss lacquer	L/V	700031302	1053
		Matt lacquer		700031303	890
		Wood		700031307	1165
		Laminate R1		700031305	646
		Laminate R3		700031304	683
		Laminate R4		700031306	797
>80-100x26x35 >31 <sup>1/2</sup> -39 <sup>3/8</sup> x10 <sup>1/4</sup> x13 <sup>3/4</sup>		Gloss lacquer	L/V	700031308	1151
		Matt lacquer		700031309	968
		Wood		700031313	1266
		Laminate R1		700031311	692
		Laminate R3		700031310	738
		Laminate R4		700031312	876
>100-120x26x35 39 <sup>3/8</sup> -47 <sup>1/4</sup> x10 <sup>1/4</sup> x13 <sup>3/4</sup>		Gloss lacquer	L/V	700031290	1240
		Matt lacquer		700031291	1041
		Wood		700031295	1376
		Laminate R1		700031293	744
		Laminate R3		700031292	797
		Laminate R4		700031294	960

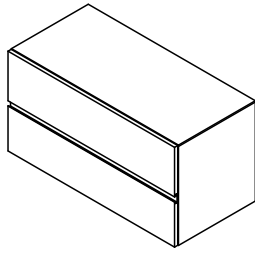

Wallmounted unit.

Modulo sospeso.

Тумба для ванной, монтируемая на стену.

MEASURES	(  )	FINISHES	HANDLE	SAP	POINTS
45x52x48 / 17 <sup>3/4</sup> x20 <sup>1/2</sup> x18 <sup>7/8</sup>		Gloss lacquer	A/L/M/V	700026510	1385
		Matt lacquer		700026509	1194
		Wood		700026511	1582
		Laminate R1		700030957	882
		Laminate R3		700026508	947
		Laminate R4		700031057	1066
60x52x48 / 23 <sup>5/8</sup> x20 <sup>1/2</sup> x18 <sup>7/8</sup>		Gloss lacquer	A/L/M/V	700026514	1523
		Matt lacquer		700026513	1300
		Wood		700026515	1710
		Laminate R1		700030958	939
		Laminate R3		700026512	1014
		Laminate R4		700031058	1165
80x52x48 / 31 <sup>1/2</sup> x20 <sup>1/2</sup> x18 <sup>7/8</sup>		Gloss lacquer	A/L/M/V	700026518	1714
		Matt lacquer		700026517	1454
		Wood		700026519	1901
		Laminate R1		700030959	1033
		Laminate R3		700026516	1122
		Laminate R4		700031059	1314
90x52x48 / 35 <sup>3/8</sup> x20 <sup>1/2</sup> x18 <sup>7/8</sup>		Gloss lacquer	A/L/M/V	700026522	1797
		Matt lacquer		700026521	1516
		Wood		700026523	1977
		Laminate R1		700030960	1064
		Laminate R3		700026520	1160
		Laminate R4		700031060	1372
100x52x48 / 39 <sup>3/8</sup> x20 <sup>1/2</sup> x18 <sup>7/8</sup>		Gloss lacquer	L/M/V	700026526	1895
		Matt lacquer		700026525	1594
		Wood		700026527	2070
		Laminate R1		700030961	1110
		Laminate R3		700026524	1212
		Laminate R4		700031061	1445
120x52x48 / 47 <sup>1/4</sup> x20 <sup>1/2</sup> x18 <sup>7/8</sup>		Gloss lacquer	L/M/V	700026530	2040
		Matt lacquer		700026529	1713
		Wood		700026531	2254
		Laminate R1		700030962	1194
		Laminate R3		700026528	1310
		Laminate R4		700031062	1585

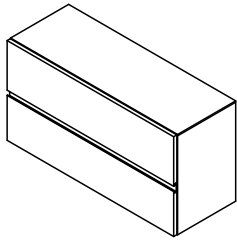

**FREESTANDING UNIT MS-3014**
**DEPTH 35 CM / 13<sup>3/4</sup>"**

Wallmounted unit.

Modulo sospeso.

Тумба для ванной, монтируемая на стену.

MEASURES	( x  x )	FINISHES	HANDLE	SAP	POINTS
45x52x35 / 17 <sup>3/4</sup> x20 <sup>1/2</sup> x13 <sup>3/4</sup>		Gloss lacquer	A/L/M/V	700031266	1298
		Matt lacquer		700031267	1118
		Wood		700031271	1493
		Laminate R1		700031269	856
		Laminate R3		700031268	910
		Laminate R4		700031270	1008
60x52x35 / 23 <sup>5/8</sup> x20 <sup>1/2</sup> x13 <sup>3/4</sup>		Gloss lacquer	A/L/M/V	700031272	1428
		Matt lacquer		700031273	1216
		Wood		700031277	1611
		Laminate R1		700031275	910
		Laminate R3		700031274	971
		Laminate R4		700031276	1097
80x52x35 / 31 <sup>1/2</sup> x20 <sup>1/2</sup> x13 <sup>3/4</sup>		Gloss lacquer	A/L/M/V	700031278	1612
		Matt lacquer		700031279	1360
		Wood		700031283	1784
		Laminate R1		700031281	994
		Laminate R3		700031280	1067
		Laminate R4		700031282	1229
90x52x35 / 35 <sup>3/8</sup> x20 <sup>1/2</sup> x13 <sup>3/4</sup>		Gloss lacquer	A/L/M/V	700031284	1685
		Matt lacquer		700031285	1412
		Wood		700031289	1848
		Laminate R1		700031287	1016
		Laminate R3		700031286	1094
		Laminate R4		700031288	1276
100x52x35 / 39 <sup>3/8</sup> x20 <sup>1/2</sup> x13 <sup>3/4</sup>		Gloss lacquer	L/M/V	700031254	1774
		Matt lacquer		700031255	1485
		Wood		700031259	1942
		Laminate R1		700031257	1064
		Laminate R3		700031256	1147
		Laminate R4		700031258	1347
120x52x35 / 47 <sup>1/4</sup> x20 <sup>1/2</sup> x13 <sup>3/4</sup>		Gloss lacquer	L/M/V	700031260	1914
		Matt lacquer		700031261	1632
		Wood		700031265	2121
		Laminate R1		700031263	1149
		Laminate R3		700031262	1243
		Laminate R4		700031264	1480

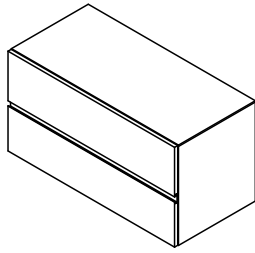

Wallmounted unit.

Modulo sospeso.

Тумба для ванной, монтируемая на стену.

MEASURES	(  )	FINISHES	HANDLE	SAP	POINTS
45-60x52x48 17 <sup>3</sup> / <sub>4</sub> -23 <sup>5</sup> / <sub>8</sub> x20 <sup>1</sup> / <sub>2</sub> x18 <sup>7</sup> / <sub>8</sub>		Gloss lacquer	L/V	700026574	1523
		Matt lacquer		700026573	1300
		Wood		700026575	1710
		Laminate R1		700030963	939
		Laminate R3		700026572	1014
		Laminate R4		700031063	1165
>60-80x52x48 >23 <sup>5</sup> / <sub>8</sub> -31 <sup>1</sup> / <sub>2</sub> x20 <sup>1</sup> / <sub>2</sub> x18 <sup>7</sup> / <sub>8</sub>		Gloss lacquer	L/V	700026578	1714
		Matt lacquer		700026577	1454
		Wood		700026579	1901
		Laminate R1		700030964	1033
		Laminate R3		700026576	1122
		Laminate R4		700031064	1314
>80-100x52x48 >31 <sup>1</sup> / <sub>2</sub> -39 <sup>3</sup> / <sub>8</sub> x20 <sup>1</sup> / <sub>2</sub> x18 <sup>7</sup> / <sub>8</sub>		Gloss lacquer	L/V	700026582	1895
		Matt lacquer		700026581	1594
		Wood		700026583	2070
		Laminate R1		700030965	1110
		Laminate R3		700026580	1212
		Laminate R4		700031065	1445
>100-120x52x48 39 <sup>3</sup> / <sub>8</sub> -47 <sup>1</sup> / <sub>4</sub> x20 <sup>1</sup> / <sub>2</sub> x18 <sup>7</sup> / <sub>8</sub>		Gloss lacquer	L/V	700026586	2040
		Matt lacquer		700026585	1713
		Wood		700026587	2254
		Laminate R1		700030966	1194
		Laminate R3		700026584	1310
		Laminate R4		700031066	1585

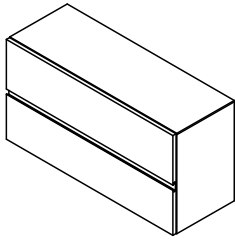

Wallmounted unit.

Modulo sospeso.

Тумба для ванной, монтируемая на стену.

MEASURES	( x  x )	FINISHES	HANDLE	SAP	POINTS
45-60x52x35 17 <sup>3/4</sup> -23 <sup>5/8</sup> x20 <sup>1/2</sup> x13 <sup>3/4</sup>		Gloss lacquer	LV	700031320	1428
		Matt lacquer		700031321	1216
		Wood		700031325	1611
		Laminate R1		700031323	910
		Laminate R3		700031322	971
		Laminate R4		700031324	1097
>60-80x52x35 >23 <sup>5/8</sup> -31 <sup>1/2</sup> x20 <sup>1/2</sup> x13 <sup>3/4</sup>		Gloss lacquer	LV	700031326	1612
		Matt lacquer		700031327	1360
		Wood		700031331	1784
		Laminate R1		700031329	994
		Laminate R3		700031328	1067
		Laminate R4		700031330	1229
>80-100x52x35 >31 <sup>1/2</sup> -39 <sup>3/8</sup> x20 <sup>1/2</sup> x13 <sup>3/4</sup>		Gloss lacquer	LV	700031332	1774
		Matt lacquer		700031333	1485
		Wood		700031337	1942
		Laminate R1		700031335	1064
		Laminate R3		700031334	1147
		Laminate R4		700031336	1347
>100-120x52x35 39 <sup>3/8</sup> -47 <sup>1/4</sup> x20 <sup>1/2</sup> x13 <sup>3/4</sup>		Gloss lacquer	LV	700031314	1914
		Matt lacquer		700031315	1632
		Wood		700031319	2121
		Laminate R1		700031317	1149
		Laminate R3		700031316	1243
		Laminate R4		700031318	1480

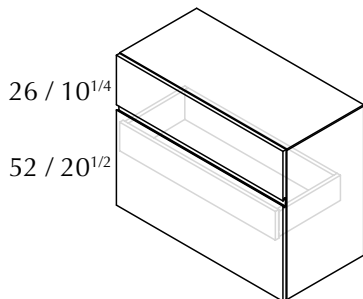

Wallmounted unit.

Modulo sospeso.

Тумба для ванной, монтируемая на стену.

MEASURES	(  )	FINISHES	HANDLE	SAP	POINTS
45x78x48	/ 17 <sup>3</sup> / <sub>4</sub> x30 <sup>3</sup> / <sub>4</sub> x18 <sup>7</sup> / <sub>8</sub>	Gloss lacquer	A/L/M/V	700026534	1801
		Matt lacquer		700026533	1552
		Wood		700026535	2030
		Laminate R1		700030967	1154
		Laminate R3		700026532	1239
		Laminate R4		700031067	1405
60x78x48	/ 23 <sup>5</sup> / <sub>8</sub> x30 <sup>3</sup> / <sub>4</sub> x18 <sup>7</sup> / <sub>8</sub>	Gloss lacquer	A/L/M/V	700026538	1957
		Matt lacquer		700026537	1673
		Wood		700026539	2194
		Laminate R1		700030968	1225
		Laminate R3		700026536	1322
		Laminate R4		700031068	1529
80x78x48	/ 31 <sup>1</sup> / <sub>2</sub> x30 <sup>3</sup> / <sub>4</sub> x18 <sup>7</sup> / <sub>8</sub>	Gloss lacquer	A/L/M/V	700026542	2190
		Matt lacquer		700026541	1858
		Wood		700026543	2423
		Laminate R1		700030969	1336
		Laminate R3		700026540	1448
		Laminate R4		700031069	1709
90x78x48	/ 35 <sup>3</sup> / <sub>8</sub> x30 <sup>3</sup> / <sub>4</sub> x18 <sup>7</sup> / <sub>8</sub>	Gloss lacquer	A/L/M/V	700026546	2299
		Matt lacquer		700026545	1941
		Wood		700026547	2523
		Laminate R1		700030970	1379
		Laminate R3		700026544	1499
		Laminate R4		700031070	1788
100x78x48	/ 39 <sup>3</sup> / <sub>8</sub> x30 <sup>3</sup> / <sub>4</sub> x18 <sup>7</sup> / <sub>8</sub>	Gloss lacquer	L/M/V	700026550	2417
		Matt lacquer		700026549	2034
		Wood		700026551	2634
		Laminate R1		700030971	1432
		Laminate R3		700026548	1560
		Laminate R4		700031071	1877
120x78x48	/ 47 <sup>1</sup> / <sub>4</sub> x30 <sup>3</sup> / <sub>4</sub> x18 <sup>7</sup> / <sub>8</sub>	Gloss lacquer	L/M/V	700026554	2626
		Matt lacquer		700026553	2204
		Wood		700026555	2868
		Laminate R1		700030972	1530
		Laminate R3		700026552	1674
		Laminate R4		700031072	2045

## FREESTANDING UNIT MS-2018

DEPTH 48 CM / 18<sup>7/8</sup>"

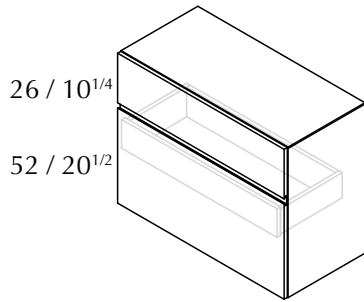

Wallmounted unit.

Modulo sospeso.

Тумба для ванной, монтируемая на стену.

MEASURES	(↔x↑x↗)	FINISHES	HANDLE	SAP	POINTS
45-60x78x48 17 <sup>3/4</sup> -23 <sup>5/8</sup> x30 <sup>3/4</sup> x18 <sup>7/8</sup>		Gloss lacquer	L/V	700026590	1957
		Matt lacquer		700026589	1673
		Wood		700026591	2194
		Laminate R1		700030973	1225
		Laminate R3		700026588	1322
		Laminate R4		700031073	1529
>60-80x78x48 >23 <sup>5/8</sup> -31 <sup>1/2</sup> x30 <sup>3/4</sup> x18 <sup>7/8</sup>		Gloss lacquer	L/V	700026594	2190
		Matt lacquer		700026593	1858
		Wood		700026595	2423
		Laminate R1		700030974	1336
		Laminate R3		700026592	1448
		Laminate R4		700031074	1709
>80-100x78x48 >31 <sup>1/2</sup> -39 <sup>3/8</sup> x30 <sup>3/4</sup> x18 <sup>7/8</sup>		Gloss lacquer	L/V	700026598	2417
		Matt lacquer		700026597	2034
		Wood		700026599	2634
		Laminate R1		700030975	1432
		Laminate R3		700026596	1560
		Laminate R4		700031075	1877
>100-120x78x48 39 <sup>3/8</sup> -47 <sup>1/4</sup> x30 <sup>3/4</sup> x18 <sup>7/8</sup>		Gloss lacquer	L/V	700026602	2626
		Matt lacquer		700026601	2204
		Wood		700026603	2868
		Laminate R1		700030976	1530
		Laminate R3		700026600	1674
		Laminate R4		700031076	2045

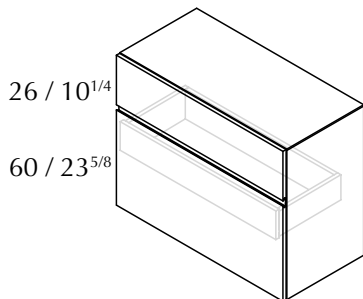

Wallmounted unit.

Modulo sospeso.

Тумба для ванной, монтируемая на стену.

MEASURES	()	FINISHES	HANDLE	SAP	POINTS
45x86x48 / 17 <sup>3</sup> / <sub>4</sub> x33 <sup>7</sup> / <sub>8</sub> x18 <sup>7</sup> / <sub>8</sub>		Gloss lacquer	L/M/V	700026894	1859
		Matt lacquer		700026895	1589
		Wood		700026897	2083
		Laminate R1		700030977	1165
		Laminate R3		700026896	1255
		Laminate R4		700031077	1436
60x86x48 / 23 <sup>5</sup> / <sub>8</sub> x33 <sup>7</sup> / <sub>8</sub> x18 <sup>7</sup> / <sub>8</sub>		Gloss lacquer	L/M/V	700026898	2021
		Matt lacquer		700026899	1714
		Wood		700026901	2252
		Laminate R1		700030978	1237
		Laminate R3		700026900	1339
		Laminate R4		700031078	1564
80x86x48 / 31 <sup>1</sup> / <sub>2</sub> x33 <sup>7</sup> / <sub>8</sub> x18 <sup>7</sup> / <sub>8</sub>		Gloss lacquer	L/M/V	700026902	2268
		Matt lacquer		700026903	1910
		Wood		700026905	2493
		Laminate R1		700030979	1352
		Laminate R3		700026904	1470
		Laminate R4		700031079	1755
90x86x48 / 35 <sup>3</sup> / <sub>8</sub> x33 <sup>7</sup> / <sub>8</sub> x18 <sup>7</sup> / <sub>8</sub>		Gloss lacquer	L/M/V	700026906	2380
		Matt lacquer		700026907	1994
		Wood		700026909	2595
		Laminate R1		700030980	1394
		Laminate R3		700026908	1520
		Laminate R4		700031080	1834
100x86x48 / 39 <sup>3</sup> / <sub>8</sub> x33 <sup>7</sup> / <sub>8</sub> x18 <sup>7</sup> / <sub>8</sub>		Gloss lacquer	L/M/V	700026886	2504
		Matt lacquer		700026887	2090
		Wood		700026889	2710
		Laminate R1		700030981	1449
		Laminate R3		700026888	1583
		Laminate R4		700031081	1926
120x86x48 / 47 <sup>1</sup> / <sub>4</sub> x33 <sup>7</sup> / <sub>8</sub> x18 <sup>7</sup> / <sub>8</sub>		Gloss lacquer	L/M/V	700026890	2725
		Matt lacquer		700026891	2269
		Wood		700026893	2955
		Laminate R1		700030982	1551
		Laminate R3		700026892	1701
		Laminate R4		700031082	2104

## FREESTANDING UNIT MS-2031

DEPTH 48 CM / 18<sup>7/8</sup>"

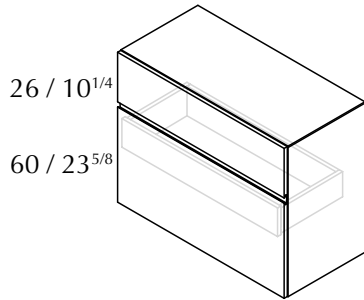

Wallmounted unit.

Modulo sospeso.

Тумба для ванной, монтируемая на стену.

MEASURES	()	FINISHES	HANDLE	SAP	POINTS
45-60x86x48 17 <sup>3/4</sup> -23 <sup>5/8</sup> x33 <sup>7/8</sup> x18 <sup>7/8</sup>		Gloss lacquer	L/V	700026914	2021
		Matt lacquer		700026915	1714
		Wood		700026917	2252
		Laminate R1		700030983	1237
		Laminate R3		700026916	1339
		Laminate R4		700031083	1564
>60-80x86x48 >23 <sup>5/8</sup> -31 <sup>1/2</sup> x33 <sup>7/8</sup> x18 <sup>7/8</sup>		Gloss lacquer	L/V	700026918	2268
		Matt lacquer		700026919	1910
		Wood		700026921	2493
		Laminate R1		700030984	1352
		Laminate R3		700026920	1470
		Laminate R4		700031084	1755
>80-100x86x48 >31 <sup>1/2</sup> -39 <sup>3/8</sup> x33 <sup>7/8</sup> x18 <sup>7/8</sup>		Gloss lacquer	L/V	700026922	2504
		Matt lacquer		700026923	2090
		Wood		700026925	2710
		Laminate R1		700030985	1449
		Laminate R3		700026924	1583
		Laminate R4		700031085	1926
>100-120x86x48 39 <sup>3/8</sup> -47 <sup>1/4</sup> x33 <sup>7/8</sup> x18 <sup>7/8</sup>		Gloss lacquer	L/V	700026910	2725
		Matt lacquer		700026911	2269
		Wood		700026913	2955
		Laminate R1		700030986	1551
		Laminate R3		700026912	1701
		Laminate R4		700031086	2104

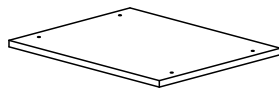

Optional base. For BPS-2007, BPS-2008 y BPS-2012 over mounted sink or BPS-2027, BPS-2028 and BPS-2029 with Sotto Box sink.

Mensola opzionale per: BPS-2007, BPS-2008, BPS-2012 con lavabo da appoggio sopra top. Oppure: BPS-2027, BPS-2028, BPS-2029 con lavabo sotto piano.

База опциональная. Для BPS-2007, BPS-2008 y BPS-2012 с раковиной на столешнице или BPS-2027, BPS-2028 y BPS-2029 с раковиной под столешницу (sotto).

MEASURES	(↔x↑□x↘)	FINISHES	SAP	POINTS
45-60x2x48 17 <sup>3</sup> / <sub>4</sub> -23 <sup>5</sup> / <sub>8</sub> x0 <sup>3</sup> / <sub>4</sub> x18 <sup>7</sup> / <sub>8</sub>		Gloss lacquer	700026638	196
		Matt lacquer	700026637	141
		Wood	700026639	226
		Laminate R1	700030987	86
		Laminate R3	700026636	98
		Laminate R4	700031087	123
>60-80x2x48 >23 <sup>5</sup> / <sub>8</sub> -31 <sup>1</sup> / <sub>2</sub> x0 <sup>3</sup> / <sub>4</sub> x18 <sup>7</sup> / <sub>8</sub>		Gloss lacquer	700026642	230
		Matt lacquer	700026641	165
		Wood	700026643	274
		Laminate R1	700030988	100
		Laminate R3	700026640	116
		Laminate R4	700031088	150
>80-100x2x48 >31 <sup>1</sup> / <sub>2</sub> -39 <sup>3</sup> / <sub>8</sub> x0 <sup>3</sup> / <sub>4</sub> x18 <sup>7</sup> / <sub>8</sub>		Gloss lacquer	700026650	270
		Matt lacquer	700026649	191
		Wood	700026651	317
		Laminate R1	700030989	113
		Laminate R3	700026648	133
		Laminate R4	700031089	175
>100-120x2x48 >39 <sup>3</sup> / <sub>8</sub> -47 <sup>1</sup> / <sub>4</sub> x0 <sup>3</sup> / <sub>4</sub> x18 <sup>7</sup> / <sub>8</sub>		Gloss lacquer	700026654	310
		Matt lacquer	700026653	216
		Wood	700026655	360
		Laminate R1	700030990	126
		Laminate R3	700026652	150
		Laminate R4	700031090	200



MSC 2119

DEPTH 30 CM / 11<sup>3/4</sup>"

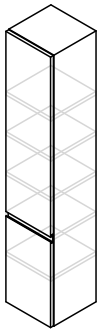

Tower unit with door. DX / SX.

Modulo colonna con anta. DX / SX.

Вертикальный блок с дверцей. DX / SX.

MEASURES	(  )	FINISHES	HANDLE	SAP	POINTS
30x156x30 / 11 <sup>3/4</sup> x61 <sup>3/8</sup> x11 <sup>3/4</sup>		Gloss lacquer	L/M	700031476	1534
		Matt lacquer		700031477	1186
		Wood		700031481	1636
		Laminate R1		700031479	732
		Laminate R3		700031478	808
		Laminate R4		700031480	1046
45x156x30 / 17 <sup>3/4</sup> x61 <sup>3/8</sup> x11 <sup>3/4</sup>		Gloss lacquer	L/M	700031374	1761
		Matt lacquer		700031375	1355
		Wood		700031379	1842
		Laminate R1		700031377	810
		Laminate R3		700031376	905
		Laminate R4		700031378	1228

last

## EST 2120 / EST 2121

DEPTH 48 CM / 18<sup>7</sup>/<sub>8</sub>"

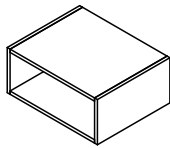

Custom-made shelves.

Mensole a misura.

Полки на заказ.

MEASURES	(  )	FINISHES	SAP	POINTS
15-30x26x48 5 <sup>7</sup> / <sub>8</sub> -11 <sup>3</sup> / <sub>4</sub> x10 <sup>1</sup> / <sub>4</sub> x18 <sup>7</sup> / <sub>8</sub>		Gloss lacquer	700031338	945
		Matt lacquer	700031339	753
		Wood	700031343	1032
		Laminate R1	700031341	383
		Laminate R3	700031340	406
		Laminate R4	700031342	465
>30-60x26x48 >11 <sup>3</sup> / <sub>4</sub> -23 <sup>5</sup> / <sub>8</sub> x10 <sup>1</sup> / <sub>4</sub> x18 <sup>7</sup> / <sub>8</sub>		Gloss lacquer	700031344	1203
		Matt lacquer	700031345	927
		Wood	700031349	1243
		Laminate R1	700031347	411
		Laminate R3	700031346	445
		Laminate R4	700031348	543

## EST 2122 / EST 2123

DEPTH 48 CM / 18<sup>7</sup>/<sub>8</sub>"

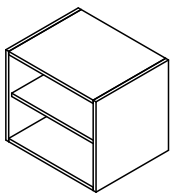

Custom-made shelves.

Mensole a misura.

Полки на заказ.

MEASURES	(  )	FINISHES	SAP	POINTS
15-30x52x48 5 <sup>7</sup> / <sub>8</sub> -11 <sup>3</sup> / <sub>4</sub> x20 <sup>1</sup> / <sub>2</sub> x18 <sup>7</sup> / <sub>8</sub>		Gloss lacquer	700031350	1332
		Matt lacquer	700031351	1028
		Wood	700031355	1397
		Laminate R1	700031353	451
		Laminate R3	700031352	489
		Laminate R4	700031354	594
>30-60x52x48 >11 <sup>3</sup> / <sub>4</sub> -23 <sup>5</sup> / <sub>8</sub> x20 <sup>1</sup> / <sub>2</sub> x18 <sup>7</sup> / <sub>8</sub>		Gloss lacquer	700031356	1714
		Matt lacquer	700031357	1298
		Wood	700031361	1756
		Laminate R1	700031359	492
		Laminate R3	700031358	547
		Laminate R4	700031360	717

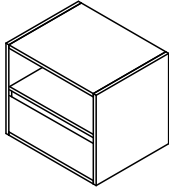
**EST+CAJ 2222 / EST+CAJ 2223**
**DEPTH 48 CM / 18<sup>7/8</sup>"**

**Custom-made shelves.**

 Mensole **a misura**.

Полки на заказ.

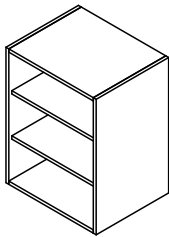
MEASURES	(xx)	FINISHES	HANDLE	SAP	POINTS
15-30x52x48 5 <sup>7/8</sup> -11 <sup>3/4</sup> x20 <sup>1/2</sup> x18 <sup>7/8</sup>		Gloss lacquer	L	700031392	1658
		Matt lacquer		700031393	1315
		Wood		700031397	1747
		Laminate R1		700031395	675
		Laminate R3		700031394	716
		Laminate R4		700031396	827
>30-60x52x48 >11 <sup>3/4</sup> -23 <sup>5/8</sup> x20 <sup>1/2</sup> x18 <sup>7/8</sup>		Gloss lacquer	A/L	700031398	2083
		Matt lacquer		700031399	1629
		Wood		700031403	2180
		Laminate R1		700031401	734
		Laminate R3		700031400	795
		Laminate R4		700031402	977

**EST 2124 / EST 2125**
**DEPTH 48 CM / 18<sup>7/8</sup>"**

**Custom-made shelves.**

 Mensole **a misura**.

Полки на заказ.

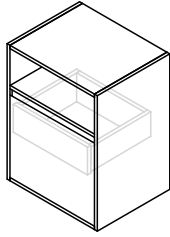
MEASURES	(xx)	FINISHES	SAP	POINTS
15-30x78x48 5 <sup>7/8</sup> -11 <sup>3/4</sup> x30 <sup>3/4</sup> x18 <sup>7/8</sup>		Gloss lacquer	700031362	1678
		Matt lacquer	700031363	1271
		Wood	700031367	1760
		Laminate R1	700031365	515
		Laminate R3	700031364	569
		Laminate R4	700031366	720
>30-60x78x48 >11 <sup>3/4</sup> -23 <sup>5/8</sup> x30 <sup>3/4</sup> x18 <sup>7/8</sup>		Gloss lacquer	700031368	2180
		Matt lacquer	700031369	1626
		Wood	700031373	2242
		Laminate R1	700031371	574
		Laminate R3	700031370	650
		Laminate R4	700031372	892



Custom-made shelves.

Mensole a misura.

Полки на заказ.

MEASURES	(x↑xx)	FINISHES	HANDLE	SAP	POINTS
15-30x78x48 5 <sup>7</sup> / <sub>8</sub> -11 <sup>3</sup> / <sub>4</sub> x30 <sup>3</sup> / <sub>4</sub> x18 <sup>7</sup> / <sub>8</sub>		Gloss lacquer	L	700031404	2239
		Matt lacquer		700031405	1788
		Wood		700031409	2384
		Laminate R1		700031407	943
		Laminate R3		700031406	1003
		Laminate R4		700031408	1167
>30-60x78x48 >11 <sup>3</sup> / <sub>4</sub> -23 <sup>5</sup> / <sub>8</sub> x30 <sup>3</sup> / <sub>4</sub> x18 <sup>7</sup> / <sub>8</sub>		Gloss lacquer	A/L	700031410	2871
		Matt lacquer		700031411	2244
		Wood		700031415	2998
		Laminate R1		700031413	1034
		Laminate R3		700031412	1123
		Laminate R4		700031414	1390

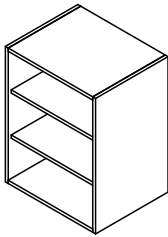

Custom-made shelves.

Mensole a misura.

Полки на заказ.

MEASURES	(x↑xx)	FINISHES	SAP	POINTS
15-30x86x48 5 <sup>7</sup> / <sub>8</sub> -11 <sup>3</sup> / <sub>4</sub> x33 <sup>7</sup> / <sub>8</sub> x18 <sup>7</sup> / <sub>8</sub>		Gloss lacquer	700031380	1746
		Matt lacquer	700031381	1316
		Wood	700031385	1855
		Laminate R1	700031383	523
		Laminate R3	700031382	580
		Laminate R4	700031384	741
>30-60x86x48 >11 <sup>3</sup> / <sub>4</sub> -23 <sup>5</sup> / <sub>8</sub> x33 <sup>7</sup> / <sub>8</sub> x18 <sup>7</sup> / <sub>8</sub>		Gloss lacquer	700031386	2233
		Matt lacquer	700031387	1676
		Wood	700031391	2306
		Laminate R1	700031389	583
		Laminate R3	700031388	662
		Laminate R4	700031390	918

EST 2232 / EST 2233

DEPTH 48 CM / 18<sup>7/8</sup>"

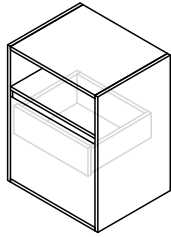

Custom-made shelves.

Mensole a misura.

Полки на заказ.

MEASURES	(xx)	FINISHES	HANDLE	SAP	POINTS
15-30x86x48 5 <sup>7/8</sup> -11 <sup>3/4</sup> x33 <sup>7/8</sup> x18 <sup>7/8</sup>		Gloss lacquer		700031416	2326
		Matt lacquer		700031417	1845
		Wood	L	700031421	2453
		Laminate R1		700031419	952
		Laminate R3		700031418	1016
		Laminate R4		700031420	1193
>30-60x86x48 >11 <sup>3/4</sup> -23 <sup>5/8</sup> x33 <sup>7/8</sup> x18 <sup>7/8</sup>		Gloss lacquer		700031422	2964
		Matt lacquer		700031423	2308
		Wood	L	700031427	3099
		Laminate R1		700031425	1052
		Laminate R3		700031424	1145
		Laminate R4		700031426	1432

EST 2150 / EST 2151

DEPTH 22 CM / 8<sup>5/8</sup>"

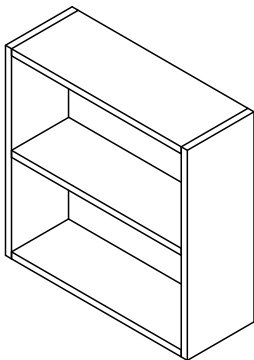

Custom-made shelves.

Mensole a misura.

Полки на заказ.

MEASURES	(xx)	FINISHES	SAP	POINTS
15-30x52x22 / 5 <sup>7/8</sup> -11 <sup>3/4</sup> x20 <sup>1/2</sup> x8 <sup>5/8</sup>		Gloss lacquer	700031428	959
		Matt lacquer	700031429	758
		Wood	700031433	1046
		Laminate R1	700031431	390
		Laminate R3	700031430	414
		Laminate R4	700031432	467
>30-60x52x22 / >11 <sup>3/4</sup> -23 <sup>5/8</sup> x20 <sup>1/2</sup> x8 <sup>5/8</sup>		Gloss lacquer	700031434	1137
		Matt lacquer	700031435	893
		Wood	700031439	1253
		Laminate R1	700031437	417
		Laminate R3	700031436	449
		Laminate R4	700031438	545

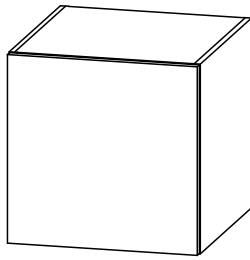

Upper unit with door. Gas-operated system.  
 Modulo pensile con anta. Sistema a gas.  
 Верхний блок с дверцей. Система газлифтов.

MEASURES	(  )	BODY FINISHES	HANDLE	SAP	POINTS
30-60x52x22 11 <sup>3</sup> / <sub>4</sub> -23 <sup>5</sup> / <sub>8</sub> x20 <sup>1</sup> / <sub>2</sub> x8 <sup>5</sup> / <sub>8</sub>		Gloss lacquer	T	700031440	1054
		Matt lacquer	T	700031441	868
		Wood	T	700031445	1206
		Laminate R1	T	700031443	601
		Laminate R3	T	700031442	647
		Laminate R4	T	700031444	761
>60-90x52x22 >23 <sup>5</sup> / <sub>8</sub> -35 <sup>3</sup> / <sub>8</sub> x20 <sup>1</sup> / <sub>2</sub> x8 <sup>5</sup> / <sub>8</sub>		Gloss lacquer	T	700031446	1243
		Matt lacquer	T	700031447	994
		Wood	T	700031451	1373
		Laminate R1	T	700031449	644
		Laminate R3	T	700031448	690
>90-120x52x22 >35 <sup>3</sup> / <sub>8</sub> -47 <sup>1</sup> / <sub>4</sub> x20 <sup>1</sup> / <sub>2</sub> x8 <sup>5</sup> / <sub>8</sub>		Laminate R4	T	700031450	872
		Gloss lacquer	T	700031452	1432
		Matt lacquer	T	700031453	1125
		Wood	T	700031457	1555
		Laminate R1	T	700031455	685
		Laminate R3	T	700031454	744
		Laminate R4	T	700031456	980

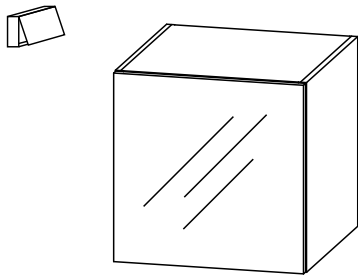

Upper unit with door. Gas-operated system. Mirror front.  
 Modulo pensile con anta. Sistema a gas. Frontale a specchio.  
 Верхний блок с дверцей. Система газлифтов. Зеркальный фасад.

MEASURES	(x x x)	BODY FINISHES	HANDLE	SAP	POINTS
30-60x52x22 11 <sup>3</sup> / <sub>4</sub> -23 <sup>5</sup> / <sub>8</sub> x20 <sup>1</sup> / <sub>2</sub> x8 <sup>5</sup> / <sub>8</sub>		Gloss lacquer	T	700031458	1024
		Matt lacquer	T	700031459	884
		Wood	T	700031463	1198
		Laminate R1	T	700031461	690
		Laminate R3	T	700031460	724
		Laminate R4	T	700031462	808
>60-90x52x22 >23 <sup>5</sup> / <sub>8</sub> -35 <sup>3</sup> / <sub>8</sub> x20 <sup>1</sup> / <sub>2</sub> x8 <sup>5</sup> / <sub>8</sub>		Gloss lacquer	T	700031464	1182
		Matt lacquer	T	700031465	997
		Wood	T	700031469	1374
		Laminate R1	T	700031467	756
		Laminate R3	T	700031466	797
>90-120x52x22 >35 <sup>3</sup> / <sub>8</sub> -47 <sup>1</sup> / <sub>4</sub> x20 <sup>1</sup> / <sub>2</sub> x8 <sup>5</sup> / <sub>8</sub>		Gloss lacquer	T	700031470	1338
		Matt lacquer	T	700031471	1111
		Wood	T	700031475	1502
		Laminate R1	T	700031473	813
		Laminate R3	T	700031472	861
		Laminate R4	T	700031474	1025

## SLIM BASIN

DEPTH 49CM / 19<sup>1</sup>/<sub>4</sub>"

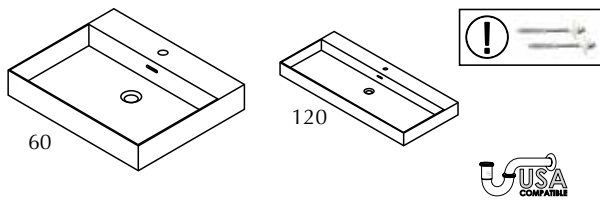

- GELCOAT basin with overflow.
- Requires for installation valve SAP100200010, 72 P.
- Lavabo GELCOAT con troppopieno.
- Richiede valvola SAP100200010, 72 P.
- Раковина GELCOAT с переливом.
- Требуется установка клапана SAP100200010, 72 P.



MEASURES	()	FINISHES	SAP	POINTS
60x10x49	/ 23 <sup>5</sup> / <sub>8</sub> x3 <sup>7</sup> / <sub>8</sub> x19 <sup>1</sup> / <sub>4</sub>	GELCOAT	100221199	596
80x10x49	/ 31 <sup>1</sup> / <sub>2</sub> x3 <sup>7</sup> / <sub>8</sub> x19 <sup>1</sup> / <sub>4</sub>		100221201	682
90x10x49	/ 35 <sup>3</sup> / <sub>8</sub> x3 <sup>7</sup> / <sub>8</sub> x19 <sup>1</sup> / <sub>4</sub>		100221203	765
100x10x49	/ 39 <sup>3</sup> / <sub>8</sub> x3 <sup>7</sup> / <sub>8</sub> x19 <sup>1</sup> / <sub>4</sub>		100241700	784
120x10x49	/ 47 <sup>1</sup> / <sub>4</sub> x3 <sup>7</sup> / <sub>8</sub> x19 <sup>1</sup> / <sub>4</sub>		100221205	822
① FIXINGS / ANCLAJE PARED. 60/80/90/100 (1UND.) - 120 (2UNDS.)			250010391	9

## SLIM BASIN

## COUNTERTOP / SOBRE ENCIMERA / VASQUE SUR PLAN

## REQUIRES WORKTOP

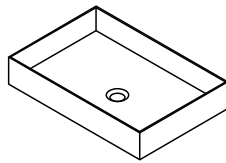

- GELCOAT basin. **REQUIRES WORKTOP.**
- Requires for installation valve SAP100036254, 68 P.
- Lavabo GELCOAT. **RICHIEDE TOP IN.**
- Richiede valvola SAP100036254, 68 P.
- Раковина GELCOAT. **НУЖДАЕТСЯ В СТОЛЕШНИЦЕ.**
- Требуется установка клапана SAP100036254, 68 P.



MEASURES	()	FINISHES	SAP	POINTS
50x10x33	/ 19 <sup>5</sup> / <sub>8</sub> x3 <sup>7</sup> / <sub>8</sub> x13	GELCOAT	100221198	475

## SOTTO NOVA

## RECESSED SINK

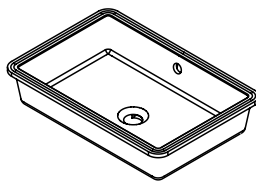

- Ceramic basin. **REQUIRES WORKTOP.**
- Lavabo in ceramica. **RICHIEDE TOP.**
- Керамическая раковина. **НУЖДАЕТСЯ В СТОЛЕШНИЦЕ.**



MEASURES	()	FINISHES	SAP	POINTS
50x14,2x34	/ 19 <sup>5</sup> / <sub>8</sub> x5 <sup>5</sup> / <sub>8</sub> x13 <sup>3</sup> / <sub>8</sub>	White ceramic	100241696	253
62x14,2x34	/ 24 <sup>3</sup> / <sub>8</sub> x5 <sup>5</sup> / <sub>8</sub> x13 <sup>3</sup> / <sub>8</sub>		100286592	370



## FIT BASIN

DEPTH 49CM / 19 1/4"

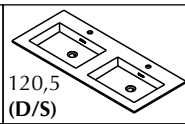
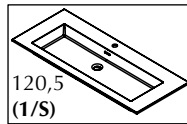
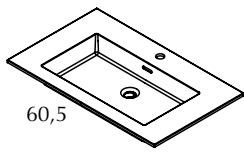

- GELCOAT basin with overflow.
- Requires for installation valve SAP100200010, 72 P.
- Lavabo GELCOAT con troppopieno.
- Richiede valvola SAP100200010, 72 P.
- Раковина GELCOAT с переливом.
- Требуется установка клапана SAP100200010, 72 P.



MEASURES	(x) (x) (x)	FINISHES	SAP	POINTS
60,5x13,5x49 / 23 7/8x5 3/8x19 1/4			100241712	427
80,5x13,5x49 / 31 3/4x5 3/8x19 1/4			100241723	532
90,5x13,5x49 / 35 5/8x5 3/8x19 1/4		GELCOAT	100241702	596
100,5x13,5x49 / 39 5/8x5 3/8x19 1/4			100241627	659
120,5x13,5x49 / 47 1/2x5 3/8x19 1/4 (1/S)			100241693	794
120,5x13,5x49 / 47 1/2x5 3/8x19 1/4 (D/S)			100296392	898

## ONES BASIN SEMI-RECESSED

DEPTH 48CM / 18 7/8"

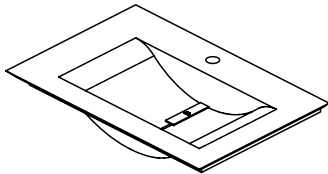

- GELCOAT basin. **REQUIRES WORKTOP.**
- Lavabo GELCOAT. **RICHIÈDE TOP IN.**
- Раковина GELCOAT. **НУЖДАЕТСЯ В СТОЛЕШНИЦЕ.**



- Optional black plate (250055696 / 150 points).
- Copripiletta nero opzionale (250055696 / 150 punti).
- Опционально черная накладка (250055696 / 150 пунктов).



MEASURES	(x) (x) (x)	FINISHES	SAP	POINTS
60x13x48 / 23 5/8x5 1/8x18 7/8			100110452	0942
71,5x13x48 / 28 1/8x5 1/8x18 7/8		GELCOAT	100100508	0982
115x13x48 / 45 1/4x5 1/8x18 7/8			100100507	1202

## CICLO BASIN SEMI-RECESSED

DEPTH 48CM / 18<sup>7</sup>/<sub>8</sub>"

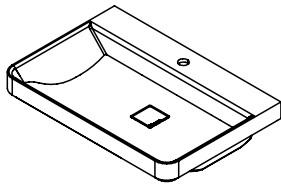

- GELCOAT basin. **REQUIRES WORKTOP.**
- It requires permanent overflow (100104178 / 59 Points).
- Lavabo GELCOAT. **RICHIESTE TOP IN.**
- Richiede valvola (100104178 / 59 punti).
- Раковина GELCOAT. **НУЖДАЕТСЯ В СТОЛЕШНИЦЕ.**
- Требуется постоянный перелив (100104178 / 59 позиций).



- Optional black plate (250055710 / 143 points).
- Copripiletta nero opzionale (250055710 / 143 punti).
- Опционально черная накладка (250055710 / 143 пунктов).

MEASURES	FINISHES	SAP	POINTS
50x15x48 / 19 <sup>5</sup> / <sub>8</sub> x5 <sup>7</sup> / <sub>8</sub> x18 <sup>7</sup> / <sub>8</sub>	GELCOAT	100136309	632
70x15x48 / 27 <sup>1</sup> / <sub>2</sub> x5 <sup>7</sup> / <sub>8</sub> x18 <sup>7</sup> / <sub>8</sub>		100128501	736

## BASIN

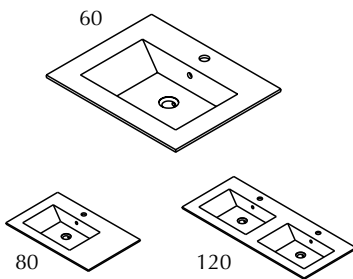

- GELCOAT basin with overflow.
- Requires for installation valve SAP100200010, 72 P.**
- Lavabo GELCOAT con troppopieno.
- Richiede valvola SAP100200010, 72 P.**
- Раковина GELCOAT с переливом.
- Требуется установка клапана SAP100200010, 72 P.

MEASURES	FINISHES	SAP	POINTS
60,5x14,1x49,2 / 23 <sup>7</sup> / <sub>8</sub> x5 <sup>1</sup> / <sub>2</sub> x19 <sup>3</sup> / <sub>8</sub>	GELCOAT	100160956	0560
80,5x14,1x49,2 / 31 <sup>3</sup> / <sub>4</sub> x5 <sup>1</sup> / <sub>2</sub> x19 <sup>3</sup> / <sub>8</sub>		100160957	0582
120,5x14,1x49,2 / 47 <sup>1</sup> / <sub>2</sub> x5 <sup>1</sup> / <sub>2</sub> x19 <sup>3</sup> / <sub>8</sub>		100171860	0981

## WORKTOPS NEXT EDITION GELCOAT

DEPTH 35CM / 13<sup>3</sup>/<sub>4</sub>"

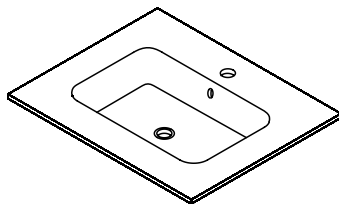

- GELCOAT basin with overflow.
- Requires for installation valve SAP100200010, 72 P.**
- Lavabo GELCOAT con troppopieno.
- Richiede valvola SAP100200010, 72 P.**
- Раковина GELCOAT с переливом.
- Требуется установка клапана SAP100200010, 72 P.

MEASURES	FINISHES	SAP	POINTS
60,2x13x35 / 23 <sup>5</sup> / <sub>8</sub> x5 <sup>1</sup> / <sub>8</sub> x13 <sup>3</sup> / <sub>4</sub>	GELCOAT	100176531	562
45,2x13x35 / 17 <sup>3</sup> / <sub>4</sub> x5 <sup>1</sup> / <sub>8</sub> x13 <sup>3</sup> / <sub>4</sub>		100213646	496

## WORKTOP KRION STONE

DEPTH 49,2CM / 19<sup>3/8</sup>"

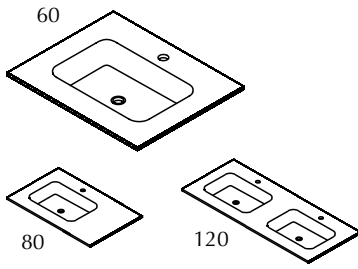

- Worktop KRION STONE with integrated basin.
- Requires for installation permanent valve SAP100036254, 68 P.
- Requires drainage SAP100036255, 103 P.
- Top in KRION STONE con lavabo integrato.
- Richiede valvola SAP100036254, 68 P.
- Richiede scarico SAP100036255, 103 P.
- Столешница KRION STONE со встроенной раковиной.
- Требуется установка постоянного клапана SAP100036254, 68 P.
- Требуется дренаж SAP100036255, 103 P.

MEASURES	(xx)	FINISHES	SAP	POINTS
60,2x13x49,2 / 23 <sup>5/8</sup> x5 <sup>1/8</sup> x19 <sup>3/8</sup>			100091017	617
80,2x13x49,2 / 31 <sup>1/2</sup> x5 <sup>1/8</sup> x19 <sup>3/8</sup>		Krion STONE	100091018	660
120,2x13x49,2 / 47 <sup>3/8</sup> x5 <sup>1/8</sup> x19 <sup>3/8</sup>			100110448	1356

## CUSTOM MIRROR

ESP-RANGO								
	15-30 cm. 5 <sup>7/8</sup> -11 <sup>3/4</sup>	30,1-60 cm. 11 <sup>7/8</sup> -23 <sup>5/8</sup>	60,1-90 cm. 23 <sup>5/8</sup> -35 <sup>3/8</sup>	90,1-120 cm. 35 <sup>1/2</sup> -47 <sup>1/4</sup>	120,1-150 cm. 47 <sup>1/4</sup> -59	150,1-180 cm. 59 <sup>1/8</sup> -70 <sup>7/8</sup>	180,1-210 cm. 70 <sup>7/8</sup> -82 <sup>5/8</sup>	
	15-30 cm. 5 <sup>7/8</sup> -11 <sup>3/4</sup>	SAP 700026272 164 P.	SAP 700026312 177 P.	SAP 700026275 189 P.	SAP 700026276 222 P.	SAP 700026293 251 P.	SAP 700026320 283 P.	SAP 700026315 310 P.
	30,1-60 cm. 11 <sup>7/8</sup> -23 <sup>5/8</sup>	SAP 700026304 182 P.	SAP 700026305 208 P.	SAP 700026303 241 P.	SAP 700026285 293 P.	SAP 700026294 340 P.	SAP 700026306 378 P.	SAP 700026277 422 P.
	60,1-90 cm. 23 <sup>5/8</sup> -35 <sup>3/8</sup>	SAP 700026307 195 P.	SAP 700026278 241 P.	SAP 700026279 285 P.	SAP 700026273 347 P.	SAP 700026237 414 P.	SAP 700026238 484 P.	SAP 700026282 539 P.
	90,1-120 cm. 35 <sup>1/2</sup> -47 <sup>1/4</sup>	SAP 700026313 218 P.	SAP 700026283 282 P.	SAP 700026314 337 P.	SAP 700026284 418 P.	SAP 700026302 514 P.	SAP 700026274 675 P.	SAP 700026239 754 P.



The interpretation made in inches for the dimensions of the different items shown in the price list has been rounded to 1/8, however for a more accurate measurement please use millimetres or centimetres.

## Mertens

<b>EXTERIOR FINISHES</b> FINITURE ESTERNE ОТДЕЛКА ДЛЯ НАРУЖНОГО ИСПОЛЬЗОВАНИЯ	<input type="checkbox"/> Laminate Laminato ЛАМИНАТ	<input type="checkbox"/> Matt lacquer Laccato opaco МАТОВЫЙ ЛАК	<input checked="" type="checkbox"/> Wood veneer Legno ДЕРЕВО
	<input type="checkbox"/> HPL Stratificato СЛОИСТАЯ	<input type="checkbox"/> Gloss lacquer Laccato lucido ГЛЯНЦЕВЫЙ ЛАК	<input type="checkbox"/> Aluminium, Metal finish Alluminio, finitura Metal Алюминий, отделка Metal
<b>INTERIOR FINISHES</b> FINITURE INTERNE ОТДЕЛКА ДЛЯ ВНУТРЕННЕГО ИСПОЛЬЗОВАНИЯ	<input type="checkbox"/> Laminate Laminato ЛАМИНАТ	<input type="checkbox"/> Wood veneer Legno ДЕРЕВО	<input checked="" type="checkbox"/> Aluminium+laminated base Alluminio + base in laminato Алюминий + основа из ламината
	<input type="checkbox"/> Front handle Maniglia frontale a vista Декоративная передняя ручка	<input type="checkbox"/> Integrated metal handle Maniglia metallica integrata Встроенная металлическая ручка	<input checked="" type="checkbox"/> Integrated mechanized h. Maniglia integrata ricavata sul bordo Встроенная ручка по краю
<b>HANDLES</b> MANIGLIE РУЧКИ	<input type="checkbox"/> Push handle Maniglia Push РУЧКИ Push		
<b>TYPE OF UNITS</b> TIPI DI MODULI ТИПЫ МОДУЛЕЙ	<input checked="" type="checkbox"/> Compact Compatto Компактная	<input type="checkbox"/> Modular Modulare Модульная	
<b>POSITION</b> POSIZIONE ПОЗИЦИЯ	<input checked="" type="checkbox"/> Wall-mounted Sospeso Подвесная	<input type="checkbox"/> Floor-mounted A terra Напольная	
<b>MEASURES (CM)</b> DIMENSIONI РАЗМЕРЫ	72 / 102 / 132 28 <sup>3/8</sup> / 40 <sup>1/8</sup> / 52	11 4 <sup>3/8</sup>	53 20 <sup>7/8</sup>
<b>WORKTOP &amp; BASIN OPTIONS</b> OPZIONI TOP E LAVABI ВАРИАНТЫ СТОЛЕШНИЦ И УМЫВАЛЬНЫХ РАКОВИН	<input checked="" type="checkbox"/> Bath serie's worktop / basin Lavabo / top della serie Серийная умывальная раковина / столешница	<input type="checkbox"/> Standard worktops Top standard Стандартные столешницы	<input checked="" type="checkbox"/> Worktop + integrated basin Encimera + lavabo integrato Столешница + встроенная умывальная раковина
	<input type="checkbox"/> Over-mounted basin Lavabo da appoggio Настольная умывальная раковина	<input type="checkbox"/> Under-mounted basin Lavabo sottopiano Умывальная раковина, встраиваемая в столешницу снизу	<input checked="" type="checkbox"/> Double basin as option Opzione doppia vasca Вариант с двойной чашей
<b>WORKTOP FINISHES</b> FINITURE TOP ОТДЕЛКА СТОЛЕШНИЦ	<input type="checkbox"/> Krion® worktop Top in KRION® Столешница KRION®	<input type="checkbox"/> Gel Coat worktop Top in Gel Coat Столешница с покрытием гелькоут	<input type="checkbox"/> Natural Stone worktop Top in pietra naturale Столешница из натурального камня.
	<input checked="" type="checkbox"/> Glass worktop Top in vetro Столешница из стекла	<input type="checkbox"/> Bath furniture finish worktop Top con la finitura del mobile Столешница с той же отделкой, что и консоль/тумба	
<b>BASIN FINISHES</b> FINITURE LAVABI ОТДЕЛКА УМЫВАЛЬНЫХ РАКОВИН	<input type="checkbox"/> Krion® basin Lavabo in Krion® Умывальная раковина из Krion®	<input type="checkbox"/> Gel Coat basin Lavabo Gelcoat Раковина Gelcoat	<input type="checkbox"/> Ceramic basin Lavabo in ceramica Керамическая умывальная раковина
	<input type="checkbox"/> Natural Stone basin Lavabo in pietra naturale Умывальная раковина из натурального камня.		
<b>ACCESSORIES</b> ACCESSORI АКСЕССУАРЫ	<input checked="" type="checkbox"/> Mirror Specchio Зеркало	<input checked="" type="checkbox"/> Wall-mounted module Modulo sospeso Подвесной модуль	<input type="checkbox"/> Tall cabinet Modulo colonna Высокий шкаф
	<input checked="" type="checkbox"/> Upper unit Modulo alto Верхний модуль	<input type="checkbox"/> Organizer Organizzatore Органайзер	<input type="checkbox"/> Shelves Mensola Полка
			<input type="checkbox"/> Accessories Accessori Аксессуары

*mertens*

mertens

Mertens is a bathroom unit made up of a scratch and smudge-proof wall-hung glass countertop, with an oak bevel-edged underframe to conceal the wall fixtures, plus wall-hung units for added storage capacity and a mirror with storage space behind the glass.

Mertens è un mobile da bagno che presenta un top sospeso in vetro, con trattamento antigraffio e antimpronta, rifinito nella parte inferiore con un telaio bisellato in rovere che nasconde le staffe di supporto a parete, mentre i moduli sospesi e lo specchio - che cela lo spazio interno per riporre oggetti - dotano l'insieme di una grande capacità di stoccaggio.

Mertens — это мебель для ванной комнаты, включающая подвесную стеклянную столешницу с обработкой против царапин и следов пальцев. Внизу столешница имеет дубовую раму со скошенной кромкой, скрывающую крепежные детали, с помощью которых мебель держится на стене. Другие элементы — подвесные модули для хранения различных предметов и зеркало с потайным внутренним пространством, куда тоже можно складывать разные вещи.

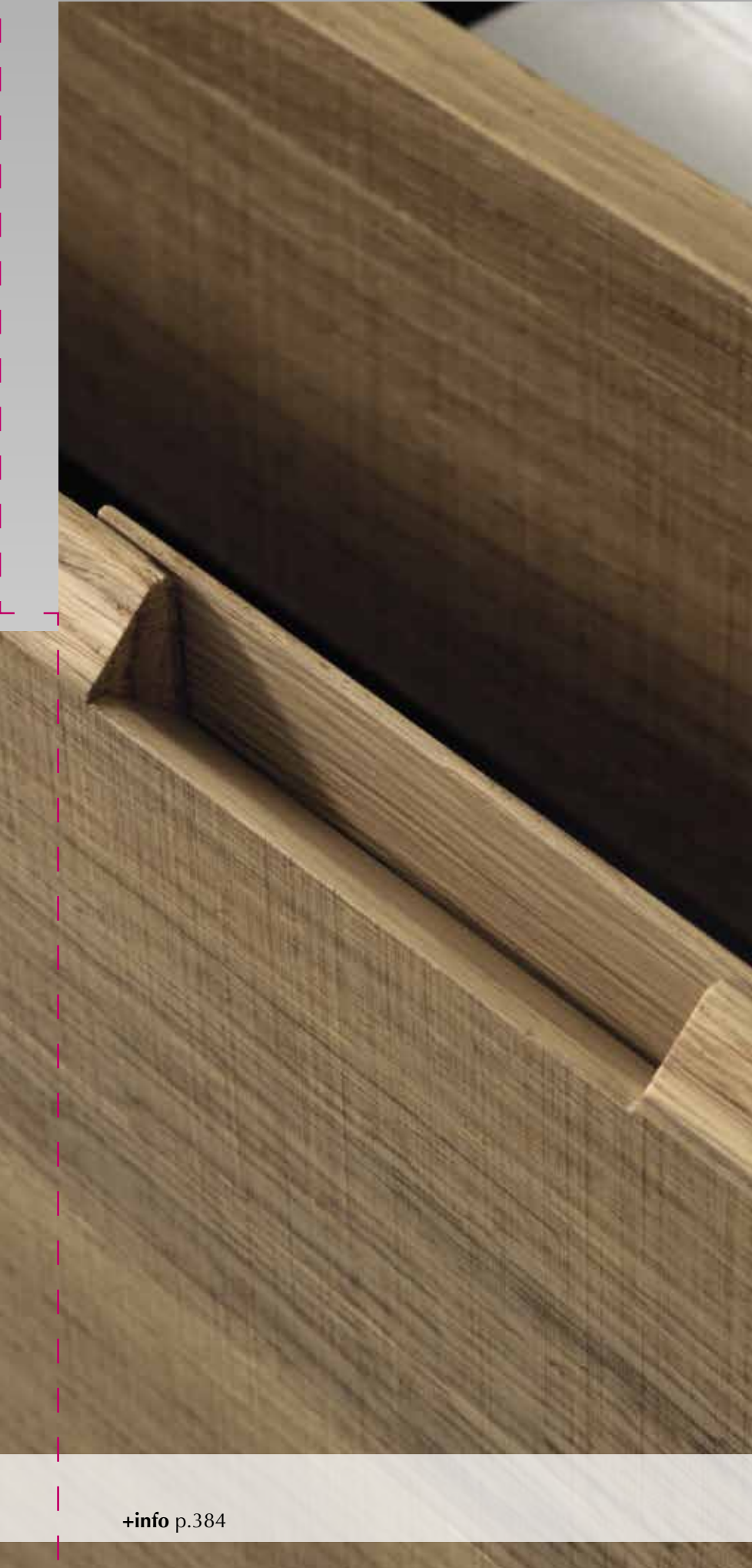

+info p.384

# highline



mertens



9129 Points  
MERTENS roble puro / cristal taupe

**FINISHES**

**WOOD** **LEGNO** **ДЕРЕВО**



Roble Noche R.



Roble Cobre R.



Roble Bronce R.

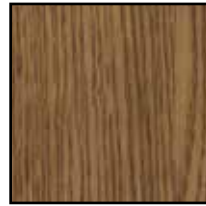

Roble Sil R.



Roble Alba R.



Roble Carbón R.



Roble Cuero R.



Roble Polvo R.



Roble Puro R.



**WORKTOPS** **TOP** **СТОЛЕШНИЦЫ**

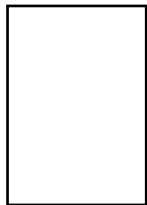

Cristal Blanco



Cristal Negro



Cristal Taupe



**BPS-1**

**DEPTH 53CM / 20<sup>7/8</sup>"**



Wash basin unit.

Basi portalavabo

Тумбочка под умывальник.



MEASURES	(xx)	FINISHES	SAP	POINTS
72x5x53	/ 28 <sup>3/8</sup> x2x20 <sup>7/8</sup>	Wood	700023506	1239

**ENC. MERTENS**

**DEPTH 53CM / 20<sup>7/8</sup>"**

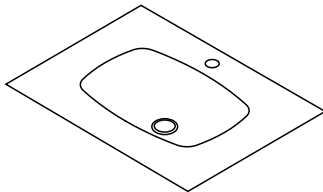

-Basin. It requires BPS-1.  
-It requires valve (100036254 / 68 Points).  
-It requires drainage (100190984 / 210 Points).

-Lavabo. Richiede BPS-1.  
-Richiede valvola (100036254 / 68 punti).  
-Richiede scarico (100190984 / 210 Points).

-Раковина. Требуется BPS-1.  
-Требуется постоянный перелив (100036254 / 68 позиций).  
-Требуется дренаж (100190984 / 210 Points).



MEASURES	(xx)	FINISHES	SAP	POINTS
72x11x53	/ 28 <sup>3/8</sup> x4 <sup>3/8</sup> x20 <sup>7/8</sup>	CR. BLANCO	100221179	1117
		CR. NEGRO	100221183	1117
		CR. TAUPE	100221187	1117

**BPS-1**

**DEPTH 53CM / 20<sup>7/8</sup>"**

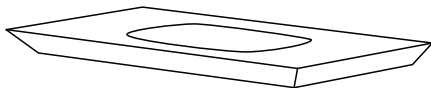

Wash basin unit.

Basi portalavabo

Тумбочка под умывальник.



MEASURES	(xx)	FINISHES	SAP	POINTS
102x5x53	/ 40 <sup>1/8</sup> x2x20 <sup>7/8</sup>	Wood	700023507	1370

**ENC. MERTENS**

**DEPTH 53CM / 20<sup>7/8</sup>"**

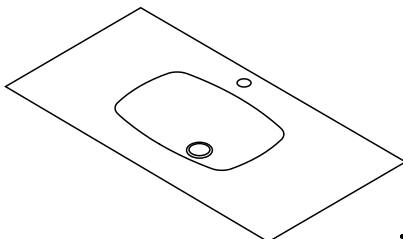

-Basin. It requires BPS-1.  
-It requires valve (100036254 / 68 Points).  
-It requires drainage (100190984 / 210 Points).

-Lavabo. Richiede BPS-1.  
-Richiede valvola (100036254 / 68 punti).  
-Richiede scarico (100190984 / 210 Points).

-Раковина. Требуется BPS-1.  
-Требуется постоянный перелив (100036254 / 68 позиций).  
-Требуется дренаж (100190984 / 210 Points).



MEASURES	(xx)	FINISHES	SAP	POINTS
102x11x53	/ 40 <sup>1/8</sup> x4 <sup>3/8</sup> x20 <sup>7/8</sup>	CR. BLANCO	100221180	1551
		CR. NEGRO	100221184	1551
		CR. TAUPE	100221188	1551

mertens

## BPS-1

DEPTH 53CM / 20<sup>7/8</sup>"

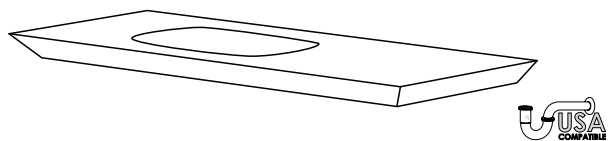

Wash basin unit.

Basi portalavabo

Тумбочка под умывальник.



MEASURES	FINISHES	SAP	POINTS
132x5x53 / 52x2x20 <sup>7/8</sup>	Wood	700023508	1534

## ENC. MERTENS

DEPTH 53CM / 20<sup>7/8</sup>"

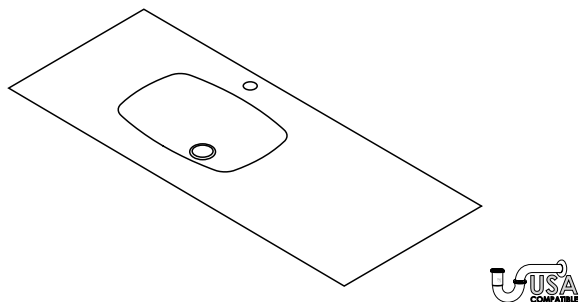

-Basin. It requires BPS-1.

-It requires valve (100036254 / 68 Points).

-It requires drainage (100190984 / 210 Points).

-Lavabo. Richiede BPS-1.

-Richiede valvola (100036254 / 68 punti).

-Richiede scarico (100190984 / 210 Points).

-Раковина. Требуется BPS-1.

-Требуется постоянный перелив (100036254 / 68 позиций).

-Требуется дренаж (100190984 / 210 Points).



MEASURES	FINISHES	SAP	POINTS
132x11x53 / 52x4 <sup>3/8</sup> x20 <sup>7/8</sup>	CR. BLANCO	100221181	1986
	CR. NEGRO	100221185	1986
	CR. TAUPE	100221189	1986

## BPS-1 D/S

DEPTH 53CM / 20<sup>7/8</sup>"

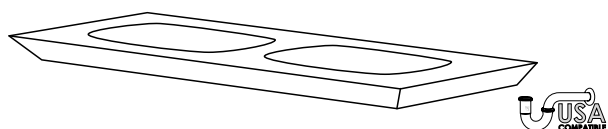

Wash basin unit.

Basi portalavabo

Тумбочка под умывальник.



MEASURES	FINISHES	SAP	POINTS
132x5x53 / 52x2x20 <sup>7/8</sup>	Wood	700023509	1534

## ENC. MERTENS D/S

DEPTH 53CM / 20<sup>7/8</sup>"

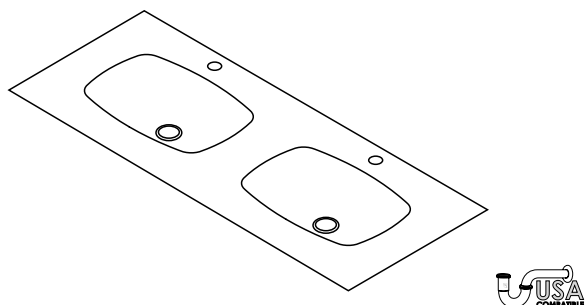

-Basin. It requires BPS-1 D/S.

-It requires valve (100036254 / 68 Points).

-It requires drainage (100190984 / 210 Points).

-Lavabo. Richiede BPS-1 D/S.

-Richiede valvola (100036254 / 68 punti).

-Richiede scarico (100190984 / 210 Points).

-Раковина. Требуется BPS-1 D/S.

-Требуется постоянный перелив (100036254 / 68 позиций).

-Требуется дренаж (100190984 / 210 Points).



MEASURES	FINISHES	SAP	POINTS
132x11x53 / 40 <sup>1/8</sup> x4 <sup>3/8</sup> x20 <sup>7/8</sup>	CR. BLANCO	100221182	2234
	CR. NEGRO	100221186	2234
	CR. TAUPE	100221190	2234

## DRAINAGE



-Drainage.  
-Scarico.  
-Дренаж.

FINISHES	SAP	POINTS
Chrome	100190984	210
Black matt lacquer	100242315	255

LA

## MS-1

DEPTH 51CM / 20<sup>1/8</sup>"

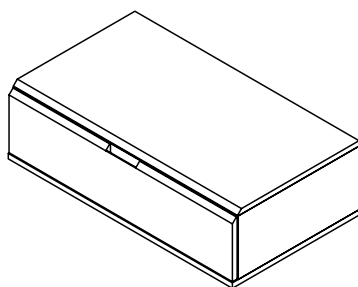

Wallmounted unit.  
Modulo sospeso  
Тумба для ванной, монтируемая на стену.

MEASURES (x)x(x)x(x)	FINISHES	SAP	POINTS
60x26x51 / 23 <sup>5/8</sup> x10 <sup>1/4</sup> x20 <sup>1/8</sup>	Wood	700023510	2062
90x26x51 / 35 <sup>3/8</sup> x10 <sup>1/4</sup> x20 <sup>1/8</sup>		700023511	2402
120x26x51 / 47 <sup>1/4</sup> x10 <sup>1/4</sup> x20 <sup>1/8</sup>		700023512	2744

## MS-2

DEPTH 51CM / 20<sup>1/8</sup>"

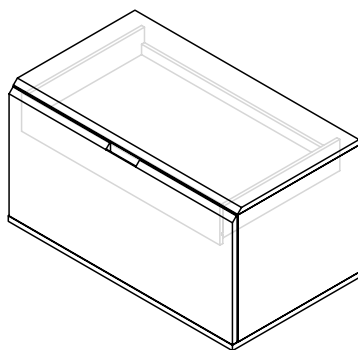

Wallmounted unit.  
Modulo sospeso  
Тумба для ванной, монтируемая на стену.

MEASURES (x)x(x)x(x)	FINISHES	SAP	POINTS
60x48x51 / 23 <sup>5/8</sup> x18 <sup>7/8</sup> x20 <sup>1/8</sup>	Wood	700023513	2846
90x48x51 / 35 <sup>3/8</sup> x18 <sup>7/8</sup> x20 <sup>1/8</sup>		700023514	3352
120x48x51 / 47 <sup>1/4</sup> x18 <sup>7/8</sup> x20 <sup>1/8</sup>		700023515	3820

MS



The interpretation made in inches for the dimensions of the different items shown in the price list has been rounded to 1/8, however for a more accurate measurement please use millimetres or centimetres.

## Duna

<b>EXTERIOR FINISHES</b> FINITURE ESTERNE ОТДЕЛКА ДЛЯ НАРУЖНОГО ИСПОЛЬЗОВАНИЯ	<input type="checkbox"/> Laminate Laminato ЛАМИНАТ	<input checked="" type="checkbox"/> Matt lacquer Laccato opaco МАТОВЫЙ ЛАК	<input checked="" type="checkbox"/> Wood veneer Legno ДЕРЕВО
	<input type="checkbox"/> HPL Stratificato СЛОИСТАЯ	<input checked="" type="checkbox"/> Gloss lacquer Laccato lucido ГЛЯНЦЕВЫЙ ЛАК	<input checked="" type="checkbox"/> Aluminium, Metal finish Alluminio, finitura Metal Алюминий, отделка Metal
<b>INTERIOR FINISHES</b> FINITURE INTERNE ОТДЕЛКА ДЛЯ ВНУТРЕННЕГО ИСПОЛЬЗОВАНИЯ	<input type="checkbox"/> Laminate Laminato ЛАМИНАТ	<input type="checkbox"/> Wood veneer Legno ДЕРЕВО	<input checked="" type="checkbox"/> Aluminium+laminato base Alluminio + base in laminato Алюминий + основа из ламината
	<input type="checkbox"/> Front handle Maniglia frontale a vista Декоративная передняя ручка	<input type="checkbox"/> Integrated metal handle Maniglia metallica integrata Встроенная металлическая ручка	<input checked="" type="checkbox"/> Integrated mechanized h. Maniglia integrata ricavata sul bordo Встроенная ручка по краю
<b>HANDLES</b> MANIGLIE РУЧКИ	<input type="checkbox"/> Push handle Maniglia Push РУЧКИ Push		
<b>TYPE OF UNITS</b> TIPI DI MODULI ТИПЫ МОДУЛЕЙ	<input checked="" type="checkbox"/> Compact Compatto Компактная	<input type="checkbox"/> Modular Modulare Модульная	
<b>POSITION</b> POSIZIONE ПОЗИЦИЯ	<input checked="" type="checkbox"/> Wall-mounted Sospeso Подвесная	<input type="checkbox"/> Floor-mounted A terra Напольная	
<b>MEASURES (CM)</b> DIMENSIONI РАЗМЕРЫ	◀ 60 / 90 / 120 23 <sup>5/8</sup> / 35 <sup>3/8</sup> / 47 <sup>1/4</sup>	▲ 20 / 26 7 <sup>7/8</sup> / 10 <sup>1/4</sup>	↘ 52 / 47 20 <sup>1/2</sup> / 18 <sup>1/2</sup>
<b>WORKTOP &amp; BASIN OPTIONS</b> OPZIONI TOP E LAVABI ВАРИАНТЫ СТОЛЕШНИЦ И УМЫВАЛЬНЫХ РАКОВИН	<input checked="" type="checkbox"/> Bath serie's worktop / basin Lavabo / top della serie Серийная умывальная раковина / столешница	<input type="checkbox"/> Standard worktops Top standard Стандартные столешницы	<input type="checkbox"/> Worktop + integrated basin Encimera + lavabo integrato Столешница + встроенная умывальная раковина
	<input checked="" type="checkbox"/> Over-mounted basin Lavabo da appoggio Настольная умывальная раковина	<input type="checkbox"/> Under-mounted basin Lavabo sottopiano Умывальная раковина, встраиваемая в столешницу снизу	<input type="checkbox"/> Double basin as option Opzione doppia vasca Вариант с двойной чашей
<b>WORKTOP FINISHES</b> FINITURE TOP ОТДЕЛКА СТОЛЕШНИЦ	<input type="checkbox"/> Krion® worktop Top in KRION® Столешница KRION®	<input type="checkbox"/> Gel Coat worktop Top in Gel Coat Столешница с покрытием гелькоут	<input type="checkbox"/> Natural Stone worktop Top in pietra naturale Столешница из натурального камня.
	<input type="checkbox"/> Glass worktop Top in vetro Столешница из стекла	<input type="checkbox"/> Bath furniture finish worktop Top con la finitura del mobile Столешница с той же отделкой, что и консоль/тумба	
<b>BASIN FINISHES</b> FINITURE LAVABI ОТДЕЛКА УМЫВАЛЬНЫХ РАКОВИН	<input type="checkbox"/> Krion® basin Lavabo in Krion® Умывальная раковина из Krion®	<input type="checkbox"/> Gel Coat basin Lavabo Gelcoat Раковина Gelcoat	<input type="checkbox"/> Ceramic basin Lavabo in ceramica Керамическая умывальная раковина
	<input checked="" type="checkbox"/> Natural Stone basin Lavabo in pietra naturale Умывальная раковина из натурального камня.		
<b>ACCESSORIES</b> ACCESSORI АКСЕССУАРЫ	<input checked="" type="checkbox"/> Mirror Specchio Зеркало	<input checked="" type="checkbox"/> Wall-mounted module Modulo sospeso Подвесной модуль	<input type="checkbox"/> Tall cabinet Modulo colonna Высокий шкаф
	<input type="checkbox"/> Upper unit Modulo alto Верхний модуль	<input type="checkbox"/> Organizer Organizzatore Органайзер	<input checked="" type="checkbox"/> Shelves Mensola Полка
			<input type="checkbox"/> Accessories Accessori Аксессуары

# duna



duna

A basin unit made up of an aluminium sheet, curved to form raised sides, into which a granite washbasin has been fitted. This has been shaped using “folding” technology to fit neatly into the curved sheet of metal and ensure a continuous veined granite pattern. Aluminium, lacquered with black epoxy paint, and Portobello granite were chosen as the finishes for the unit.

Accompanying it is a wall-hung unit with a drawer, covered in a rustic-look natural oak veneer.

The series is rounded off with a matching round mirror with an aluminium frame, featuring a shelf that rests inside the frame and integrated lighting.

Insieme composto da una lamiera in alluminio dalla forma a canale e da un lavabo in granito naturale realizzato con la tecnologia “Folding” per poterlo inserire nel vano della lamiera curva e mettere in rilievo la venatura del materiale.

Per questo insieme sono state selezionate le finiture laccate con vernice epossidica in nero per l’alluminio e Portobello per il granito.

Il modulo ausiliario che completa questa serie è un modulo sospeso con un cassetto, realizzato in impiallacciato di rovere naturale effetto rustico.

Questa serie si completa con uno specchio rotondo coordinato al resto dell’arredo, con un ripiano appoggiato all’interno della cornice in alluminio e l’illuminazione integrata nello specchio.

Комплект состоит из алюминиевого листа в форме канала и присоединенной к нему умывальной раковины, изготовленной из натурального гранита с использованием технологии фолдинга. Эта технология позволяет адаптировать раковину к внутренней поверхности изогнутого листа и сохранить сплошной рисунок прожилок.

Для этого комплекта были выбраны такие виды отделки, как алюминий, лакированный черной эпоксидной краской, и гранит Портобелло.

Серия имеет дополнительный подвесной модуль с одним ящиком, изготовленный из натурального дубового шпона в стиле рустик.

Завершает серию зеркало в круглой алюминиевой раме, подходящее по тону к остальным изделиям. Внутри рамы имеется полка, а кроме того, в зеркало встроен светильник.



+info p.384

# highline



duna



**8283 Points**  
**DUNA roble noche**

**FINISHES**

**WOOD**

**LEGNO**

**ДЕРЕВО**



Roble Noche R.



Roble Cobre R.



Roble Bronce R.

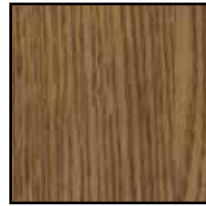

Roble Sil R.



Roble Alba R.



Roble Carbón R.



Roble Cuero R.



Roble Polvo R.



Roble Puro R.



**GLOSS LACQUER / MATT LACQUER**

**LACCATO LUCIDO / LACCATO OPACO**

**ГЛЯНЦЕВЫЙ ЛАК / МАТОВЫЙ ЛАК**



Ónix



Cromo

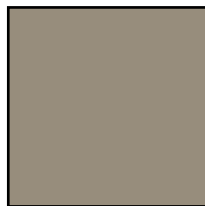

Féreo



Tórtola



Sílice

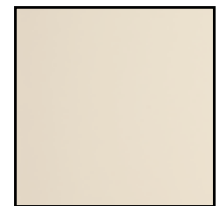

Bórax

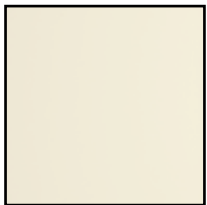

Cuarcita



Pizarra

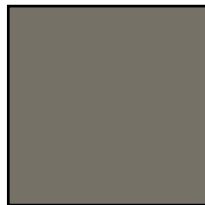

Grafito

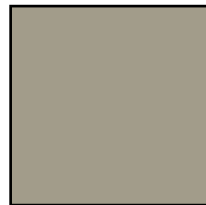

Plomo

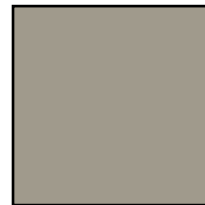

Limo

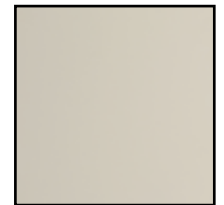

Pérgamon

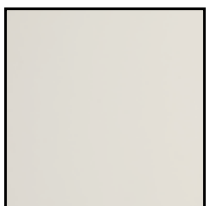

Alabastro

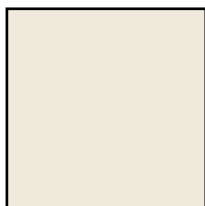

Porcelana

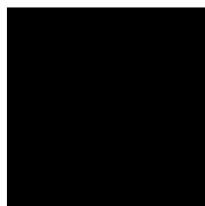

Negro Emotions



Ocean Blue



Azul Navy

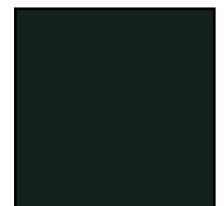

Bottle

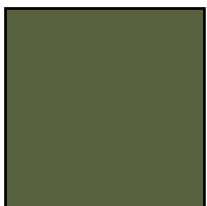

Orégano



Cúrcuma



Safrán



Curry

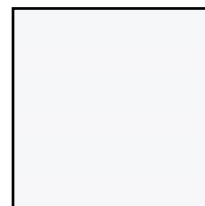

Blanco Snow

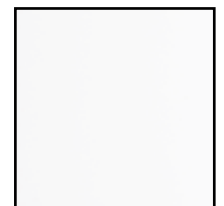

Blanco Emotions



## FINISHES

### WORKTOPS

### TOP

### СТОЛЕШНИЦЫ

Ⓐ



Via  
Lactea



Mármol  
Carrara



Granito  
Portobello

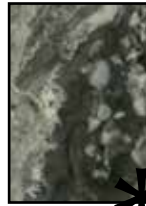

Arabescato  
Orobico



G. Negro  
Tanzania M.



Granito Len



Barocco  
Vintage



Cheyenne  
Vintage



Amarula  
Vintage

### XTONE



Glem White



Paonazzo  
Biondo P.



Bottega  
Acero



Invisible  
White Pulido

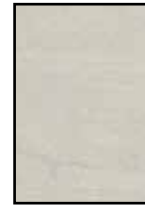

Aged Clay



Liem Grey  
Nature



Aged Dark



Bottega  
Antracita



Liem Dark  
Nature

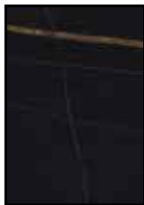

Nylo Noir  
Pulido

## WASH BASIN UNIT 90 DX

DEPTH 52CM / 20<sup>1/2</sup>"

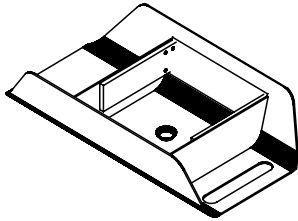

Wash basin unit.

Basi portlavabo

Тумбочка под умывальник.

MEASURES	FINISHES	SAP	POINTS
90x20x52 / 35 <sup>3/8</sup> x7 <sup>7/8</sup> x20 <sup>1/2</sup>	Metal	100190977	1386

## WASH BASIN UNIT 120 DX

DEPTH 52CM / 20<sup>1/2</sup>"

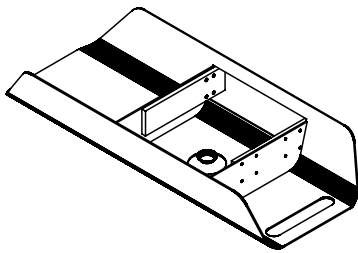

Wash basin unit.

Basi portlavabo

Тумбочка под умывальник.

BP MEASURES	FINISHES	SAP	POINTS
120x20x52 / 47 <sup>1/4</sup> x7 <sup>7/8</sup> x20 <sup>1/2</sup>	Metal	100190985	1655

## DUNA BASIN

DEPTH 47CM / 18<sup>1/2</sup>"

### FINISHES:

- G-1: ④ Via Lactea, Mármol Carrara.
- G-2: Granito Len, Granito Tanzania Mate.
- G-3: Barocco Vintage, Cheyenne Vintage, Arabescato Orobico.
- G-4: Amarula Vintage, Granito Portobello.



Without tap hole



Tap hole DX



Tap hole SX

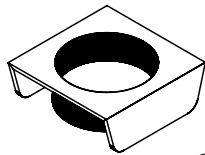

-Basin.

-It requires valve (100104178 / 59 Points).

-It requires drainage (100190984 / 210 Points).

-Lavabo.

-Richiede valvola (100104178 / 59 punti).

-Richiede scarico (100190984 / 210 Points).

-Раковина.

-Требуется постоянный перелив (100104178 / 59 позиций).

-Требуется дренаж (100190984 / 210 Points).

MEASURES	FINISHES	SAP	POINTS
47x17x47 / 18 <sup>1/2</sup> x6 <sup>3/4</sup> x18 <sup>1/2</sup>	G1	700030001	2062
	G2	700029981	2219
	G3	700019700	2399
	G4	700019859	2600

## DUNA XTONE BASIN

DEPTH 47CM / 18 1/2"

### FINISHES:

**XTONE G-2: Bottega Acero / Aged Clay / Aged Dark / Bottega Antracita.**

**XTONE G-3: Liem Grey Nature / Liem Dark Nature.**

**XTONE G-4: Glem White / Paonazzo Biondo Pulido / Invisible White Pulido / Nylo Noir Pulido.**

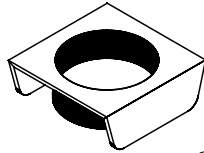

-Basin.  
-It requires valve (100104178 / 59 Points).  
-It requires drainage (100190984 / 210 Points).

-Lavabo.  
-Richiede valvola (100104178 / 59 punti).  
-Richiede scarico (100190984 / 210 Points).

-Раковина.  
-Требуется постоянный перелив (100104178 / 59 позиций).  
-Требуется дренаж (100190984 / 210 Points).

MEASURES	( x  x )	FINISHES	SAP	POINTS
		XTONE G2	700031486	1972
		XTONE G3	700031109	2017
		XTONE G4	700031487	2062

### DRAINAGE



-Drainage.  
-Scarico.  
-Дренаж.

FINISHES	SAP	POINTS
Chrome	100190984	210
Black matt lacquer	100242315	255

## FREESTANDING UNIT

DEPTH 47CM / 18<sup>1/2</sup>"

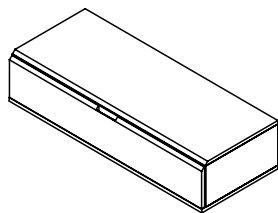

Wallmounted unit.

Modulo sospeso

Тумба для ванной, монтируемая на стену.

MEASURES		FINISHES	SAP	POINTS
60x26x47 / 23 <sup>5/8</sup> x10 <sup>1/4</sup> x18 <sup>1/2</sup>		Gloss lacquer	700019710	1489
		Matt lacquer	700019707	1337
		Wood	700019704	1952
90x26x47 / 35 <sup>3/8</sup> x10 <sup>1/4</sup> x18 <sup>1/2</sup>		Gloss lacquer	700019711	1712
		Matt lacquer	700019708	1526
		Wood	700019705	2269
MS 120x26x47 / 47 <sup>1/4</sup> x10 <sup>1/4</sup> x18 <sup>1/2</sup>		Gloss lacquer	700019712	1951
		Matt lacquer	700019709	1729
		Wood	700019706	2566

## MIRROR

DEPTH 10CM / 3<sup>7/8</sup>"

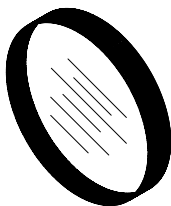

Mirror.

Specchio

Зеркало.

MEASURES		FINISHES	SAP	POINTS
61x61x10 / 24x24x3 <sup>7/8</sup>		Metal	700019701	637

## MIRROR WITH LIGHT 220V

DEPTH 10CM / 3<sup>7/8</sup>"

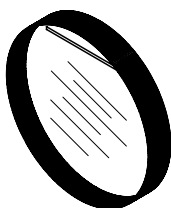

Mirror with light.

Specchio

Зеркало.

N/A USA.

MEASURES		FINISHES	SAP	POINTS
61x61x10 / 24x24x3 <sup>7/8</sup>		Metal	700019702	1098

## SHELF / MIRROR

DEPTH 6,5CM / 2<sup>1/2</sup>"

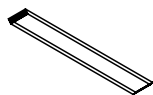

Shelf.

Ripiano.

Полка.

MEASURES		FINISHES	SAP	POINTS
49x1,2x6,5 / 19 <sup>1/4</sup> x0 <sup>1/2</sup> x2 <sup>1/2</sup>		Krion	700019703	154

# highline

duna



The interpretation made in inches for the dimensions of the different items shown in the price list has been rounded to 1/8, however for a more accurate measurement please use millimetres or centimetres.

## Century

<b>EXTERIOR FINISHES</b> FINITURE ESTERNE ОТДЕЛКА ДЛЯ НАРУЖНОГО ИСПОЛЬЗОВАНИЯ	<input type="checkbox"/> Laminate Laminato ЛАМИНАТ	<input checked="" type="checkbox"/> Matt lacquer Laccato opaco МАТОВЫЙ ЛАК	<input checked="" type="checkbox"/> Wood veneer Legno ДЕРЕВО
	<input type="checkbox"/> HPL Stratificato СЛОИСТАЯ	<input checked="" type="checkbox"/> Gloss lacquer Laccato lucido ГЛЯНЦЕВЫЙ ЛАК	
<b>INTERIOR FINISHES</b> FINITURE INTERNE ОТДЕЛКА ДЛЯ ВНУТРЕННЕГО ИСПОЛЬЗОВАНИЯ	<input type="checkbox"/> Laminate Laminato ЛАМИНАТ	<input type="checkbox"/> Wood veneer Legno ДЕРЕВО	<input checked="" type="checkbox"/> Aluminium+laminated base Alluminio + base in laminato Алюминий + основа из ламината
	<input checked="" type="checkbox"/> Front handle Maniglia frontale a vista Декоративная передняя ручка	<input type="checkbox"/> Integrated metal handle Maniglia metallica integrata Встроенная металлическая ручка	<input type="checkbox"/> Integrated mechanized h. Maniglia integrata ricavata sul bordo Встроенная ручка по краю
<b>HANDLES</b> MANIGLIE РУЧКИ	<input type="checkbox"/> Push handle Maniglia Push РУЧКИ Push		
<b>TYPE OF UNITS</b> TIPI DI MODULI ТИПЫ МОДУЛЕЙ	<input checked="" type="checkbox"/> Compact Compatto Компактная	<input type="checkbox"/> Modular Modulare Модульная	
<b>POSITION</b> POSIZIONE ПОЗИЦИЯ	<input checked="" type="checkbox"/> Wall-mounted Sospeso Подвесная	<input type="checkbox"/> Floor-mounted A terra Напольная	
<b>MEASURES (CM)</b> DIMENSIONI РАЗМЕРЫ	◀ 64 / 94 / 124 / 184	▲ 55	↙ 48
	25 <sup>1/4</sup> / 37 / 48 <sup>7/8</sup> / 72 <sup>1/2</sup>	21 <sup>5/8</sup>	18 <sup>7/8</sup>
<b>WORKTOP &amp; BASIN OPTIONS</b> OPZIONI TOP E LAVABI ВАРИАНТЫ СТОЛЕШНИЦ И УМЫВАЛЬНЫХ РАКОВИН	<input checked="" type="checkbox"/> Bath serie's worktop / basin Lavabo / top della serie Серийная умывальная раковина / столешница	<input type="checkbox"/> Standard worktops Top standard Стандартные столешницы	<input type="checkbox"/> Worktop + integrated basin Encimera + lavabo integrato Столешница + встроенная умывальная раковина
	<input type="checkbox"/> Over-mounted basin Lavabo da appoggio Настольная умывальная раковина	<input checked="" type="checkbox"/> Under-mounted basin Lavabo sottopiano Умывальная раковина, встраиваемая в столешницу снизу	<input type="checkbox"/> Double basin as option Opzione doppia vasca Вариант с двойной чашей
<b>WORKTOP FINISHES</b> FINITURE TOP ОТДЕЛКА СТОЛЕШНИЦ	<input type="checkbox"/> Krion® worktop Top in KRION® Столешница KRION®	<input type="checkbox"/> Gel Coat worktop Top in Gel Coat Столешница с покрытием гелькоут	<input checked="" type="checkbox"/> Natural Stone worktop Top in pietra naturale Столешница из натурального камня.
	<input type="checkbox"/> Glass worktop Top in vetro Столешница из стекла	<input type="checkbox"/> Bath furniture finish worktop Top con la finitura del mobile Столешница с той же отделкой, что и консоль/тумба	
<b>BASIN FINISHES</b> FINITURE LAVABI ОТДЕЛКА УМЫВАЛЬНЫХ РАКОВИН	<input type="checkbox"/> Krion® basin Lavabo in Krion® Умывальная раковина из Krion®	<input type="checkbox"/> Gel Coat basin Lavabo Gelcoat Раковина Gelcoat	<input checked="" type="checkbox"/> Ceramic basin Lavabo in ceramica Керамическая умывальная раковина
	<input type="checkbox"/> Natural Stone basin Lavabo in pietra naturale Умывальная раковина из натурального камня.		
<b>ACCESSORIES</b> ACCESSORI АКСЕССУАРЫ	<input checked="" type="checkbox"/> Mirror Specchio Зеркало	<input type="checkbox"/> Wall-mounted module Modulo sospeso Подвесной модуль	<input type="checkbox"/> Tall cabinet Modulo colonna Высокий шкаф
	<input type="checkbox"/> Upper unit Modulo alto Верхний модуль	<input type="checkbox"/> Organizer Organizzatore Органайзер	<input type="checkbox"/> Shelves Mensola Полка
			<input type="checkbox"/> Accessories Accessori Аксессуары

# century



A washbasin unit with a carved oak veneer finish to give it a rustic appearance.

This is a compact unit, featuring two drawers with a Metal laminate lining and Nadir texture. Visually it stands out for two reasons: firstly, for its slightly sunken fronts, with a linear metal handle that juts out so that it is flush with the sides and countertop; and, secondly, because its side panels and wood veneer base are assembled to each other and to the countertop with mitre joints to create a solid ensemble.

The stone countertop can come with an undermount washbasin (the Sotto Box model) or one made of stone.

Accompanying it is a mirror with a frame in a glossy chrome finish.

Mobile da bagno prodotto in impiallacciato di rovere naturale lavorato, che conferisce un effetto rustico. Si tratta di un mobile compatto con due cassetti e finitura interna in laminato Metal con texture Nadir. Il mobile è caratterizzato da due aspetti. Da un lato, i frontali leggermente rientranti e la maniglia realizzata con l'asta orizzontale metallica che sporge dai frontali per andare a filo con le fiancate e il top. Dall'altro, i pannelli laterali e la base in impiallacciato di legno sono uniti tra di loro e al top tramite tagli angolati, ottenendo così un unico blocco continuo. Il top è in pietra naturale e vi si può inserire un lavabo sottopiano in ceramica (Sotto Box) o realizzato nella stessa pietra naturale. La composizione è corredata dallo specchio dalla cornice con finitura cromata lucida.

Консоль для ванной комнаты, изготовленная из обработанного натурального дубового шпона, который придает композиции эффект стиля рустик.

Компактная консоль имеет два ящика с внутренней отделкой из ламината Metal с текстурой Nadir. Внешне эта консоль отличается двумя основными характеристиками. Во-первых, ее передние панели слегка утоплены, а в качестве ручки служит горизонтальная металлическая линия, которая выступает из этих панелей, достигая уровня боковых частей и столешницы. Во-вторых, боковые панели и основа из деревянного шпона соединяются под углом между собой и со столешницей, образуя единый сплошной блок.

Столешница сделана из натурального камня и может включать встраиваемую снизу умывальную раковину: керамическую (Sotto Box) или изготовленную из того же натурального камня.

Композиция дополняется зеркалом в раме с блестящей хромированной отделкой.



+info p.384



# highline

century



**4016 Points**  
**CENTURY Roble Polvo**

**FINISHES**

**WOOD**

**LEGNO**

**ДЕРЕВО**



Roble Noche R.



Roble Cobre R.



Roble Bronce R.

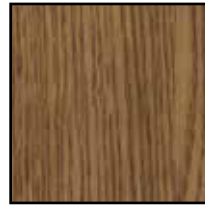

Roble Sil R.



Roble Alba R.



Roble Carbón R.

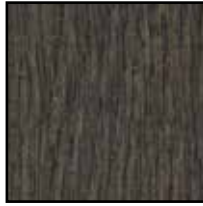

Roble Cuero R.



Roble Polvo R.



Roble Puro R.



**GLOSS LACQUER**

**LACCATO LUCIDO**

**ГЛЯНЦЕВЫЙ ЛАК**



Ónix



Cromo

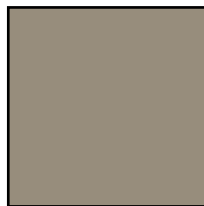

Férreo



Tórtola



Sílice

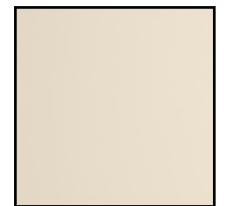

Bórax

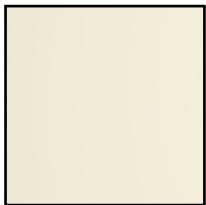

Cuarcita



Pizarra

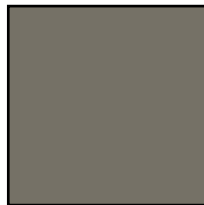

Grafito

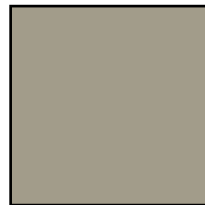

Plomo

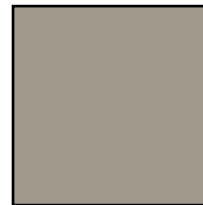

Limo

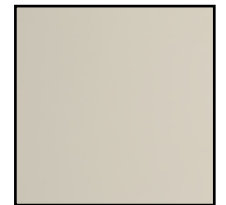

Pérgamon

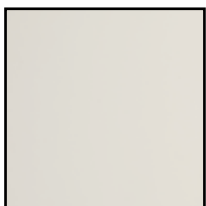

Alabastro



Porcelana

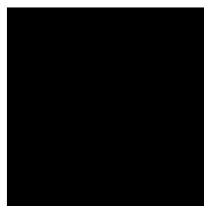

Negro Emotions



Ocean Blue



Azul Navy

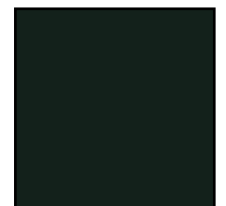

Bottle

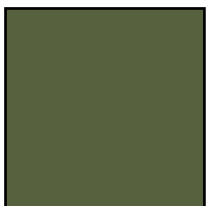

Orégano



Cúrcuma



Safrán



Curry

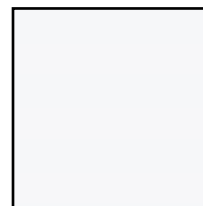

Blanco Snow

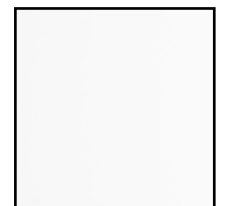

Blanco Emotions

## FINISHES

MATT LACQUER

LACCATO OPACO

МАТОВЫЙ ЛАК



Ónix



Cromo

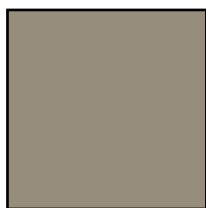

Férreo



Tórtola



Sílice



Bórax

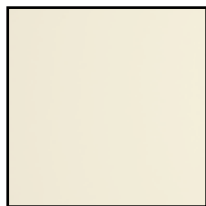

Cuarcita



Pizarra



Grafito

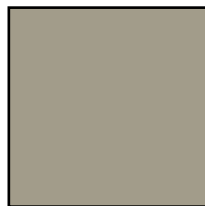

Plomo

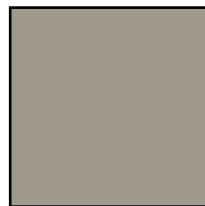

Limo



Pérgamon



Alabastro

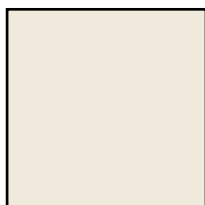

Porcelana

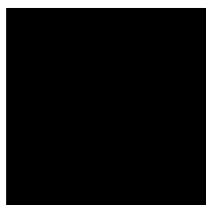

Negro Emotions



Ocean Blue



Azul Navy



Bottle



Orégano



Cúrcuma



Safrán



Curry

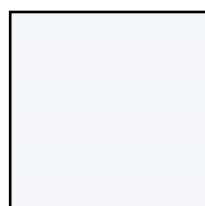

Blanco Snow

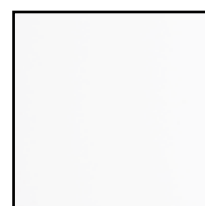

Blanco Emotions

WORKTOPS

TOP

СТОЛЕШНИЦЫ



Mármol  
Carrara



Barocco  
Vintage



Cheyenne  
Vintage



Amarula  
Vintage

## WASH BASIN UNIT

DEPTH 48CM / 18<sup>7/8</sup>"

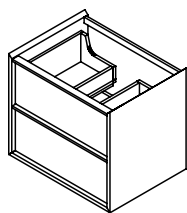

- Wash basin unit.
- Base portalavabo
- Тумбочка под умывальник.



MEASURES	(xx)	FINISHES	SAP	POINTS
64x55x48 / 25 <sup>1/4</sup> x21 <sup>5/8</sup> x18 <sup>7/8</sup>		Gloss lacquer	700025980	2017
		Matt lacquer	700025971	1938
		Wood	700019851	2461
94x55x48 / 37x21 <sup>5/8</sup> x18 <sup>7/8</sup>		Gloss lacquer	700025961	2242
		Matt lacquer	700025951	2149
		Wood	700019860	2772
124x55x48 / 48 <sup>7/8</sup> x21 <sup>5/8</sup> x18 <sup>7/8</sup>		Gloss lacquer	700025940	2570
		Matt lacquer	700025950	2464
		Wood	700019840	3070

## WASH BASIN UNIT

DEPTH 48CM / 18<sup>7/8</sup>"

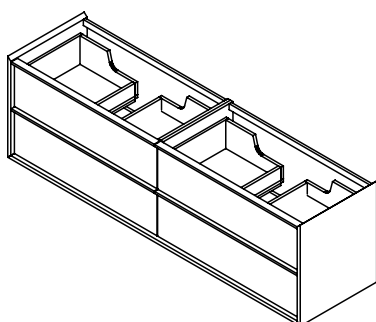

- Wash basin unit.
- Base portalavabo
- Тумбочка под умывальник.



MEASURES	(xx)	FINISHES	SAP	POINTS
184x55x48 / 72 <sup>1/2</sup> x21 <sup>5/8</sup> x18 <sup>7/8</sup>		Gloss lacquer	700025960	3939
		Matt lacquer	700025970	3802
		Wood	700019850	4619

## WORKTOP

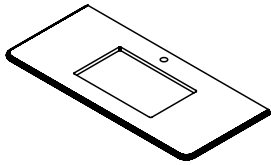

- Worktop.
- Топ.
- Столешница.

MEASURES		FINISHES	SAP	POINTS
64x2x48,5 / 25 <sup>1/4</sup> x0 <sup>3/4</sup> x19 <sup>1/8</sup>		Mármol Carrara	700002508	637
		Barocco Vintage		866
		Cheyenne Vintage		866
		Amarula Vintage		1009
94x2x48,5 / 37x0 <sup>3/4</sup> x19 <sup>1/8</sup>		Mármol Carrara	700002508	722
		Barocco Vintage		1058
		Cheyenne Vintage		1058
		Amarula Vintage		1268
124x2x48,5 / 48 <sup>7/8</sup> x0 <sup>3/4</sup> x19 <sup>1/8</sup>		Mármol Carrara	700002508	813
		Barocco Vintage		1256
		Cheyenne Vintage		1256
		Amarula Vintage		1533
184x2x48,5 / 72 <sup>1/2</sup> x0 <sup>3/4</sup> x19 <sup>1/8</sup>		Mármol Carrara	700002508	1098
		Barocco Vintage		1755
		Cheyenne Vintage		1755
		Amarula Vintage		2166

## SOTTO NOVA RECESSED SINK

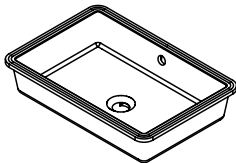

- Ceramic basin. **REQUIRES WORKTOP.**
- Lavabo in ceramica. **RICHIEDE TOP.**
- Керамическая раковина. **НУЖДАЕТСЯ В СТОЛЕШНИЦЕ.**

MEASURES		FINISHES	SAP	POINTS
50x14,2x34 / 19 <sup>5/8</sup> x5 <sup>5/8</sup> x13 <sup>3/8</sup>		White ceramic	100241696	253
62x14,2x34 / 24 <sup>3/8</sup> x5 <sup>5/8</sup> x13 <sup>3/8</sup>			100286592	370

## SLIM BASIN COUNTERTOP / SOBRE ENCIMERA / VASQUE SUR PLAN REQUIRES WORKTOP

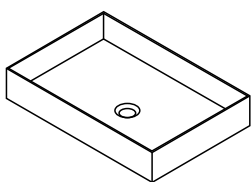

- GELCOAT basin. **REQUIRES WORKTOP.**
- Requires for installation valve SAP100036254, 68 P.
- Lavabo GELCOAT. **RICHIEDE TOP IN.**
- Richiede valvola SAP100036254, 68 P.
- Раковина GELCOAT. **НУЖДАЕТСЯ В СТОЛЕШНИЦЕ.**
- Требуется установка клапана SAP100036254, 68 P.

MEASURES		FINISHES	SAP	POINTS
50x10x33 / 19 <sup>5/8</sup> x3 <sup>7/8</sup> x13		GELCOAT	100221198	475



The interpretation made in inches for the dimensions of the different items shown in the price list has been rounded to 1/8, however for a more accurate measurement please use millimetres or centimetres.

## Edge

<b>EXTERIOR FINISHES</b> FINITURE ESTERNE ОТДЕЛКА ДЛЯ НАРУЖНОГО ИСПОЛЬЗОВАНИЯ	<input type="checkbox"/> Laminate Laminato ЛАМИНАТ	<input type="checkbox"/> Matt lacquer Laccato opaco МАТОВЫЙ ЛАК	<input checked="" type="checkbox"/> Wood veneer Legno ДЕРЕВО
	<input type="checkbox"/> HPL Stratificato СЛОИСТАЯ	<input type="checkbox"/> Gloss lacquer Laccato lucido ГЛЯНЦЕВЫЙ ЛАК	
<b>INTERIOR FINISHES</b> FINITURE INTERNE ОТДЕЛКА ДЛЯ ВНУТРЕННЕГО ИСПОЛЬЗОВАНИЯ	<input type="checkbox"/> Laminate Laminato ЛАМИНАТ	<input type="checkbox"/> Wood veneer Legno ДЕРЕВО	<input checked="" type="checkbox"/> Aluminium+laminated base Alluminio + base in laminato Алюминий + основа из ламината
<b>HANDLES</b> MANIGLIE РУЧКИ	<input type="checkbox"/> Front handle Maniglia frontale a vista Декоративная передняя ручка	<input type="checkbox"/> Integrated metal handle Maniglia metallica integrata Встроенная металлическая ручка	<input type="checkbox"/> Integrated mechanized h. Maniglia integrata ricavata sul bordo Встроенная ручка по краю
	<input checked="" type="checkbox"/> Push handle Maniglia Push РУЧКИ Push		
<b>TYPE OF UNITS</b> TIPI DI MODULI ТИПЫ МОДУЛЕЙ	<input checked="" type="checkbox"/> Compact Compatto Компактная	<input type="checkbox"/> Modular Modulare Модульная	
<b>POSITION</b> POSIZIONE ПОЗИЦИЯ	<input checked="" type="checkbox"/> Wall-mounted Sospeso Подвесная	<input type="checkbox"/> Floor-mounted A terra Напольная	
<b>MEASURES (CM)</b> DIMENSIONI РАЗМЕРЫ	◀ 60 / 90 / 120 23 <sup>5/8</sup> / 35 <sup>3/8</sup> / 47 <sup>1/4</sup>	▲ 48 18 <sup>7/8</sup>	◀ 48 18 <sup>7/8</sup>
<b>WORKTOP &amp; BASIN OPTIONS</b> OPZIONI TOP E LAVABI ВАРИАНТЫ СТОЛЕШНИЦ И УМЫВАЛЬНЫХ РАКОВИН	<input checked="" type="checkbox"/> Bath serie's worktop / basin Lavabo / top della serie Серийная умывальная раковина / столешница	<input type="checkbox"/> Standard worktops Top standard Стандартные столешницы	<input type="checkbox"/> Worktop + integrated basin Encimera + lavabo integrato Столешница + встроенная умывальная раковина
	<input checked="" type="checkbox"/> Over-mounted basin Lavabo da appoggio Настольная умывальная раковина	<input type="checkbox"/> Under-mounted basin Lavabo sottopiano Умывальная раковина, встраиваемая в столешницу снизу	<input type="checkbox"/> Double basin as option Opzione doppia vasca Вариант с двойной чашей
<b>WORKTOP FINISHES</b> FINITURE TOP ОТДЕЛКА СТОЛЕШНИЦ	<input type="checkbox"/> Krion® worktop Top in KRION® Столешница KRION®	<input type="checkbox"/> Gel Coat worktop Top in Gel Coat Столешница с покрытием гелькоут	<input type="checkbox"/> Natural Stone worktop Top in pietra naturale Столешница из натурального камня.
	<input type="checkbox"/> Glass worktop Top in vetro Столешница из стекла	<input type="checkbox"/> Bath furniture finish worktop Top con la finitura del mobile Столешница с той же отделкой, что и консоль/тумба	
<b>BASIN FINISHES</b> FINITURE LAVABI ОТДЕЛКА УМЫВАЛЬНЫХ РАКОВИН	<input type="checkbox"/> Krion® basin Lavabo in Krion® Умывальная раковина из Krion®	<input type="checkbox"/> Gel Coat basin Lavabo Gelcoat Раковина Gelcoat	<input type="checkbox"/> Ceramic basin Lavabo in ceramica Керамическая умывальная раковина
	<input checked="" type="checkbox"/> Natural Stone basin Lavabo in pietra naturale Умывальная раковина из натурального камня.		
<b>ACCESSORIES</b> ACCESSORI АКСЕССУАРЫ	<input checked="" type="checkbox"/> Mirror Specchio Зеркало	<input type="checkbox"/> Wall-mounted module Modulo sospeso Подвесной модуль	<input type="checkbox"/> Tall cabinet Modulo colonna Высокий шкаф
	<input type="checkbox"/> Upper unit Modulo alto Верхний модуль	<input type="checkbox"/> Organizer Organizzatore Органайзер	<input type="checkbox"/> Shelves Mensola Полка
			<input type="checkbox"/> Accessories Accessori Аксессуары

## edge



A washbasin unit made up of an outer tubular aluminium framework in a Metal finish. This holds a stone washbasin and carved wood veneer unit. This combination of carved wood and stone gives it a Vintage appearance.

There are three possible options in this series: a washbasin unit featuring two drawers, one with a top drawer and a lower shelf, and a third with a shelf at the bottom. It also comes in four different widths: 60, 90 and 120.

The drawers have a Metal laminate lining and Nadir texture.

Rounding it all off is a mirror with the same aluminium surround as the frame of the washbasin unit.

Mobile di bagno composto da una struttura esterna con profilo in alluminio a sezione quadrata con finitura Metal, che ospita il lavabo prodotto in pietra naturale e il mobile, in impiallacciato in legno naturale lavorato. Con l'abbinamento del legno lavorato e della pietra naturale si ottiene un aspetto vintage. Questa serie presenta tre versioni di mobile: con due cassetti oppure con cassetto superiore e ripiano nella parte inferiore e infine con un ripiano nella parte inferiore. Sono disponibili quattro misure da 60, 90 e 120. L'interno del cassetto presenta la finitura in laminato Metal con texture Nadir. La composizione è completata dagli specchi con la cornice realizzata con lo stesso profilo in alluminio che caratterizza il mobile.

Консоль для ванной комнаты включает наружную конструкцию с алюминиевым профилем квадратного сечения, с отделкой Metal, а также встроенную умывальную раковину из натурального камня и компоненты из обработанного натурального деревянного шпона. Такая комбинация обработанного дерева и натурального камня придает всей композиции винтажный вид.

Эта серия допускает три возможных варианта на выбор: один с двумя ящиками, другой с верхним ящиком и полкой в нижней части, третий с полкой в нижней части. Кроме того, имеется четыре размера по ширине: 60, 90 и 120 см.

Внутри ящик отделан ламинатом Metal с текстурой Nadir.

Композиция дополнена зеркалами, рама для которых изготавливается из того же алюминиевого профиля, характерного для всей композиции.



+info p.384



# highline



edge



6753 Points  
EDGE Roble Cuero

**FINISHES**

WOOD

LEGNO

ДЕРЕВО



Roble Noche R.



Roble Cobre R.



Roble Bronce R.

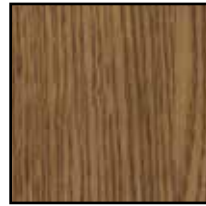

Roble Sil R.



Roble Alba R.



Roble Carbón R.



Roble Cuero R.



Roble Polvo R.



Roble Puro R.



WORKTOPS

TOP

СТОЛЕШНИЦЫ



Via  
Lactea



Mármol  
Carrara



G. Negro  
Tanzania M.



Granito Len



Barocco  
Vintage



Cheyenne  
Vintage



Amarula  
Vintage

## WASH BASIN UNIT BPS-2

DEPTH 48CM / 18<sup>7</sup>/<sub>8</sub>"

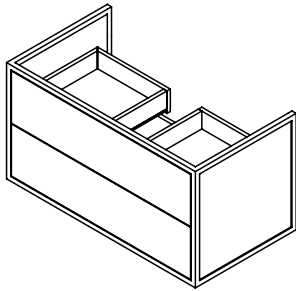

- Wash basin unit.
- Base portalavabo
- Тумбочка под умывальник.

MEASURES	(  x  x  )	FINISHES	SAP	POINTS
60x48x48	/ 23 <sup>5</sup> / <sub>8</sub> x18 <sup>7</sup> / <sub>8</sub> x18 <sup>7</sup> / <sub>8</sub>	Wood	700019863	3459
90x48x48	/ 35 <sup>3</sup> / <sub>8</sub> x18 <sup>7</sup> / <sub>8</sub> x18 <sup>7</sup> / <sub>8</sub>		700019845	3767
120x48x48	/ 47 <sup>1</sup> / <sub>4</sub> x18 <sup>7</sup> / <sub>8</sub> x18 <sup>7</sup> / <sub>8</sub>		700019843	4042

## WASH BASIN UNIT BPS-1 H

DEPTH 48CM / 18<sup>7</sup>/<sub>8</sub>"

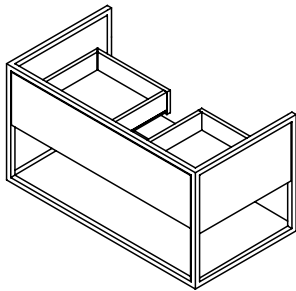

- Wash basin unit.
- Base portalavabo
- Тумбочка под умывальник.



MEASURES	(  x  x  )	FINISHES	SAP	POINTS
60x48x48	/ 23 <sup>5</sup> / <sub>8</sub> x18 <sup>7</sup> / <sub>8</sub> x18 <sup>7</sup> / <sub>8</sub>	Wood	700019871	2856
90x48x48	/ 35 <sup>3</sup> / <sub>8</sub> x18 <sup>7</sup> / <sub>8</sub> x18 <sup>7</sup> / <sub>8</sub>		700019855	3166
120x48x48	/ 47 <sup>1</sup> / <sub>4</sub> x18 <sup>7</sup> / <sub>8</sub> x18 <sup>7</sup> / <sub>8</sub>		700019854	3448

## WASH BASIN UNIT BPS H

DEPTH 48CM / 18<sup>7</sup>/<sub>8</sub>"

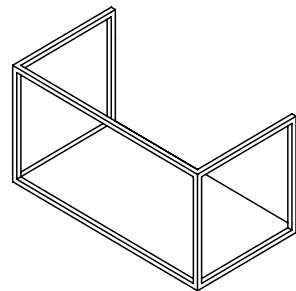

- Wash basin unit.
- Base portalavabo
- Тумбочка под умывальник.



MEASURES	(  x  x  )	FINISHES	SAP	POINTS
60x48x48	/ 23 <sup>5</sup> / <sub>8</sub> x18 <sup>7</sup> / <sub>8</sub> x18 <sup>7</sup> / <sub>8</sub>	Wood	700019844	1574
90x48x48	/ 35 <sup>3</sup> / <sub>8</sub> x18 <sup>7</sup> / <sub>8</sub> x18 <sup>7</sup> / <sub>8</sub>		700019872	1805
120x48x48	/ 47 <sup>1</sup> / <sub>4</sub> x18 <sup>7</sup> / <sub>8</sub> x18 <sup>7</sup> / <sub>8</sub>		700019862	2021

## FINISHES:

- G-1: Ⓐ Via Lactea, Mármol Carrara.  
 G-2: Granito Len, Granito Tanzania Mate.  
 G-3: Barocco Vintage, Cheyenne Vintage.  
 G-4: Amarula Vintage.

## BASIN

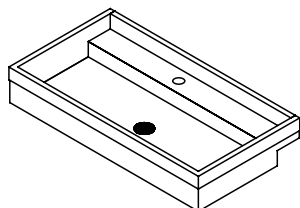

- Basin.
- Requires permanent valve SAP100036254, 68 P.
- Lavabo.
- Richiede valvola semplice di scarico libero con tappo coprivalvola SAP100036254, 68 P.
- Раковина.
- Требуется постоянный клапан SAP100036254, 68 P.

MEASURES	()	BPS	FINISHES	SAP	POINTS
56x14x46 / 22x5 <sup>1/2</sup> x18 <sup>1/8</sup>		60/23 <sup>5/8</sup>	G.1	700023601	1897
			G.2	700023611	2121
			G.3	700023612	2295
			G.4	700023603	2545
86x14x46 / 33 <sup>7/8</sup> x5 <sup>1/2</sup> x18 <sup>1/8</sup>		90/35 <sup>3/8</sup>	G.1	700023605	2066
			G.2	700023592	2384
			G.3	700023594	2632
			G.4	700023581	2986
116x14x46 / 45 <sup>5/8</sup> x5 <sup>1/2</sup> x18 <sup>1/8</sup>		120/47 <sup>1/4</sup>	G.1	700023580	2235
			G.2	700023583	2648
			G.3	700023614	2969
			G.4	700023590	3428
			G.1 2G	700023604	2235
			G.2 2G	700023607	2648
			G.3 2G	700023630	2969
			G.4 2G	700023591	3428

## SLIM BASIN

DEPTH 49CM / 19<sup>1/4</sup>"

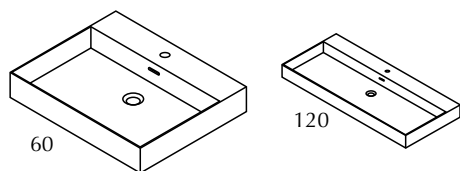

- GELCOAT basin with overflow.
- Requires for installation valve SAP100200010, 72 P.
- Lavabo GELCOAT con troppopieno.
- Richiede valvola SAP100200010, 72 P.
- Раковина GELCOAT с переливом.
- Требуется установка клапана SAP100200010, 72 P.

MEASURES	()	FINISHES	SAP	POINTS
60x10x49 / 23 <sup>5/8</sup> x3 <sup>7/8</sup> x19 <sup>1/4</sup>		GELCOAT	100221199	596
90x10x49 / 35 <sup>3/8</sup> x3 <sup>7/8</sup> x19 <sup>1/4</sup>			100221203	765
120x10x49 / 47 <sup>1/4</sup> x3 <sup>7/8</sup> x19 <sup>1/4</sup>			100221205	822

## MIRROR

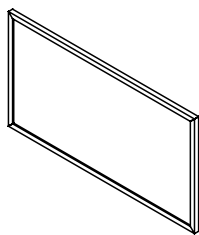

-Mirror.  
-Specchio  
-Зеркало.

MEASURES 	FINISHES	SAP	POINTS
60x48x3 / 23 <sup>5/8</sup> x18 <sup>7/8</sup> x1 <sup>1/8</sup>	Metal	700019870	310
90x48x3 / 35 <sup>3/8</sup> x18 <sup>7/8</sup> x1 <sup>1/8</sup>		700019842	354
120x48x3 / 47 <sup>1/4</sup> x18 <sup>7/8</sup> x1 <sup>1/8</sup>		700019852	360

## MIRROR



-Mirror.  
-Specchio  
-Зеркало.

MEASURES 	FINISHES	SAP	POINTS
48x60x3 / 18 <sup>7/8</sup> x23 <sup>5/8</sup> x1 <sup>1/8</sup>	Metal	700019861	310
48x90x3 / 18 <sup>7/8</sup> x35 <sup>3/8</sup> x1 <sup>1/8</sup>		700019853	354
48x120x3 / 18 <sup>7/8</sup> x47 <sup>1/4</sup> x1 <sup>1/8</sup>		700019841	360



The interpretation made in inches for the dimensions of the different items shown in the price list has been rounded to 1/8, however for a more accurate measurement please use millimetres or centimetres.

## Icon

<b>EXTERIOR FINISHES</b> FINITURE ESTERNE ОТДЕЛКА ДЛЯ НАРУЖНОГО ИСПОЛЬЗОВАНИЯ	<input type="checkbox"/> Laminate Laminato ЛАМИНАТ	<input checked="" type="checkbox"/> Matt lacquer Laccato opaco МАТОВЫЙ ЛАК	<input checked="" type="checkbox"/> Wood veneer Legno ДЕРЕВО
	<input type="checkbox"/> HPL Stratificato СЛОИСТАЯ	<input checked="" type="checkbox"/> Gloss lacquer Laccato lucido ГЛЯНЦЕВЫЙ ЛАК	
<b>INTERIOR FINISHES</b> FINITURE INTERNE ОТДЕЛКА ДЛЯ ВНУТРЕННЕГО ИСПОЛЬЗОВАНИЯ	<input type="checkbox"/> Laminate Laminato ЛАМИНАТ	<input type="checkbox"/> Wood veneer Legno ДЕРЕВО	<input checked="" type="checkbox"/> Aluminium+laminated base Alluminio + base in laminato Алюминий + основа из ламината
	<input type="checkbox"/> Front handle Maniglia frontale a vista Декоративная передняя ручка	<input type="checkbox"/> Integrated metal handle Maniglia metallica integrata Встроенная металлическая ручка	<input checked="" type="checkbox"/> Integrated mechanized h. Maniglia integrata ricavata sul bordo Встроенная ручка по краю
<b>HANDLES</b> MANIGLIE РУЧКИ	<input type="checkbox"/> Push handle Maniglia Push РУЧКИ Push		
<b>TYPE OF UNITS</b> TIPI DI MODULI ТИПЫ МОДУЛЕЙ	<input checked="" type="checkbox"/> Compact Compatto Компактная	<input checked="" type="checkbox"/> Modular Modulare Модульная	
<b>POSITION</b> POSIZIONE ПОЗИЦИЯ	<input checked="" type="checkbox"/> Wall-mounted Sospeso Подвесная	<input checked="" type="checkbox"/> Floor-mounted A terra Напольная	
<b>MEASURES (CM)</b> DIMENSIONI РАЗМЕРЫ	60 / 90 / 120	25 / 66 / 47	47
	23 <sup>5/8</sup> / 35 <sup>3/8</sup> / 47 <sup>1/4</sup>	9 <sup>7/8</sup> / 26 / 18 <sup>1/2</sup>	18 <sup>1/2</sup>
<b>WORKTOP &amp; BASIN OPTIONS</b> OPZIONI TOP E LAVABI ВАРИАНТЫ СТОЛЕШНИЦ И УМЫВАЛЬНЫХ РАКОВИН	<input checked="" type="checkbox"/> Bath serie's worktop / basin Lavabo / top della serie Серийная умывальная раковина / столешница	<input type="checkbox"/> Standard worktops Top standard Стандартные столешницы	<input type="checkbox"/> Worktop + integrated basin Encimera + lavabo integrato Столешница + встроенная умывальная раковина
	<input checked="" type="checkbox"/> Over-mounted basin Lavabo da appoggio Настольная умывальная раковина	<input type="checkbox"/> Under-mounted basin Lavabo sottopiano Умывальная раковина, встраиваемая в столешницу снизу	<input type="checkbox"/> Double basin as option Opzione doppia vasca Вариант с двойной чашей
<b>WORKTOP FINISHES</b> FINITURE TOP ОТДЕЛКА СТОЛЕШНИЦ	<input type="checkbox"/> Krion® worktop Top in KRION® Столешница KRION®	<input type="checkbox"/> Gel Coat worktop Top in Gel Coat Столешница с покрытием гелькоут	<input type="checkbox"/> Natural Stone worktop Top in pietra naturale Столешница из натурального камня.
	<input type="checkbox"/> Glass worktop Top in vetro Столешница из стекла	<input type="checkbox"/> Bath furniture finish worktop Top con la finitura del mobile Столешница с той же отделкой, что и консоль/тумба	
<b>BASIN FINISHES</b> FINITURE LAVABI ОТДЕЛКА УМЫВАЛЬНЫХ РАКОВИН	<input type="checkbox"/> Krion® basin Lavabo in Krion® Умывальная раковина из Krion®	<input type="checkbox"/> Gel Coat basin Lavabo Gelcoat Раковина Gelcoat	<input type="checkbox"/> Ceramic basin Lavabo in ceramica Керамическая умывальная раковина
	<input checked="" type="checkbox"/> Natural Stone basin Lavabo in pietra naturale Умывальная раковина из натурального камня.		
<b>ACCESSORIES</b> ACCESSORI АКСЕССУАРЫ	<input checked="" type="checkbox"/> Mirror Specchio Зеркало	<input checked="" type="checkbox"/> Wall-mounted module Modulo sospeso Подвесной модуль	<input checked="" type="checkbox"/> Tall cabinet Modulo colonna Высокий шкаф
	<input checked="" type="checkbox"/> Upper unit Modulo alto Верхний модуль	<input type="checkbox"/> Organizer Organizzatore Органайзер	<input type="checkbox"/> Shelves Mensola Полка
			<input checked="" type="checkbox"/> Accessories Accessori Аксессуары

*icon*

Icon is a bathroom unit with a natural oak wood strip veneer, specially treated to bring out the depth of the wood grain.

The drawer features an integrated J-shaped pull machined in the front, and the sides come in an exclusive coloured finish, specially created for Gamadecor. The accessories and mirror are made of aluminium and come in the same finish as the drawer sides.

Il mobile Icon è realizzato in impiallacciato di rovere naturale a listoni, sottoposto a un processo supplementare di lavorazione per donare una maggiore intensità alla profondità delle venature.

Il cassetto presenta la maniglia integrata e ricavata nel frontale con profilo a J.

I lati del cassetto sono finiti con un colore esclusivo per Gamadecor.

Gli accessori e lo specchio sono realizzati in alluminio e nella stessa finitura della parte laterale del cassetto.

Мебель Icon изготовлена из полос натурального дубового шпона, прошедшего дополнительную обработку, которая подчеркивает глубину жилок.

У ящика нет ручки в традиционном понимании этого слова: она встроена в переднюю панель в виде J-образного профиля.

Отделка боковых частей ящика имеет эксклюзивную расцветку, выполненную для Gamadecor.

Аксессуары и зеркало изготовлены из алюминия и отделаны так же, как и боковая часть ящика.

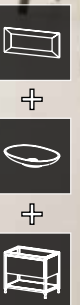

5846 Points  
**ICON roble carbón**

+info p.385





8181 Points  
ICON roble carbón

+info p.385



6664 Points  
ICON roble polvo

+info p.385

## FINISHES

WOOD

LEGNO

ДЕРЕВО



Roble Noche R.



Roble Cobre R.



Roble Bronce R.

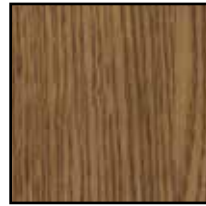

Roble Sil R.



Roble Alba R.



Roble Carbón R.



Roble Cuero R.



Roble Polvo R.



Roble Puro R.



GLOSS LACQUER

LACCATO LUCIDO

ГЛЯНЦЕВЫЙ ЛАК



Ónix

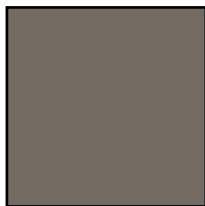

Cromo

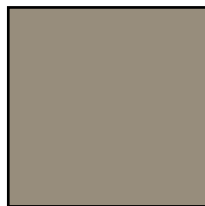

Férreo



Tórtola



Sílice

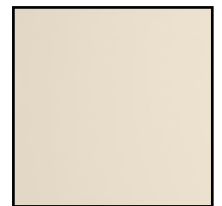

Bórax

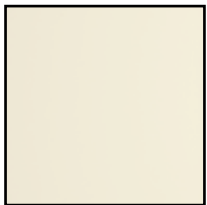

Cuarcita



Pizarra

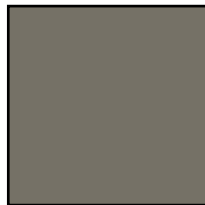

Grafito

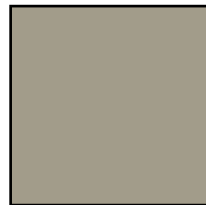

Plomo

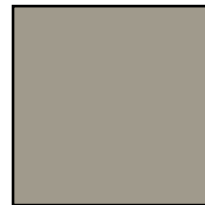

Limo

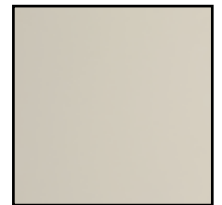

Pérgamon

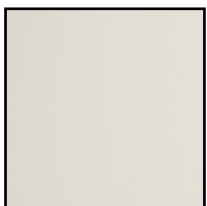

Alabastro

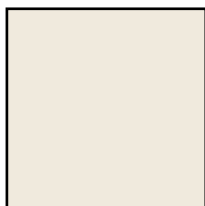

Porcelana



Negro Emotions



Ocean Blue



Azul Navy

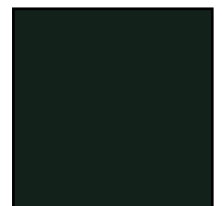

Bottle

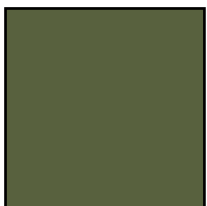

Orégano



Cúrcuma



Safrán



Curry

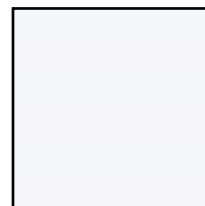

Blanco Snow

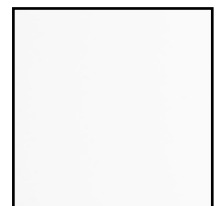

Blanco Emotions

## FINISHES

MATT LACQUER

LACCATO OPACO

МАТОВЫЙ ЛАК



Ónix



Cromo

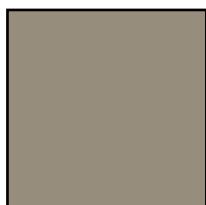

Férreo



Tórtola



Sílice



Bórax

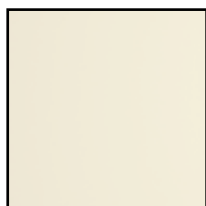

Cuarcita



Pizarra

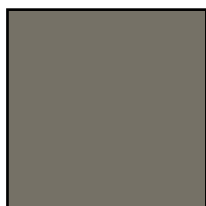

Grafito



Plomo



Limo



Pérgamon



Alabastro

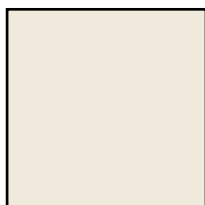

Porcelana

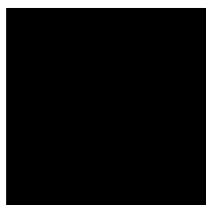

Negro Emotions



Ocean Blue



Azul Navy



Bottle



Orégano



Cúrcuma



Safrán



Curry

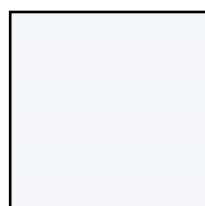

Blanco Snow

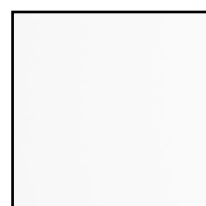

Blanco Emotions

WORKTOPS

TOP

СТОЛЕШНИЦЫ

A



Via Lactea



Mármol Carrara



G. Negro Tanzania M.



Granito Len



Barocco Vintage

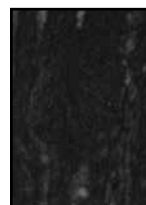

Cheyenne Vintage



Amarula Vintage

## WASH BASIN UNIT BPS-1

DEPTH 47,4CM / 18<sup>5/8"</sup>

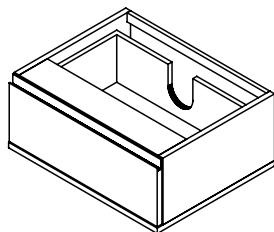

Wash basin unit.

Basi portalavabo

Тумбочка под умывальник.



MEASURES		FINISHES	SAP	POINTS
60x25,2x47,4 / 23 <sup>5/8</sup> x9 <sup>7/8</sup> x18 <sup>5/8</sup>		Gloss lacquer	700018726	1105
		Matt lacquer	700018713	998
		Wood	700018700	1515
90x25,2x47,4 / 35 <sup>3/8</sup> x9 <sup>7/8</sup> x18 <sup>5/8</sup>		Gloss lacquer	700018727	1255
		Matt lacquer	700018714	1123
		Wood	700018701	1765
120x25,2x47,4 / 47 <sup>1/4</sup> x9 <sup>7/8</sup> x18 <sup>5/8</sup>		Gloss lacquer	700018728	1404
		Matt lacquer	700018715	1245
		Wood	700018702	1997

## WASH BASIN UNIT BPS-H

DEPTH 47,4CM / 18<sup>5/8"</sup>

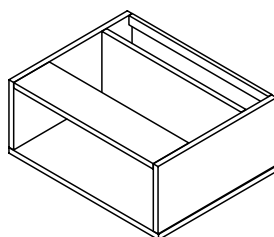

Wash basin unit.

Basi portalavabo

Тумбочка под умывальник.



MEASURES		FINISHES	SAP	POINTS
60x25,2x47,4 / 23 <sup>5/8</sup> x9 <sup>7/8</sup> x18 <sup>5/8</sup>		Gloss lacquer	700018729	775
		Matt lacquer	700018716	665
		Wood	700018703	1182
90x25,2x47,4 / 35 <sup>3/8</sup> x9 <sup>7/8</sup> x18 <sup>5/8</sup>		Gloss lacquer	700018730	883
		Matt lacquer	700018717	753
		Wood	700018704	1385
120x25,2x47,4 / 47 <sup>1/4</sup> x9 <sup>7/8</sup> x18 <sup>5/8</sup>		Gloss lacquer	700018731	1001
		Matt lacquer	700018718	844
		Wood	700018705	1565

## WASH BASIN UNIT BPT

DEPTH 47,4CM / 18<sup>5/8</sup>"

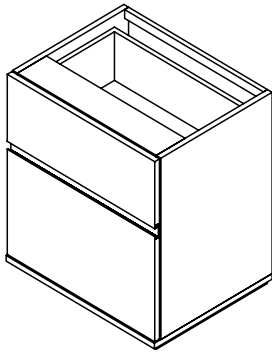

Wash basin unit.

Basi portalavabo

Тумбочка под умывальник.



MEASURES		FINISHES	SAP	POINTS
60x66,2x47,4 / 23 <sup>5/8</sup> x26 <sup>1/8</sup> x18 <sup>5/8</sup>		Gloss lacquer	700018732	1730
		Matt lacquer	700018719	1554
		Wood	700018706	2376
90x66,2x47,4 / 35 <sup>3/8</sup> x26 <sup>1/8</sup> x18 <sup>5/8</sup>		Gloss lacquer	700018733	1967
		Matt lacquer	700018720	1759
		Wood	700018707	2781
120x66,2x47,4 / 47 <sup>1/4</sup> x26 <sup>1/8</sup> x18 <sup>5/8</sup>		Gloss lacquer	700018734	2199
		Matt lacquer	700018721	1957
		Wood	700018708	3150

BP

## FREESTANDING UNIT MS-2

DEPTH 47,4CM / 18<sup>5/8</sup>"

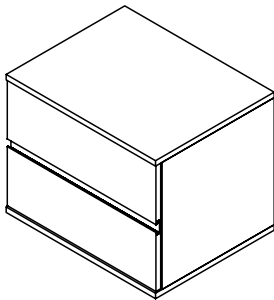

Wallmounted unit.

Modulo sospeso

Тумба для ванной, монтируемая на стену.

MEASURES		FINISHES	SAP	POINTS
45x47,8x47,4 / 17 <sup>3/4</sup> x18 <sup>7/8</sup> x18 <sup>5/8</sup>		Gloss lacquer	700018735	1533
		Matt lacquer	700018722	1354
		Wood	700018709	2099
60x47,8x47,4 / 23 <sup>5/8</sup> x18 <sup>7/8</sup> x18 <sup>5/8</sup>		Gloss lacquer	700018736	1649
		Matt lacquer	700018723	1450
		Wood	700018710	2316
90x47,8x47,4 / 35 <sup>3/8</sup> x18 <sup>7/8</sup> x18 <sup>5/8</sup>		Gloss lacquer	700018737	1934
		Matt lacquer	700018724	1685
		Wood	700018711	2773
120x47,8x47,4 / 47 <sup>1/4</sup> x18 <sup>7/8</sup> x18 <sup>5/8</sup>		Gloss lacquer	700018738	2215
		Matt lacquer	700018725	1913
		Wood	700018712	3195

MS

## WALL UNIT

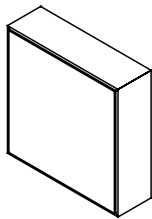

Wall unit with door.  
Modulo pensile con anta.  
Верхний блок с дверцей.

MEASURES		FINISHES	SAP	POINTS
45x48x18 / 17 <sup>3/4</sup> x18 <sup>7/8</sup> x7 <sup>1/8</sup>		Metal / Gloss lacquer	700015278	708
		Metal / Matt lacquer	700015279	688
		Metal / Wood	700018640	850
45x60x18 / 17 <sup>3/4</sup> x23 <sup>5/8</sup> x7 <sup>1/8</sup>		Metal / Gloss lacquer	700015294	767
		Metal / Matt lacquer	700015296	742
		Metal / Wood	700018642	913
60x60x18 / 23 <sup>5/8</sup> x23 <sup>5/8</sup> x7 <sup>1/8</sup>		Metal / Gloss lacquer	700015295	859
		Metal / Matt lacquer	700015420	828
		Metal / Wood	700018645	1037

## WALL UNIT / MIRROR

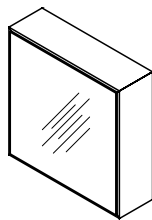

Wall unit with door. / Mirror.  
Modulo pensile con anta / Specchio.  
Верхний блок с дверцей. / Зеркало.

MEASURES		FINISHES	SAP	POINTS
45x48x18 / 17 <sup>3/4</sup> x18 <sup>7/8</sup> x7 <sup>1/8</sup>		Metal / Mirror	700018270	527
45x60x18 / 17 <sup>3/4</sup> x23 <sup>5/8</sup> x7 <sup>1/8</sup>			700018290	544
60x60x18 / 23 <sup>5/8</sup> x23 <sup>5/8</sup> x7 <sup>1/8</sup>			700018274	621

## WALL UNIT

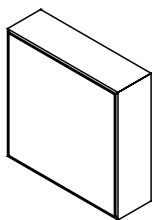

Wall unit with door.  
Modulo pensile con anta.  
Верхний блок с дверцей.

MEASURES		FINISHES	SAP	POINTS
45x48x18 / 17 <sup>3/4</sup> x18 <sup>7/8</sup> x7 <sup>1/8</sup>		Metal / Gloss lacquer	700015284	732
		Metal / Matt lacquer	700015288	712
		Metal / Wood	700018641	902
60x48x18 / 23 <sup>5/8</sup> x18 <sup>7/8</sup> x7 <sup>1/8</sup>		Metal / Gloss lacquer	700015285	815
		Metal / Matt lacquer	700015289	789
		Metal / Wood	700018644	1003
90x48x18 / 35 <sup>3/8</sup> x18 <sup>7/8</sup> x7 <sup>1/8</sup>		Metal / Gloss lacquer	700015286	992
		Metal / Matt lacquer	700015290	956
		Metal / Wood	700018647	1237
120x48x18 / 47 <sup>1/4</sup> x18 <sup>7/8</sup> x7 <sup>1/8</sup>		Metal / Gloss lacquer	700015287	1170
		Metal / Matt lacquer	700015291	1122
		Metal / Wood	700018628	1437

## WALL UNIT

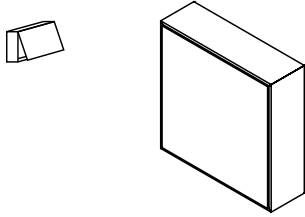

Wall unit with door.  
Modulo pensile con anta.  
Верхний блок с дверцей.

MEASURES	(  )	FINISHES	SAP	POINTS
45x60x18 / 17 <sup>3/4</sup> x23 <sup>5/8</sup> x7 <sup>1/8</sup>		Metal / Gloss lacquer	700015300	806
		Metal / Matt lacquer	700015303	781
		Metal / Wood	700018643	994
60x60x18 / 23 <sup>5/8</sup> x23 <sup>5/8</sup> x7 <sup>1/8</sup>		Metal / Gloss lacquer	700015301	898
		Metal / Matt lacquer	700015304	867
		Metal / Wood	700018646	1122
90x60x18 / 35 <sup>3/8</sup> x23 <sup>5/8</sup> x7 <sup>1/8</sup>		Metal / Gloss lacquer	700015302	1086
		Metal / Matt lacquer	700015305	1041
		Metal / Wood	700018648	1350

## WALL UNIT / MIRROR

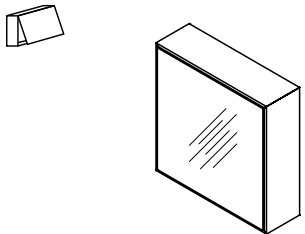

Wall unit with door. / Mirror.  
Modulo pensile con anta / Specchio.  
Верхний блок с дверцей. / Зеркало.

MEASURES	(  )	FINISHES	SAP	POINTS
45x48x18 / 17 <sup>3/4</sup> x18 <sup>7/8</sup> x7 <sup>1/8</sup>			700018263	593
60x48x18 / 23 <sup>5/8</sup> x18 <sup>7/8</sup> x7 <sup>1/8</sup>			700018264	624
90x48x18 / 35 <sup>3/8</sup> x18 <sup>7/8</sup> x7 <sup>1/8</sup>			700018275	711
120x48x18 / 47 <sup>1/4</sup> x18 <sup>7/8</sup> x7 <sup>1/8</sup>		Metal / Mirror	700018261	785
45x60x18 / 17 <sup>3/4</sup> x23 <sup>5/8</sup> x7 <sup>1/8</sup>			700018273	630
60x60x18 / 23 <sup>5/8</sup> x23 <sup>5/8</sup> x7 <sup>1/8</sup>			700018282	708
90x60x18 / 35 <sup>3/8</sup> x23 <sup>5/8</sup> x7 <sup>1/8</sup>			700018284	739

## SHELF

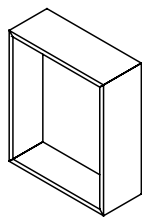

Shelf.  
Ripiano.  
Полка.

MEASURES		FINISHES	SAP	POINTS
45x36x12 / 17 <sup>3/4</sup> x14 <sup>1/8</sup> x4 <sup>3/4</sup>		Metal / Gloss lacquer	700015228	334
		Metal / Matt lacquer	700015230	304
		Metal / Wood	700018638	460
45x48x12 / 17 <sup>3/4</sup> x18 <sup>7/8</sup> x4 <sup>3/4</sup>		Metal / Gloss lacquer	700015229	375
		Metal / Matt lacquer	700015231	335
		Metal / Wood	700018639	515

## SHELF / MIRROR

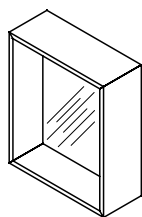

Shelf / Mirror.  
Ripiano / Specchio.  
Полка / Зеркало.

MEASURES		FINISHES	SAP	POINTS
45x36x9 / 17 <sup>3/4</sup> x14 <sup>1/8</sup> x3 <sup>1/2</sup>		Metal / Mirror	700015218	241
60x36x9 / 23 <sup>5/8</sup> x14 <sup>1/8</sup> x3 <sup>1/2</sup>			700015219	264
90x36x9 / 35 <sup>3/8</sup> x14 <sup>1/8</sup> x3 <sup>1/2</sup>			100160323	268
120x36x9 / 47 <sup>1/4</sup> x14 <sup>1/8</sup> x3 <sup>1/2</sup>			700015221	359
45x48x9 / 17 <sup>3/4</sup> x18 <sup>7/8</sup> x3 <sup>1/2</sup>			700015222	262
60x48x9 / 23 <sup>5/8</sup> x18 <sup>7/8</sup> x3 <sup>1/2</sup>			700015223	287
90x48x9 / 35 <sup>3/8</sup> x18 <sup>7/8</sup> x3 <sup>1/2</sup>			700015224	338
120x48x9 / 47 <sup>1/4</sup> x18 <sup>7/8</sup> x3 <sup>1/2</sup>	700015225	390		



## TALL CABINET MSC-3 WITHOUT FRONT

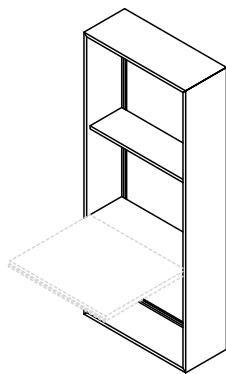

Tall cabinet. Front is required.  
 Colonna. Bisogna antina.  
 Высокий шкаф. Нуждается в фасаде.

MEASURES	(xx)	FINISHES	SAP	POINTS
30x108x18 / 11 <sup>3/4</sup> x42 <sup>1/2</sup> x7 <sup>1/8</sup>		Metal / Gloss lacquer	700015238	640
		Metal / Matt lacquer	700015240	599
		Metal / Wood	700018630	849
45x108x18 / 17 <sup>3/4</sup> x42 <sup>1/2</sup> x7 <sup>1/8</sup>		Metal / Gloss lacquer	700015239	733
		Metal / Matt lacquer	700015241	668
		Metal / Wood	700018634	1004

## TALL CABINET FRONT MSC-3

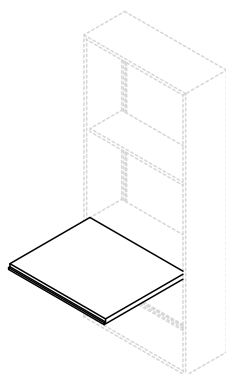

Column Front.  
 Porta colonna  
 Фасад высокого шкафа.

MEASURES	(xx)	FINISHES	SAP	POINTS
30x36x2 / 11 <sup>3/4</sup> x14 <sup>1/8</sup> x0 <sup>3/4</sup>		Gloss lacquer	700015244	385
		Matt lacquer	700015246	359
		Wood	700018624	459
45x36x2 / 17 <sup>3/4</sup> x14 <sup>1/8</sup> x0 <sup>3/4</sup>		Gloss lacquer	700015245	426
		Matt lacquer	700015247	397
		Wood	700018625	541

## TALL CABINET MSC-2 WITHOUT FRONT

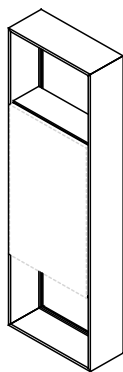

Tall cabinet. Front is required.

Colonna. Bisogna antina.

Высокий шкаф. Нуждается в фасаде.

MEASURES	(xx)	FINISHES	SAP	POINTS
30x144x18 / 11 <sup>3/4</sup> x56 <sup>3/4</sup> x7 <sup>1/8</sup>		Metal / Gloss lacquer	700015250	808
		Metal / Matt lacquer	700015252	757
		Metal / Wood	700018633	1106
45x144x18 / 17 <sup>3/4</sup> x56 <sup>3/4</sup> x7 <sup>1/8</sup>		Metal / Gloss lacquer	700015251	912
		Metal / Matt lacquer	700015253	848
		Metal / Wood	700018637	1325

## TALL CABINET FRONT MSC-2

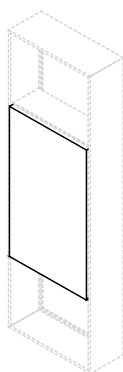

Column Front.

Porta colonna

Фасад высокого шкафа.

MEASURES	(xx)	FINISHES	SAP	POINTS
30x73x2 / 11 <sup>3/4</sup> x28 <sup>3/4</sup> x0 <sup>3/4</sup>		Gloss lacquer	700015256	301
		Matt lacquer	700015258	280
		Wood	700018626	357
45x73x2 / 17 <sup>3/4</sup> x28 <sup>3/4</sup> x0 <sup>3/4</sup>		Gloss lacquer	700015257	362
		Matt lacquer	700015259	332
		Wood	700018627	456

## TALL CABINET MSC

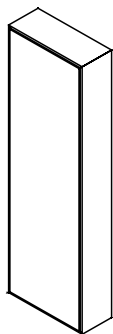

Tall cabinet push-to-open.  
Colonna apertura Push.  
Высокий шкаф с механизмом «нажал-открылось».

MEASURES	()	FINISHES	SAP	POINTS
30x144x18 / 11 <sup>3/4</sup> x56 <sup>3/4</sup> x7 <sup>1/8</sup>		Metal / Gloss lacquer	700015264	1132
		Metal / Matt lacquer	700015266	1097
		Metal / Mirror	700015260	1188
45x144x18 / 17 <sup>3/4</sup> x56 <sup>3/4</sup> x7 <sup>1/8</sup>		Metal / Gloss lacquer	700015265	1302
		Metal / Matt lacquer	700015267	1249
		Metal / Mirror	700015261	1284

## TALL CABINET

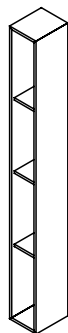

Tall cabinet.  
Colonna.  
Высокий шкаф.

MEASURES	()	FINISHES	SAP	POINTS
15x144x18 / 5 <sup>7/8</sup> x56 <sup>3/4</sup> x7 <sup>1/8</sup>		Metal / Gloss lacquer	700015271	687
		Metal / Matt lacquer	700015274	650
		Metal / Wood	700018629	874
30x144x18 / 11 <sup>3/4</sup> x56 <sup>3/4</sup> x7 <sup>1/8</sup>		Metal / Gloss lacquer	700015272	792
		Metal / Matt lacquer	700015275	742
		Metal / Wood	700018631	1095
45x144x18 / 17 <sup>3/4</sup> x56 <sup>3/4</sup> x7 <sup>1/8</sup>		Metal / Gloss lacquer	700015273	914
		Metal / Matt lacquer	700015276	833
		Metal / Wood	700018635	1315

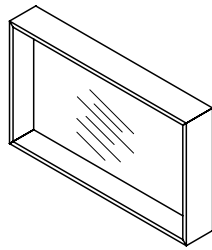

Mirror with light.  
Specchio con illuminazione.  
Зеркало с подсветкой.

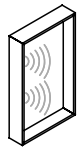

Light SX.

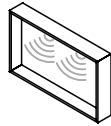

Light N.



Light DX.

MEASURES		FINISHES	SAP	POINTS
60x36x9 / 23 <sup>5/8</sup> x14 <sup>1/8</sup> x3 <sup>1/2</sup>			700019730	685
90x36x9 / 35 <sup>3/8</sup> x14 <sup>1/8</sup> x3 <sup>1/2</sup>		Metal	700019731	752
120x36x9 / 47 <sup>1/4</sup> x14 <sup>1/8</sup> x3 <sup>1/2</sup>			700019732	823
60x48x9 / 23 <sup>5/8</sup> x18 <sup>7/8</sup> x3 <sup>1/2</sup>			700019736	699
90x48x9 / 35 <sup>3/8</sup> x18 <sup>7/8</sup> x3 <sup>1/2</sup>		Metal	700019737	773
120x48x9 / 47 <sup>1/4</sup> x18 <sup>7/8</sup> x3 <sup>1/2</sup>			700019738	846
60x60x9 / 23 <sup>5/8</sup> x23 <sup>5/8</sup> x3 <sup>1/2</sup>			700019742	728
90x60x9 / 35 <sup>3/8</sup> x23 <sup>5/8</sup> x3 <sup>1/2</sup>		Metal	700019743	793
120x60x9 / 47 <sup>1/4</sup> x23 <sup>5/8</sup> x3 <sup>1/2</sup>			700019744	871

## MIRROR CICLO

DEPTH 4,5CM / 1<sup>3/4</sup>"

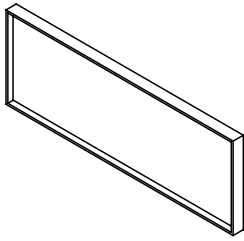

Mirror.  
Specchio  
Зеркало.

MEASURES (x x x)	FINISHES	SAP	POINTS
60x36x4,5 / 23 <sup>5/8</sup> x14 <sup>1/8</sup> x1 <sup>3/4</sup>	Metal	100138790	217
90x36x4,5 / 35 <sup>3/8</sup> x14 <sup>1/8</sup> x1 <sup>3/4</sup>	Metal	100138792	260
120x36x4,5 / 47 <sup>1/4</sup> x14 <sup>1/8</sup> x1 <sup>3/4</sup>	Metal	100138774	305
150x36x4,5 / 59x14 <sup>1/8</sup> x1 <sup>3/4</sup>	Metal	100138776	356
180x36x4,5 / 70 <sup>7/8</sup> x14 <sup>1/8</sup> x1 <sup>3/4</sup>	Metal	100138778	407
60x48x4,5 / 23 <sup>5/8</sup> x18 <sup>7/8</sup> x1 <sup>3/4</sup>	Metal	100138791	241
90x48x4,5 / 35 <sup>3/8</sup> x18 <sup>7/8</sup> x1 <sup>3/4</sup>	Metal	100138793	291
120x48x4,5 / 47 <sup>1/4</sup> x18 <sup>7/8</sup> x1 <sup>3/4</sup>	Metal	100138775	344
150x48x4,5 / 59x18 <sup>7/8</sup> x1 <sup>3/4</sup>	Metal	100138777	401
180x48x4,5 / 70 <sup>7/8</sup> x18 <sup>7/8</sup> x1 <sup>3/4</sup>	Metal	100138779	458

## MIRROR CICLO

DEPTH 4,5CM / 1<sup>3/4</sup>"

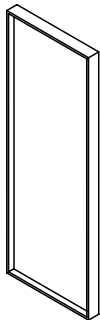

Mirror.  
Specchio  
Зеркало.

MEASURES (x x x)	FINISHES	SAP	POINTS
36x60x4,5 / 14 <sup>1/8</sup> x23 <sup>5/8</sup> x1 <sup>3/4</sup>	Metal	100145431	217
36x90x4,5 / 14 <sup>1/8</sup> x35 <sup>3/8</sup> x1 <sup>3/4</sup>	Metal	100145432	260
36x120x4,5 / 14 <sup>1/8</sup> x47 <sup>1/4</sup> x1 <sup>3/4</sup>	Metal	100145408	305
36x150x4,5 / 14 <sup>1/8</sup> x59x1 <sup>3/4</sup>	Metal	100145409	356
36x180x4,5 / 14 <sup>1/8</sup> x70 <sup>7/8</sup> x1 <sup>3/4</sup>	Metal	100145430	407
48x60x4,5 / 18 <sup>7/8</sup> x23 <sup>5/8</sup> x1 <sup>3/4</sup>	Metal	100145436	241
48x90x4,5 / 18 <sup>7/8</sup> x35 <sup>3/8</sup> x1 <sup>3/4</sup>	Metal	100145437	291
48x120x4,5 / 18 <sup>7/8</sup> x47 <sup>1/4</sup> x1 <sup>3/4</sup>	Metal	100145433	344
48x150x4,5 / 18 <sup>7/8</sup> x59x1 <sup>3/4</sup>	Metal	100145434	401
48x180x4,5 / 18 <sup>7/8</sup> x70 <sup>7/8</sup> x1 <sup>3/4</sup>	Metal	100145435	458

## ACCESSORY-HOLDER ROD

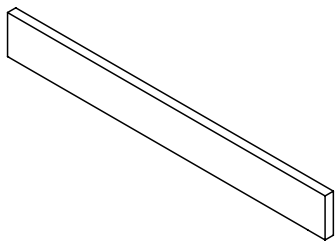

Accessory-holder rod.  
Mensola porta accessori.  
Стержень-держатель аксессуаров.

MEASURES		FINISHES	SAP	POINTS
30x9x5 / 11 <sup>3/4</sup> x3 <sup>1/2</sup> x2		Gloss lacquer	700029921	214
		Matt lacquer	700029935	185
		Wood (rustic-look veneer)	700029932	272
45x9x5 / 17 <sup>3/4</sup> x3 <sup>1/2</sup> x2		Gloss lacquer	700029970	233
		Matt lacquer	700029922	201
		Wood (rustic-look veneer)	700029962	296
60x9x5 / 23 <sup>5/8</sup> x3 <sup>1/2</sup> x2		Gloss lacquer	700015390	251
		Matt lacquer	700015397	217
		Wood (rustic-look veneer)	700018622	320
90x9x5 / 35 <sup>3/8</sup> x3 <sup>1/2</sup> x2		Gloss lacquer	700015391	312
		Matt lacquer	700015398	267
		Wood (rustic-look veneer)	700018623	403
120x9x5 / 47 <sup>1/4</sup> x3 <sup>1/2</sup> x2		Gloss lacquer	700015392	368
		Matt lacquer	700015399	319
		Wood (rustic-look veneer)	700018617	455
150x9x5 / 59x3 <sup>1/2</sup> x2		Gloss lacquer	700015393	426
		Matt lacquer	700015400	369
		Wood (rustic-look veneer)	700018618	528
180x9x5 / 70 <sup>7/8</sup> x3 <sup>1/2</sup> x2		Gloss lacquer	700015394	475
		Matt lacquer	700015401	416
		Wood (rustic-look veneer)	700018619	579
210x9x5 / 82 <sup>5/8</sup> x3 <sup>1/2</sup> x2		Gloss lacquer	700015395	530
		Matt lacquer	700015402	463
		Wood (rustic-look veneer)	700018620	658
240x9x5 / 94 <sup>1/2</sup> x3 <sup>1/2</sup> x2		Gloss lacquer	700015396	581
		Matt lacquer	700015403	508
		Wood (rustic-look veneer)	700018621	724

## SHELF

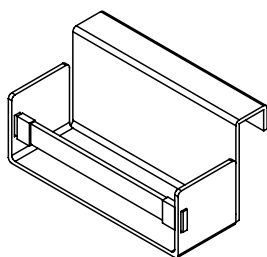

MEASURES	FINISHES	SAP	POINTS
24x13x12 / 9 <sup>1</sup> / <sub>2</sub> x5 <sup>1</sup> / <sub>8</sub> x4 <sup>3</sup> / <sub>4</sub>	Metal/Leather	100136305	181

## SHELF WITH POTS

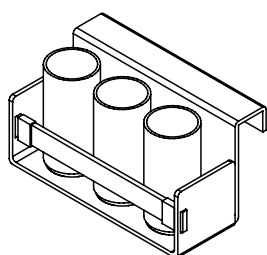

MEASURES	FINISHES	SAP	POINTS
24x13x12 / 9 <sup>1</sup> / <sub>2</sub> x5 <sup>1</sup> / <sub>8</sub> x4 <sup>3</sup> / <sub>4</sub>	Metal/Krion/Leather	100136306	379

## CIRCULAR TOWEL RACK

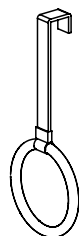

MEASURES	FINISHES	SAP	POINTS
16x36x4 / 6 <sup>1</sup> / <sub>4</sub> x14 <sup>1</sup> / <sub>8</sub> x1 <sup>5</sup> / <sub>8</sub>	Metal/Leather	100136307	117

## FLAT TOWEL RACK

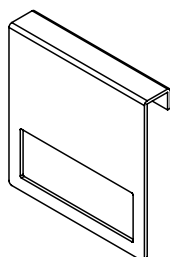

MEASURES	FINISHES	SAP	POINTS
24x24x3,6 / 9 <sup>1</sup> / <sub>2</sub> x9 <sup>1</sup> / <sub>2</sub> x1 <sup>3</sup> / <sub>8</sub>	Metal	100136308	101

## ACCESSORY-HOLDER SHELF

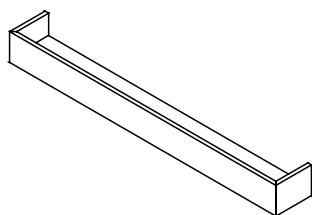

Accessory-holder shelf.  
 Mensola porta accessori.  
 Стержень-держатель аксессуаров.

MEASURES	()	FINISHES	SAP	POINTS
30x9x12 / 11 <sup>3/4</sup> x3 <sup>1/2</sup> x4 <sup>3/4</sup>		Metal / Krypton	700029960	186
45x9x12 / 17 <sup>3/4</sup> x3 <sup>1/2</sup> x4 <sup>3/4</sup>			100176532	190
60x9x12 / 23 <sup>5/8</sup> x3 <sup>1/2</sup> x4 <sup>3/4</sup>			100160321	214
90x9x12 / 35 <sup>3/8</sup> x3 <sup>1/2</sup> x4 <sup>3/4</sup>			700015234	260
120x9x12 / 47 <sup>1/4</sup> x3 <sup>1/2</sup> x4 <sup>3/4</sup>			700015235	311

## POT

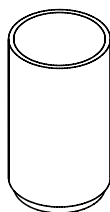

Pot.  
 Bidone  
 Металлический стаканчик

CM	MEASURES	()	FINISHES	SAP	POINTS
	6x10x6 / 2 <sup>3/8</sup> x3 <sup>7/8</sup> x2 <sup>3/8</sup>		Metal	100157824	56

## ICON KRION BASIN

DEPTH 47,7CM / 18<sup>3/4</sup>"

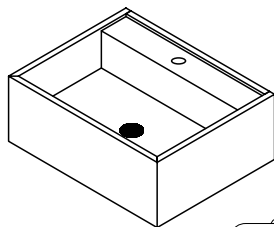

-Basin.  
 -Requires permanent valve SAP100036254, 68 P.  
 -It requires drainage SAP100036255, 103 P.  
 -Lavabo.  
 -Richiede valvola semplice di scarico libero con tappo coprialvola SAP100036254, 68 P.  
 -Richiede scarico SAP100036255, 103 P.  
 -Раковина.  
 -Требуется постоянный клапан SAP100036254, 68 P.  
 -Требуется дренаж SAP100036255, 103 P.



MEASURES	()	FINISHES	SAP	POINTS
60x22,8x47,7 / 23 <sup>5/8</sup> x9x18 <sup>3/4</sup>		Krypton	700018760	3242
90x22,8x47,7 / 35 <sup>3/8</sup> x9x18 <sup>3/4</sup>			700018770	3855
120x22,8x47,7 / 47 <sup>1/4</sup> x9x18 <sup>3/4</sup>			700018740	4450



## ICON BASIN

DEPTH 47,7CM / 18<sup>3/4</sup>"

### FINISHES:

- G-1:  Via Lactea, Mármol Carrara.
- G-2: Granito Len, Granito Tanzania Mate.
- G-3: Barocco Vintage, Cheyenne Vintage.
- G-4: Amarula Vintage.

## WORKTOPS

## TOP

## СТОЛЕШНИЦЫ





Via Lactea



Mármol Carrara



G. Negro Tanzania M.



Granito Len



Barocco Vintage



Cheyenne Vintage



Amarula Vintage

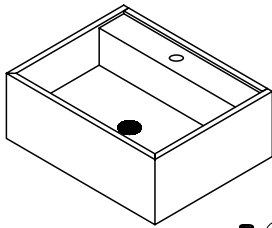

- Basin.
- Requires permanent valve SAP100036254, 68 P.
- It requires drainage SAP100036255, 103 P.
- Lavabo.
- Richiede valvola semplice di scarico libero con tappo coprivalvola SAP100036254, 68 P.
- Richiede scarico SAP100036255, 103 P.
- Раковина.
- Требуется постоянный клапан SAP100036254, 68 P.
- Требуется дренаж SAP100036255, 103 P.

MEASURES	FINISHES	SAP	POINTS
60x22,8x47,7 / 23 <sup>5/8</sup> x9x18 <sup>3/4</sup>	G1	700018750	2317
	G2		2567
	G3		2852
	G4		3174
90x22,8x47,7 / 35 <sup>3/8</sup> x9x18 <sup>3/4</sup>	G1	700018741	2666
	G2		2998
	G3		3406
	G4		3849
120x22,8x47,7 / 47 <sup>1/4</sup> x9x18 <sup>3/4</sup>	G1	700018739	3022
	G2		3457
	G3		3965
	G4		4531



The interpretation made in inches for the dimensions of the different items shown in the price list has been rounded to 1/8, however for a more accurate measurement please use millimetres or centimetres.

## Leaf

<b>EXTERIOR FINISHES</b> FINITURE ESTERNE ОТДЕЛКА ДЛЯ НАРУЖНОГО ИСПОЛЬЗОВАНИЯ	<input type="checkbox"/> Laminate Laminato ЛАМИНАТ	<input checked="" type="checkbox"/> Matt lacquer Laccato opaco МАТОВЫЙ ЛАК	<input checked="" type="checkbox"/> Wood veneer Legno ДЕРЕВО
	<input type="checkbox"/> HPL Stratificato СЛОИСТАЯ	<input checked="" type="checkbox"/> Gloss lacquer Laccato lucido ГЛЯНЦЕВЫЙ ЛАК	
<b>INTERIOR FINISHES</b> FINITURE INTERNE ОТДЕЛКА ДЛЯ ВНУТРЕННЕГО ИСПОЛЬЗОВАНИЯ	<input type="checkbox"/> Laminate Laminato ЛАМИНАТ	<input type="checkbox"/> Wood veneer Legno ДЕРЕВО	<input checked="" type="checkbox"/> Aluminium+laminated base Alluminio + base in laminato Алюминий + основа из ламината
	<input checked="" type="checkbox"/> Front handle Maniglia frontale a vista Декоративная передняя ручка	<input type="checkbox"/> Integrated metal handle Maniglia metallica integrata Встроенная металлическая ручка	<input type="checkbox"/> Integrated mechanized h. Maniglia integrata ricavata sul bordo Встроенная ручка по краю
<b>HANDLES</b> MANIGLIE РУЧКИ	<input type="checkbox"/> Push handle Maniglia Push РУЧКИ Push		
<b>TYPE OF UNITS</b> TIPI DI MODULI ТИПЫ МОДУЛЕЙ	<input checked="" type="checkbox"/> Compact Compatto Компактная	<input type="checkbox"/> Modular Modulare Модульная	
<b>POSITION</b> POSIZIONE ПОЗИЦИЯ	<input checked="" type="checkbox"/> Wall-mounted Sospeso Подвесная	<input type="checkbox"/> Floor-mounted A terra Напольная	
<b>MEASURES (CM)</b> DIMENSIONI РАЗМЕРЫ	◀ 60 / 90 / 120 23 <sup>5/8</sup> / 35 <sup>3/8</sup> / 47 <sup>1/4</sup>	▲ 36 14 <sup>1/8</sup>	↘ 51 20 <sup>1/8</sup>
<b>WORKTOP &amp; BASIN OPTIONS</b> OPZIONI TOP E LAVABI ВАРИАНТЫ СТОЛЕШНИЦ И УМЫВАЛЬНЫХ РАКОВИН	<input checked="" type="checkbox"/> Bath serie's worktop / basin Lavabo / top della serie Серийная умывальная раковина / столешница	<input type="checkbox"/> Standard worktops Top standard Стандартные столешницы	<input checked="" type="checkbox"/> Worktop + integrated basin Encimera + lavabo integrato Столешница + встроенная умывальная раковина
	<input type="checkbox"/> Over-mounted basin Lavabo da appoggio Настольная умывальная раковина	<input type="checkbox"/> Under-mounted basin Lavabo sottopiano Умывальная раковина, встраиваемая в столешницу снизу	<input checked="" type="checkbox"/> Double basin as option Opzione doppia vasca Вариант с двойной чашей
<b>WORKTOP FINISHES</b> FINITURE TOP ОТДЕЛКА СТОЛЕШНИЦ	<input checked="" type="checkbox"/> Krion® worktop Top in KRION® Столешница KRION®	<input type="checkbox"/> Gel Coat worktop Top in Gel Coat Столешница с покрытием гелькоут	<input type="checkbox"/> Natural Stone worktop Top in pietra naturale Столешница из натурального камня.
	<input type="checkbox"/> Glass worktop Top in vetro Столешница из стекла	<input type="checkbox"/> Bath furniture finish worktop Top con la finitura del mobile Столешница с той же отделкой, что и консоль/тумба	
<b>BASIN FINISHES</b> FINITURE LAVABI ОТДЕЛКА УМЫВАЛЬНЫХ РАКОВИН	<input checked="" type="checkbox"/> Krion® basin Lavabo in Krion® Умывальная раковина из Krion®	<input type="checkbox"/> Gel Coat basin Lavabo Gelcoat Раковина Gelcoat	<input type="checkbox"/> Ceramic basin Lavabo in ceramica Керамическая умывальная раковина
	<input type="checkbox"/> Natural Stone basin Lavabo in pietra naturale Умывальная раковина из натурального камня.		
<b>ACCESSORIES</b> ACCESSORI АКСЕССУАРЫ	<input checked="" type="checkbox"/> Mirror Specchio Зеркало	<input type="checkbox"/> Wall-mounted module Modulo sospeso Подвесной модуль	<input type="checkbox"/> Tall cabinet Modulo colonna Высокий шкаф
	<input type="checkbox"/> Upper unit Modulo alto Верхний модуль	<input type="checkbox"/> Organizer Organizzatore Органайзер	<input type="checkbox"/> Shelves Mensola Полка
			<input checked="" type="checkbox"/> Accessories Accessori Аксессуары

# leaf



Leaf bath furniture. The naturalness and simplicity are almost extreme with its mitred edges offering lightness and levity to the design. We must emphasize the dark side strip coming from the higher plane and going down through the vanity front composing the handle. The pure and minimalist aesthetics of the vanity set continues in the worktop with an integrated basin in its surface. It is possible due to the versatility, adaptability and capacity of the krion.

The hardware used in the Leaf vanity drawers has a unique finish exclusively designed for Gamadecor. Its global opening system allows opening its broad drawers in a homogeneous way by pulling only one of the sides.

Mobile da bagno Leaf. Naturalezza e semplicità nella loro massima espressione grazie agli angoli smussati che conferiscono leggerezza e lievità al design. Si distingue la fascia laterale scura che parte dal piano superiore e si abbassa passando per il frontale del mobile formando la maniglia. L'estetica pura e minimalista del gruppo del mobile da bagno continua nel top con lavabo integrato. Tutto questo è reso possibile dalla versatilità e adattabilità del Krion.

L'interno dei cassetti usati nei cassetti del mobile da bagno Leaf hanno una finitura esclusiva e unica disegnata da Gamadecor. Il sistema di apertura globale permette di aprire gli ampi cassetti in modo omogeneo tirando solo uno dei lati.

Мебель Leaf для ванной комнаты. Удивительная естественность и простота линий, достигаемые за счет скошенных граней. Мебель кажется легкой и невесомой. Обратите внимание на темную полосу сбоку, которая идет от верха до самого низа тумбы, обрамляя ручку. Минималистская эстетика тумбы распространяется и на столешницу, в которую встроена раковина. Такое решение стало возможно благодаря универсальности, гибкости и прочности криона.

Фурнитура тумб Leaf уникальна. Ее дизайн разработан специально для компании Gamadecor. Система полного открывания позволяет открывать широкие выдвигаемые ящики, потянув только за одну сторону.



+info p.385

# highline



SET 0322 3696 Points  
LEAF blanco snow mate  
100176394

## FINISHES

WOOD

LEGNO

ДЕРЕВО



Roble noche



Roble cobre



Roble bronce



Roble sil



Roble alba



Roble torrefacto



Nogal seda

GLOSS LACQUER

LACCATO LUCIDO

ГЛЯНЦЕВЫЙ ЛАК



Ónix

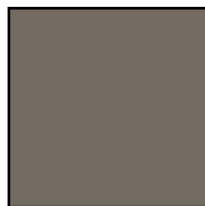

Cromo



Férreo



Tórtola



Sílice

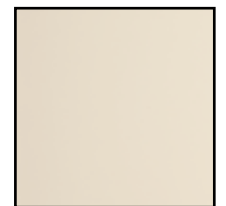

Bórax

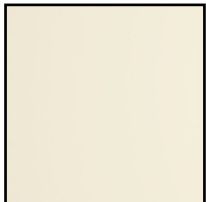

Cuarcita



Pizarra

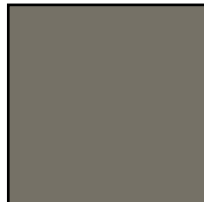

Grafito



Plomo



Limo

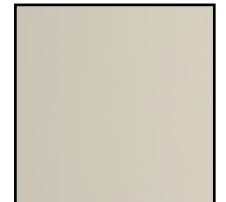

Pérgamon

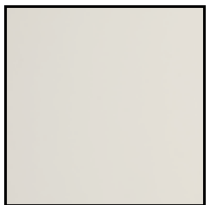

Alabastro

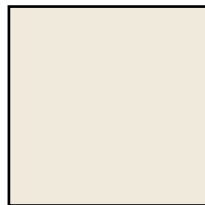

Porcelana

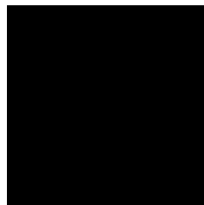

Negro Emotions



Ocean Blue



Azul Navy



Bottle

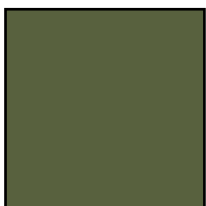

Orégano



Cúrcuma



Safrán



Curry

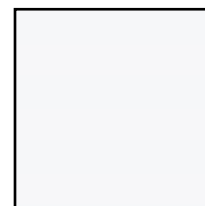

Blanco Snow

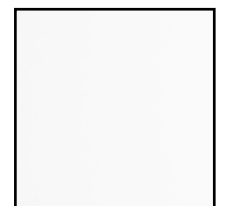

Blanco Emotions

## FINISHES

MATT LACQUER

LACCATO OPACO

МАТОВЫЙ ЛАК



Ónix

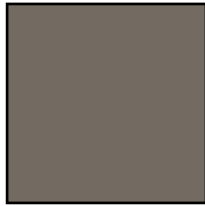

Cromo

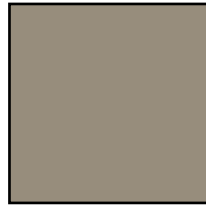

Férreo



Tórtola



Sílice

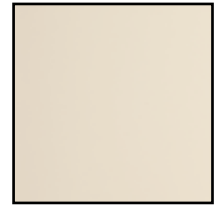

Bórax

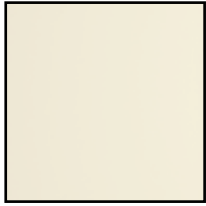

Cuarcita



Pizarra



Grafito

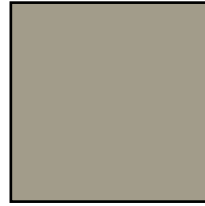

Plomo



Limo

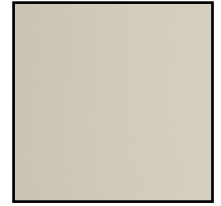

Pérgamon

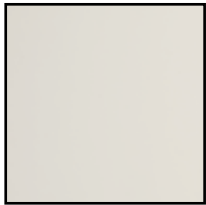

Alabastro

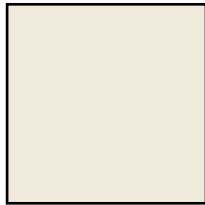

Porcelana



Negro Emotions



Ocean Blue



Azul Navy



Bottle



Orégano



Cúrcuma



Safrán



Curry



Blanco Snow

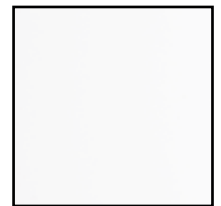

Blanco Emotions

# leaf

## WASH BASIN UNIT BPS 60 LEAF

DEPTH 51CM / 20<sup>1/8"</sup>

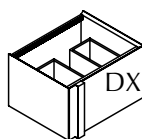
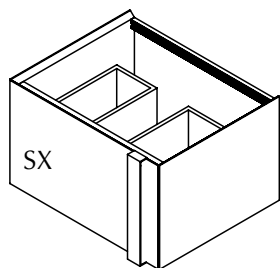

Wash basin unit.

Basi portalavabo

Тумбочка под умывальник.



MEASURES	(  )	FINISHES	BASIN	SAP	POINTS
60x36x51 / 23 <sup>5/8</sup> x14 <sup>1/8</sup> x20 <sup>1/8</sup>		Gloss lacquer	DX	700018355	1472
		Matt lacquer	DX	700018385	1377
		Wood	DX	700018356	1600
		Gloss lacquer	SX	700018374	1472
		Matt lacquer	SX	700018357	1377
		Wood	SX	700018375	1600

## WASH BASIN UNIT BPS 90 LEAF

DEPTH 51CM / 20<sup>1/8"</sup>

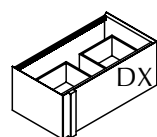
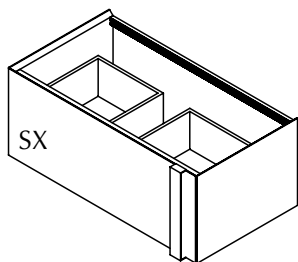

Wash basin unit.

Basi portalavabo

Тумбочка под умывальник.



MEASURES	(  )	FINISHES	BASIN	SAP	POINTS
90x36x51 / 35 <sup>3/8</sup> x14 <sup>1/8</sup> x20 <sup>1/8</sup>		Gloss lacquer	DX	700018387	1593
		Matt lacquer	DX	700018376	1488
		Wood	DX	700018388	1737
		Gloss lacquer	SX	700018377	1593
		Matt lacquer	SX	700018358	1488
		Wood	SX	700018379	1737

## WASH BASIN UNIT BPS 120 LEAF

DEPTH 51CM / 20<sup>1/8"</sup>

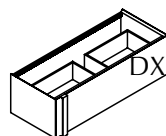
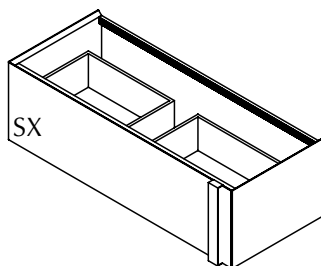

Wash basin unit.

Basi portalavabo

Тумбочка под умывальник.



MEASURES	(  )	FINISHES	BASIN	SAP	POINTS
120x36x51 / 47 <sup>1/4</sup> x14 <sup>1/8</sup> x20 <sup>1/8</sup>		Gloss lacquer	DX	700018363	1699
		Matt lacquer	DX	700018351	1575
		Wood	DX	700018373	1863
		Gloss lacquer	SX	700018353	1699
		Matt lacquer	SX	700018354	1575
		Wood	SX	700018384	1863



## WASH BASIN UNIT BPS 120 LEAF D/S

DEPTH 51CM / 20<sup>1/8</sup>"

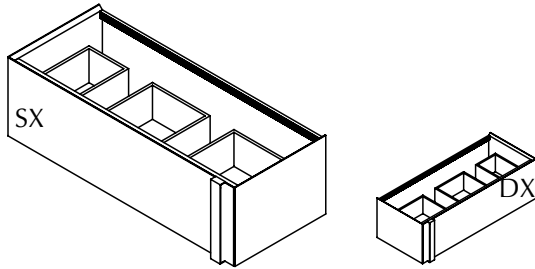

Wash basin unit.

Basi portlavabo

Тумбочка под умывальник.



MEASURES	(xx)	FINISHES	BASIN	SAP	POINTS	
120x36x51 / 47 <sup>1/4</sup> x14 <sup>1/8</sup> x20 <sup>1/8</sup>			Gloss lacquer	DX	700018390	1816
			Matt lacquer	DX	700018362	1692
			Wood	DX	700018380	1978
			Gloss lacquer	SX	700018352	1816
			Matt lacquer	SX	700018381	1692
			Wood	SX	700018364	1978

BP

## LEAF BASIN

DEPTH 48CM / 18<sup>7/8</sup>"

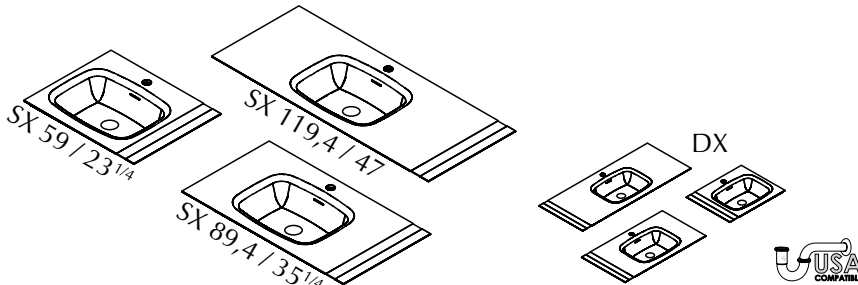

-KRION basin.

**-Requires valve SAP100174610 112P.**

**-Requires drainage SAP100036255 103P.**

-Lavabo KRION.

**-Richiede valvola SAP100174610 112P.**

**-Richiede scarico SAP100036255 103P.**

-Раковина KRION.

-Требуется постоянный перелив SAP100174610 112P.

-Требуется дренаж SAP100036255 103P.

MEASURES	(xx)	FINISHES	BASIN	SAP	POINTS
59x12x48 / 23 <sup>1/4</sup> x4 <sup>1/4</sup> x18 <sup>7/8</sup>			DX	100173936	1240
			SX	100173937	1240
89,4x12x48 / 35 <sup>1/4</sup> x4 <sup>1/4</sup> x18 <sup>7/8</sup>		KRION	DX	100173927	1470
			SX	100173957	1470
119,4x12x48 / 47x4 <sup>1/4</sup> x18 <sup>7/8</sup>			DX	100173924	1752
			SX	100173943	1752

## LEAF D/S BASIN

DEPTH 48CM / 18<sup>7/8</sup>"

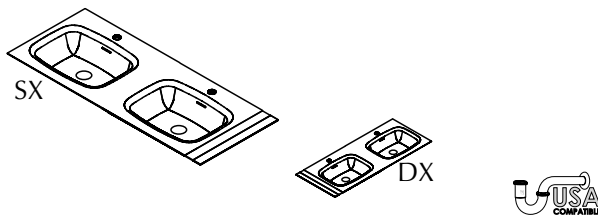

-KRION basin.

**-Requires valve SAP100174610 112P.**

**-Requires drainage SAP100036255 103P.**

-Lavabo KRION.

**-Richiede valvola SAP100174610 112P.**

**-Richiede scarico SAP100036255 103P.**

-Раковина KRION.

-Требуется постоянный перелив SAP100174610 112P.

-Требуется дренаж SAP100036255 103P.

MEASURES	(xx)	FINISHES	BASIN	SAP	POINTS
119,4x12x48 / 47x4 <sup>1/4</sup> x18 <sup>7/8</sup>		KRION	DX	100173953	2146
			SX	100173934	2146

## CLIK CLACK POP UP WASTE KRION



-Click-clack valve for sinks/basins with and without overflow. KRION.

-Valvola clik-clack per lavabi con et senza troppopieno. KRION.

-Донный клапан clik-clack для раковин с/без сливом-переливом. KRION.

SAP	POINTS
100174610	112

LA

## CICLO MIRROR

DEPTH 4,5CM / 1<sup>3</sup>/<sub>4</sub>"

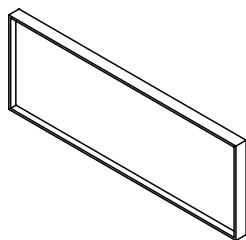

Horizontal mirror.  
Specchio orizzontale.  
Горизонтальное зеркало

MEASURES (x x x)	FINISHES	SAP	POINTS
60x36x4,5 / 23 <sup>5</sup> / <sub>8</sub> x14 <sup>1</sup> / <sub>8</sub> x1 <sup>3</sup> / <sub>4</sub>	Metal	100138790	217
90x36x4,5 / 35 <sup>3</sup> / <sub>8</sub> x14 <sup>1</sup> / <sub>8</sub> x1 <sup>3</sup> / <sub>4</sub>	Metal	100138792	260
120x36x4,5 / 47 <sup>1</sup> / <sub>4</sub> x14 <sup>1</sup> / <sub>8</sub> x1 <sup>3</sup> / <sub>4</sub>	Metal	100138774	305
150x36x4,5 / 59x14 <sup>1</sup> / <sub>8</sub> x1 <sup>3</sup> / <sub>4</sub>	Metal	100138776	356
180x36x4,5 / 70 <sup>7</sup> / <sub>8</sub> x14 <sup>1</sup> / <sub>8</sub> x1 <sup>3</sup> / <sub>4</sub>	Metal	100138778	407
60x48x4,5 / 23 <sup>5</sup> / <sub>8</sub> x18 <sup>7</sup> / <sub>8</sub> x1 <sup>3</sup> / <sub>4</sub>	Metal	100138791	241
90x48x4,5 / 35 <sup>3</sup> / <sub>8</sub> x18 <sup>7</sup> / <sub>8</sub> x1 <sup>3</sup> / <sub>4</sub>	Metal	100138793	291
120x48x4,5 / 47 <sup>1</sup> / <sub>4</sub> x18 <sup>7</sup> / <sub>8</sub> x1 <sup>3</sup> / <sub>4</sub>	Metal	100138775	344
150x48x4,5 / 59x18 <sup>7</sup> / <sub>8</sub> x1 <sup>3</sup> / <sub>4</sub>	Metal	100138777	401
180x48x4,5 / 70 <sup>7</sup> / <sub>8</sub> x18 <sup>7</sup> / <sub>8</sub> x1 <sup>3</sup> / <sub>4</sub>	Metal	100138779	458

## CICLO MIRROR

DEPTH 4,5CM / 1<sup>3</sup>/<sub>4</sub>"

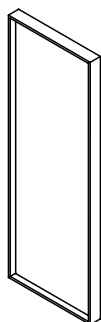

Vertical mirror.  
Specchio verticale.  
Вертикальное зеркало.

MEASURES (x x x)	FINISHES	SAP	POINTS
36x60x4,5 / 14 <sup>1</sup> / <sub>8</sub> x23 <sup>5</sup> / <sub>8</sub> x1 <sup>3</sup> / <sub>4</sub>	Metal	100145431	217
36x90x4,5 / 14 <sup>1</sup> / <sub>8</sub> x35 <sup>3</sup> / <sub>8</sub> x1 <sup>3</sup> / <sub>4</sub>	Metal	100145432	260
36x120x4,5 / 14 <sup>1</sup> / <sub>8</sub> x47 <sup>1</sup> / <sub>4</sub> x1 <sup>3</sup> / <sub>4</sub>	Metal	100145408	305
36x150x4,5 / 14 <sup>1</sup> / <sub>8</sub> x59x1 <sup>3</sup> / <sub>4</sub>	Metal	100145409	356
36x180x4,5 / 14 <sup>1</sup> / <sub>8</sub> x70 <sup>7</sup> / <sub>8</sub> x1 <sup>3</sup> / <sub>4</sub>	Metal	100145430	407
48x60x4,5 / 18 <sup>7</sup> / <sub>8</sub> x23 <sup>5</sup> / <sub>8</sub> x1 <sup>3</sup> / <sub>4</sub>	Metal	100145436	241
48x90x4,5 / 18 <sup>7</sup> / <sub>8</sub> x35 <sup>3</sup> / <sub>8</sub> x1 <sup>3</sup> / <sub>4</sub>	Metal	100145437	291
48x120x4,5 / 18 <sup>7</sup> / <sub>8</sub> x47 <sup>1</sup> / <sub>4</sub> x1 <sup>3</sup> / <sub>4</sub>	Metal	100145433	344
48x150x4,5 / 18 <sup>7</sup> / <sub>8</sub> x59x1 <sup>3</sup> / <sub>4</sub>	Metal	100145434	401
48x180x4,5 / 18 <sup>7</sup> / <sub>8</sub> x70 <sup>7</sup> / <sub>8</sub> x1 <sup>3</sup> / <sub>4</sub>	Metal	100145435	458

## ROD

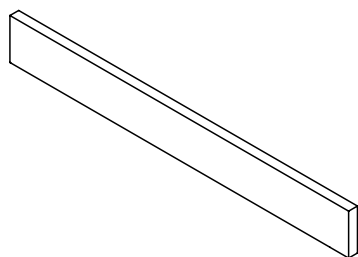

Accessory-holder rod.

Mensola porta accessori.

Стержень-держатель аксессуаров.

MEASURES 	FINISHES	SAP	POINTS
30x9x5 / 11 <sup>3/4</sup> x3 <sup>1/2</sup> x2	Gloss lacquer	700029921	214
	Matt lacquer	700029935	185
	Wood	700029942	267
45x9x5 / 17 <sup>3/4</sup> x3 <sup>1/2</sup> x2	Gloss lacquer	700029970	233
	Matt lacquer	700029922	201
	Wood	700029961	290
60x9x5 / 23 <sup>5/8</sup> x3 <sup>1/2</sup> x2	Gloss lacquer	700015390	251
	Matt lacquer	700015397	217
	Wood	700015383	313
90x9x5 / 35 <sup>3/8</sup> x3 <sup>1/2</sup> x2	Gloss lacquer	700015391	312
	Matt lacquer	700015398	267
	Wood	700015384	394
120x9x5 / 47 <sup>1/4</sup> x3 <sup>1/2</sup> x2	Gloss lacquer	700015392	368
	Matt lacquer	700015399	319
	Wood	700015385	444
150x9x5 / 59x3 <sup>1/2</sup> x2	Gloss lacquer	700015393	426
	Matt lacquer	700015400	369
	Wood	700015386	515
180x9x5 / 70 <sup>7/8</sup> x3 <sup>1/2</sup> x2	Gloss lacquer	700015394	475
	Matt lacquer	700015401	416
	Wood	700015387	565
210x9x5 / 82 <sup>5/8</sup> x3 <sup>1/2</sup> x2	Gloss lacquer	700015395	530
	Matt lacquer	700015402	463
	Wood	700015388	642
240x9x5 / 94 <sup>1/2</sup> x3 <sup>1/2</sup> x2	Gloss lacquer	700015396	581
	Matt lacquer	700015403	508
	Wood	700015389	705

# leaf

## SHELF

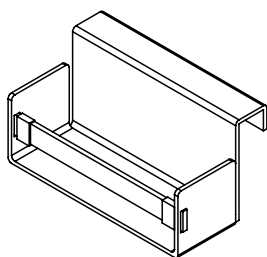

MEASURES		FINISHES	SAP	POINTS
24x13x12 / 9 <sup>1/2</sup> x5 <sup>1/8</sup> x4 <sup>3/4</sup>		Metal/Leather	100136305	181

## SHELF WITH POTS

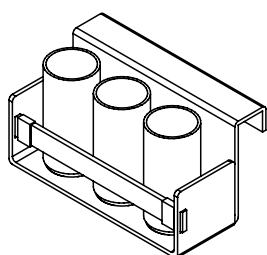

MEASURES		FINISHES	SAP	POINTS
24x13x12 / 9 <sup>1/2</sup> x5 <sup>1/8</sup> x4 <sup>3/4</sup>		Metal/Krion/Leather	100136306	379

## CIRCULAR TOWEL RACK

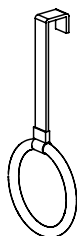

MEASURES		FINISHES	SAP	POINTS
16x36x4 / 6 <sup>1/4</sup> x14 <sup>1/8</sup> x1 <sup>5/8</sup>		Metal/Leather	100136307	117

## FLAT TOWEL RACK

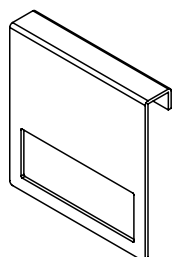

MEASURES		FINISHES	SAP	POINTS
24x24x3,6 / 9 <sup>1/2</sup> x9 <sup>1/2</sup> x1 <sup>3/8</sup>		Metal	100136308	101

## SHELF

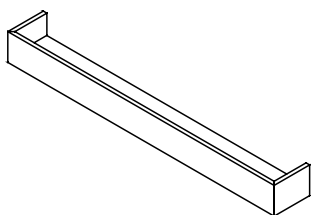

Accessory-holder shelf.  
Mensola porta accessori.  
Полка-держатель аксессуаров.

MEASURES 	FINISHES	SAP	POINTS
30x9x12 / 11 <sup>3/4</sup> x3 <sup>1/2</sup> x4 <sup>3/4</sup>	Metal / Krion	700029960	186
45x9x12 / 17 <sup>3/4</sup> x3 <sup>1/2</sup> x4 <sup>3/4</sup>		100176532	190
60x9x12 / 23 <sup>5/8</sup> x3 <sup>1/2</sup> x4 <sup>3/4</sup>		100160321	214
90x9x12 / 35 <sup>3/8</sup> x3 <sup>1/2</sup> x4 <sup>3/4</sup>		700015234	260
120x9x12 / 47 <sup>1/4</sup> x3 <sup>1/2</sup> x4 <sup>3/4</sup>		700015235	311

## POT

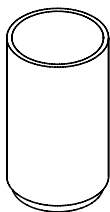

Pot.  
Bidone  
Металлический стаканчик

MEASURES 	FINISHES	SAP	POINTS
6x10x6 / 2 <sup>3/8</sup> x3 <sup>7/8</sup> x2 <sup>3/8</sup>	Metal	100157824	56



The interpretation made in inches for the dimensions of the different items shown in the price list has been rounded to 1/8, however for a more accurate measurement please use millimetres or centimetres.

## Soft

<b>EXTERIOR FINISHES</b> FINITURE ESTERNE ОТДЕЛКА ДЛЯ НАРУЖНОГО ИСПОЛЬЗОВАНИЯ	<input type="checkbox"/> Laminate Laminato ЛАМИНАТ	<input type="checkbox"/> Matt lacquer Laccato opaco МАТОВЫЙ ЛАК	<input type="checkbox"/> Wood veneer Legno ДЕРЕВО
	<input checked="" type="checkbox"/> HPL Stratificato СЛОИСТАЯ	<input type="checkbox"/> Gloss lacquer Laccato lucido ГЛЯНЦЕВЫЙ ЛАК	
<b>INTERIOR FINISHES</b> FINITURE INTERNE ОТДЕЛКА ДЛЯ ВНУТРЕННЕГО ИСПОЛЬЗОВАНИЯ	<input type="checkbox"/> Laminate Laminato ЛАМИНАТ	<input checked="" type="checkbox"/> Wood veneer Legno ДЕРЕВО	<input type="checkbox"/> Aluminium+laminated base Alluminio + base in laminato Алюминий + основа из ламината
	<input type="checkbox"/> Front handle Maniglia frontale a vista Декоративная передняя ручка	<input type="checkbox"/> Integrated metal handle Maniglia metallica integrata Встроенная металлическая ручка	<input checked="" type="checkbox"/> Integrated mechanized h. Maniglia integrata ricavata sul bordo Встроенная ручка по краю
<b>HANDLES</b> MANIGLIE РУЧКИ	<input type="checkbox"/> Push handle Maniglia Push РУЧКИ Push		
<b>TYPE OF UNITS</b> TIPI DI MODULI ТИПЫ МОДУЛЕЙ	<input checked="" type="checkbox"/> Compact Compatto Компактная	<input checked="" type="checkbox"/> Modular Modulare Модульная	
<b>POSITION</b> POSIZIONE ПОЗИЦИЯ	<input checked="" type="checkbox"/> Wall-mounted Sospeso Подвесная	<input type="checkbox"/> Floor-mounted A terra Напольная	
<b>MEASURES (CM)</b> DIMENSIONI РАЗМЕРЫ	60 / 90 / 120	24 / 48	48
	23 <sup>5/8</sup> / 35 <sup>3/8</sup> / 47 <sup>1/4</sup>	9 <sup>1/2</sup> / 18 <sup>7/8</sup>	18 <sup>7/8</sup>
<b>WORKTOP &amp; BASIN OPTIONS</b> OPZIONI TOP E LAVABI ВАРИАНТЫ СТОЛЕШНИЦ И УМЫВАЛЬНЫХ РАКОВИН	<input checked="" type="checkbox"/> Bath serie's worktop / basin Lavabo / top della serie Серийная умывальная раковина / столешница	<input type="checkbox"/> Standard worktops Top standard Стандартные столешницы	<input type="checkbox"/> Worktop + integrated basin Encimera + lavabo integrato Столешница + встроенная умывальная раковина
	<input checked="" type="checkbox"/> Over-mounted basin Lavabo da appoggio Настольная умывальная раковина	<input checked="" type="checkbox"/> Under-mounted basin Lavabo sottopiano Умывальная раковина, встраиваемая в столешницу снизу	<input checked="" type="checkbox"/> Double basin as option Opzione doppia vasca Вариант с двойной чашей
<b>WORKTOP FINISHES</b> FINITURE TOP ОТДЕЛКА СТОЛЕШНИЦ	<input type="checkbox"/> Krion® worktop Top in KRION® Столешница KRION®	<input type="checkbox"/> Gel Coat worktop Top in Gel Coat Столешница с покрытием гелькоут	<input type="checkbox"/> Natural Stone worktop Top in pietra naturale Столешница из натурального камня.
	<input type="checkbox"/> Glass worktop Top in vetro Столешница из стекла	<input checked="" type="checkbox"/> Bath furniture finish worktop Top con la finitura del mobile Столешница с той же отделкой, что и консоль/тумба	
<b>BASIN FINISHES</b> FINITURE LAVABI ОТДЕЛКА УМЫВАЛЬНЫХ РАКОВИН	<input checked="" type="checkbox"/> Krion® basin Lavabo in Krion® Умывальная раковина из Krion®	<input checked="" type="checkbox"/> Gel Coat basin Lavabo Gelcoat Раковина Gelcoat	<input type="checkbox"/> Ceramic basin Lavabo in ceramica Керамическая умывальная раковина
	<input type="checkbox"/> Natural Stone basin Lavabo in pietra naturale Умывальная раковина из натурального камня.		
<b>ACCESSORIES</b> ACCESSORI АКСЕССУАРЫ	<input type="checkbox"/> Mirror Specchio Зеркало	<input checked="" type="checkbox"/> Wall-mounted module Modulo sospeso Подвесной модуль	<input type="checkbox"/> Tall cabinet Modulo colonna Высокий шкаф
	<input type="checkbox"/> Upper unit Modulo alto Верхний модуль	<input type="checkbox"/> Organizer Organizzatore Органайзер	<input type="checkbox"/> Shelves Mensola Полка
			<input type="checkbox"/> Accessories Accessori Аксессуары

## soft



Vanity made of nanotechnological matt stratified with anti-fingerprint, self-regenerating and fat-repellent properties.

Assembled with FOLDING system.

Manufacturing of pure lines with mechanized mitred handle- The interior drawer is made in wood and an integrated bucket can be attached.

Mobile fabbricato con stratificato opaco nanotecnologico con proprietà anti-impronta, autorigeneranti, e anti grasso.

Assemblato con sistema FOLDING.

Costruzione dalle linee pure con maniglia meccanizzata a smusso. Il cassetto interno è fabbricato in legno e può alloggiare un bidone integrato.

Тумба для ванной имеет тончайшее матовое покрытие, которое самовосстанавливается, отталкивает жир и защищено от отпечатков пальцев.

Тумба собрана по системе FOLDING.

Ясные четкие линии, скошенная ручка. Внутренний выдвижной ящик выполнен из дерева, предусмотрено место для ведра.



+info p.386

SET 0454 2783 Points  
SOFT noche ghost  
10022333



# highline



+info p.386

3468 Points  
SOFT gris carbono ghost



+info p.386

3213 Points  
SOFT negro ghost

soft

## FINISHES

HPL

STRATIFICATO

СЛОИСТАЯ

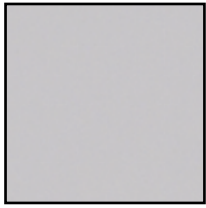

Gris trama ghost



Café ghost



Fango ghost



Noche ghost



Gris carbonoghost



Negro ghost

## WASH BASIN UNIT BPS-1

DEPTH 48,3CM / 19"

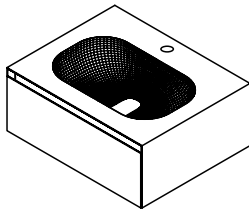

- SOFT SOTTO basin included.
- Requires valve SAP100104178 59P.
- Requires drainage SAP100138072 40P.

- Lavabo SOFT SOTTO incluso.
- Richiede valvola SAP100104178 59P.
- Richiede scarico SAP100138072 40P.

- Прилагается умывальная раковина SOFT SOTTO.
- Требуется постоянный перелив SAP100104178 59P.
- Требуется дренаж SAP100138072 40P.

MEASURES	( x  x )	FINISHES	SAP	POINTS
60x24x48,3	/ 23 <sup>5/8</sup> x9 <sup>1/2</sup> x19	Stratified ghost	700015844	1594
80x24x48,3	/ 31 <sup>1/2</sup> x9 <sup>1/2</sup> x19		700026187	1692
90x24x48,3	/ 35 <sup>3/8</sup> x9 <sup>1/2</sup> x19		700015872	1740
100x24x48,3	/ 39 <sup>3/8</sup> x9 <sup>1/2</sup> x19		700026202	1786
120x24x48,3	/ 47 <sup>1/4</sup> x9 <sup>1/2</sup> x19		700015881	1877

## WASH BASIN UNIT BPS-2

DEPTH 48,3CM / 19"

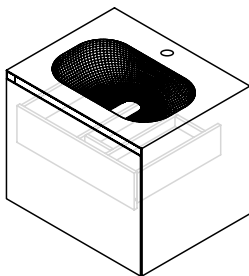

- SOFT SOTTO basin included.
- Requires valve SAP100104178 59P.
- Requires drainage SAP100036255 103P.

- Lavabo SOFT SOTTO incluso.
- Richiede valvola SAP100104178 59P.
- Richiede scarico SAP100036255 103P.

- Прилагается умывальная раковина SOFT SOTTO.
- Требуется постоянный перелив SAP100104178 59P.
- Требуется дренаж SAP100036255 103P.

MEASURES	( x  x )	FINISHES	SAP	POINTS
60x48x48,3	/ 23 <sup>5/8</sup> x18 <sup>7/8</sup> x19	Stratified ghost	700015871	1914
80x48x48,3	/ 31 <sup>1/2</sup> x18 <sup>7/8</sup> x19		700026191	2061
90x48x48,3	/ 35 <sup>3/8</sup> x18 <sup>7/8</sup> x19		700015873	2134
100x48x48,3	/ 39 <sup>3/8</sup> x18 <sup>7/8</sup> x19		700026166	2226
120x48x48,3	/ 47 <sup>1/4</sup> x18 <sup>7/8</sup> x19		700015862	2410

## WASH BASIN UNIT BPS-1 120 DS

DEPTH 48,3CM / 19"

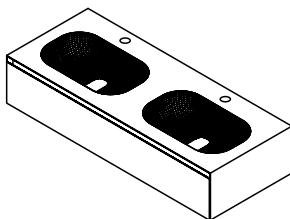

- SOFT SOTTO basin included.
- Requires valve SAP100104178 59P.
- Requires drainage SAP100138072 40P.

- Lavabo SOFT SOTTO incluso.
- Richiede valvola SAP100104178 59P.
- Richiede scarico SAP100138072 40P.

- Прилагается умывальная раковина SOFT SOTTO.
- Требуется постоянный перелив SAP100104178 59P.
- Требуется дренаж SAP100138072 40P.

MEASURES	( x  x )	FINISHES	SAP	POINTS
120x24x48,3	/ 47 <sup>1/4</sup> x9 <sup>1/2</sup> x19	Stratified ghost	700015847	2502

## WASH BASIN UNIT BPS-2 120 DS

DEPTH 48,3CM / 19"

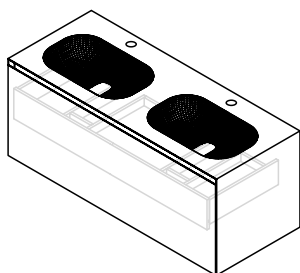

-SOFT SOTTO basin included.  
**-Requires valve SAP100104178 59P.**  
**-Requires drainage SAP100036255 103P.**

-Lavabo SOFT SOTTO incluso.  
**-Richiede valvola SAP100104178 59P.**  
**-Richiede scarico SAP100036255 103P.**  
 -Прилагается умывальная раковина SOFT SOTTO.  
 -Требуется постоянный перелив SAP100104178 59P.  
 -Требуется дренаж SAP100036255 103P.

MEASURES	()	FINISHES	SAP	POINTS
120x48x48,3 / 47 <sup>1/4</sup> x18 <sup>7/8</sup> x19		Stratified ghost	700015883	3036

## WASH BASIN UNIT BPS-1

DEPTH 48,3CM / 19"

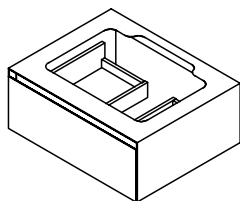

**-Requires drainage SAP100138072 40P.**

**-Richiede scarico SAP100138072 40P.**

-Требуется дренаж SAP100138072 40P.

BPS-1 60: CICLO 50, ONES 60.  
 BPS-1 90: CICLO 50, CICLO 70, ONES 60, ONES 70.  
 BPS-1 120: CICLO 50, CICLO 70, ONES 60, ONES 70, ONES 115.

MEASURES	()	FINISHES	SAP	POINTS
60x24x48,3 / 23 <sup>5/8</sup> x9 <sup>1/2</sup> x19		Stratified ghost	700015860	1111
80x24x48,3 / 31 <sup>1/2</sup> x9 <sup>1/2</sup> x19			700026173	1209
90x24x48,3 / 35 <sup>3/8</sup> x9 <sup>1/2</sup> x19			700015852	1257
100x24x48,3 / 39 <sup>3/8</sup> x9 <sup>1/2</sup> x19			700026165	1303
120x24x48,3 / 47 <sup>1/4</sup> x9 <sup>1/2</sup> x19			700015880	1394

## WASH BASIN UNIT BPS-2

DEPTH 48,3CM / 19"

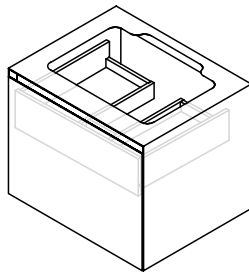

-Requires drainage SAP100036255 103P.

-Richiede scarico SAP100036255 103P.

-Требуется дренаж SAP100036255 103P.

BPS-2 60: CICLO 50, ONES 60.

BPS-2 90: CICLO 50, CICLO 70, ONES 60, ONES 70.

BPS-2 120: CICLO 50, CICLO 70, ONES 60, ONES 70, ONES 115.

MEASURES	( x  x )	FINISHES	SAP	POINTS
60x48x48,3	23 <sup>5/8</sup> x18 <sup>7/8</sup> x19	Stratified ghost	700015870	1431
80x48x48,3	31 <sup>1/2</sup> x18 <sup>7/8</sup> x19		700026167	1578
90x48x48,3	35 <sup>3/8</sup> x18 <sup>7/8</sup> x19		700015846	1651
100x48x48,3	39 <sup>3/8</sup> x18 <sup>7/8</sup> x19		700026186	1743
120x48x48,3	47 <sup>1/4</sup> x18 <sup>7/8</sup> x19		700015853	1926

## WASH BASIN UNIT BPS-1 120 DS

DEPTH 48,3CM / 19"

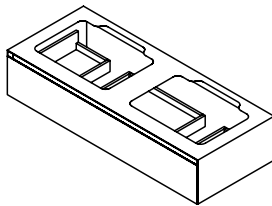

-Requires drainage SAP100138072 40P.

-Richiede scarico SAP100138072 40P.

-Требуется дренаж SAP100138072 40P.

BPS-1 120 DS: CICLO 50.

MEASURES	( x  x )	FINISHES	SAP	POINTS
120x24x48,3	47 <sup>1/4</sup> x9 <sup>1/2</sup> x19	Stratified ghost	700015850	1446

## WASH BASIN UNIT BPS-2 120 DS

DEPTH 48,3CM / 19"

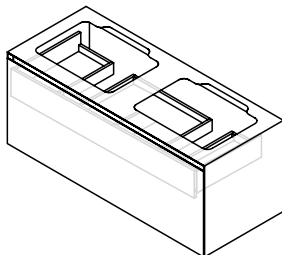

-Requires drainage SAP100036255 103P.

-Richiede scarico SAP100036255 103P.

-Требуется дренаж SAP100036255 103P.

BPS-2 120 DS: CICLO 50.

MEASURES	( x  x )	FINISHES	SAP	POINTS
120x48x48,3	47 <sup>1/4</sup> x18 <sup>7/8</sup> x19	Stratified ghost	700015882	1980

## FREESTANDING UNIT MS-1 60

DEPTH 48,3CM / 19"

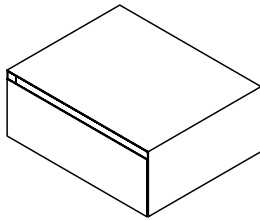

Wallmounted unit.  
Modulo sospeso.  
Блок настенного монтажа.

MEASURES		FINISHES	SAP	POINTS
60x24x48,3 / 23 <sup>5/8</sup> x9 <sup>1/2</sup> x19		Stratified ghost	700015845	1069

## FREESTANDING UNIT MS-2 60

DEPTH 48,3CM / 19"

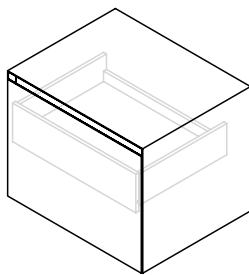

Wallmounted unit.  
Modulo sospeso.  
Блок настенного монтажа.

MEASURES		FINISHES	SAP	POINTS
60x48x48,3 / 23 <sup>5/8</sup> x18 <sup>7/8</sup> x19		Stratified ghost	700015861	1389

## FREESTANDING UNIT MS-1 90

DEPTH 48,3CM / 19"

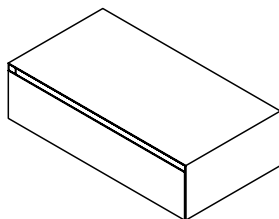

Wallmounted unit.  
Modulo sospeso.  
Блок настенного монтажа.

MEASURES		FINISHES	SAP	POINTS
90x24x48,3 / 35 <sup>3/8</sup> x9 <sup>1/2</sup> x19		Stratified ghost	700015848	1232

## FREESTANDING UNIT MS-2 90

DEPTH 48,3CM / 19"

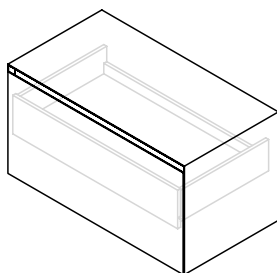

Wallmounted unit.  
Modulo sospeso.  
Блок настенного монтажа.

MEASURES		FINISHES	SAP	POINTS
90x48x48,3 / 35 <sup>3/8</sup> x18 <sup>7/8</sup> x19		Stratified ghost	700015849	1625

## FREESTANDING UNIT MS-1 120

DEPTH 48,3CM / 19"

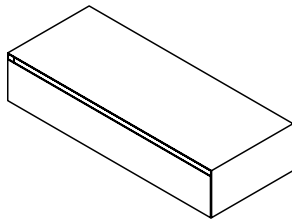

Wallmounted unit.  
Modulo sospeso  
Блок настенного монтажа.

MEASURES		FINISHES	SAP	POINTS
120x24x48,3 / 47 <sup>1/4</sup> x9 <sup>1/2</sup> x19		Stratified ghost	700015854	1375

## FREESTANDING UNIT MS-2 120

DEPTH 48,3CM / 19"

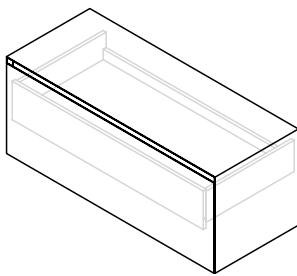

Wallmounted unit.  
Modulo sospeso  
Блок настенного монтажа.

MEASURES		FINISHES	SAP	POINTS
120x48x48,3 / 47 <sup>1/4</sup> x18 <sup>7/8</sup> x19		Stratified ghost	700015851	1845

## TALL CABINET

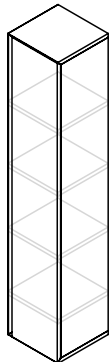

Tall cabinet.  
Colonna.  
Высокий шкаф..

MEASURES		FINISHES	SAP	POINTS	
30x156x30 / 11 <sup>3/4</sup> x61 <sup>3/8</sup> x11 <sup>3/4</sup>		Stratified ghost	DX	700026192	1468
			SX	700026168	

MS

soft

MC

## CICLO BASIN SEMI-RECESSED

DEPTH 48CM / 18<sup>7/8</sup>"

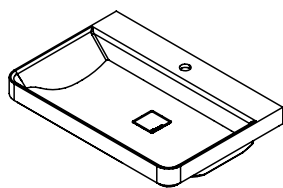

- GELCOAT basin.
- It requires permanent overflow (100104178 / 59 Points).
- Lavabo GELCOAT.
- Richiede valvola (100104178 / 59 punti).
- Раковина GELCOAT.
- Требуется постоянный перелив (100104178 / 59 позиций).



- Optional black plate (250055710 / 143 points).
- Copriletta nero opzionale (250055710 / 143 punti).
- Опционально черная накладка (250055710 / 143 пунктов).

MEASURES	FINISHES	SAP	POINTS
50x15x48 / 19 <sup>5/8</sup> x5 <sup>7/8</sup> x18 <sup>7/8</sup>	GELCOAT	100136309	632
70x15x48 / 27 <sup>1/2</sup> x5 <sup>7/8</sup> x18 <sup>7/8</sup>		100128501	736

## ONES BASIN SEMI-RECESSED

DEPTH 48CM / 18<sup>7/8</sup>"

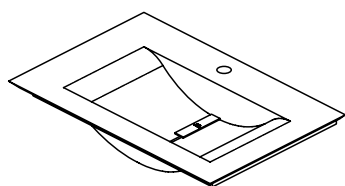

- GELCOAT basin.
- Lavabo GELCOAT.
- Раковина GELCOAT.



- Optional black plate (250055696 / 150 points).
- Copriletta nero opzionale (250055696 / 150 punti).
- Опционально черная накладка (250055696 / 150 пунктов).

MEASURES	FINISHES	SAP	POINTS
60x13x48 / 23 <sup>5/8</sup> x5 <sup>1/8</sup> x18 <sup>7/8</sup>	GELCOAT	100110452	0942
71,5x13x48 / 28 <sup>1/8</sup> x5 <sup>1/8</sup> x18 <sup>7/8</sup>		100100508	0982
115x13x48 / 45 <sup>1/4</sup> x5 <sup>1/8</sup> x18 <sup>7/8</sup>		100100507	1202

## SLIM BASIN COUNTERTOP / SOBRE ENCIMERA / VASQUE SUR PLAN

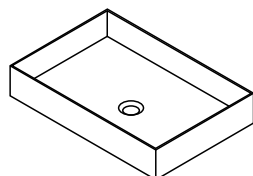

- GELCOAT basin.
- Requires for installation valve SAP100036254, 68 P.
- Lavabo GELCOAT.
- Richiede valvola SAP100036254, 68 P.
- Раковина GELCOAT.
- Требуется установка клапана SAP100036254, 68 P.

MEASURES	FINISHES	SAP	POINTS
50x10x33 / 19 <sup>5/8</sup> x3 <sup>7/8</sup> x13	GELCOAT	100221198	475

## PERMANENT VALVE EVACUATION



- Permanent valve evacuation.
- Valvola semplice a caduta libera.
- Постоянный перелив.

SAP	POINTS
100104178	59

## DRAINAGE

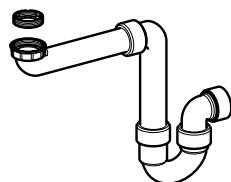

- Drainage.
- Scarico.
- Дренаж.

LA

FINISHES	SAP	POINTS
Polypropylene	100138072	40



# highline

soft



The interpretation made in inches for the dimensions of the different items shown in the price list has been rounded to 1/8, however for a more accurate measurement please use millimetres or centimetres.

## Dess

<b>EXTERIOR FINISHES</b> FINITURE ESTERNE ОТДЕЛКА ДЛЯ НАРУЖНОГО ИСПОЛЬЗОВАНИЯ	<input type="checkbox"/> Laminate Laminato ЛАМИНАТ	<input checked="" type="checkbox"/> Matt lacquer Laccato opaco МАТОВЫЙ ЛАК	<input checked="" type="checkbox"/> Wood veneer Legno ДЕРЕВО
	<input type="checkbox"/> HPL Stratificato СЛОИСТАЯ	<input checked="" type="checkbox"/> Gloss lacquer Laccato lucido ГЛЯНЦЕВЫЙ ЛАК	
<b>INTERIOR FINISHES</b> FINITURE INTERNE ОТДЕЛКА ДЛЯ ВНУТРЕННЕГО ИСПОЛЬЗОВАНИЯ	<input type="checkbox"/> Laminate Laminato ЛАМИНАТ	<input type="checkbox"/> Wood veneer Legno ДЕРЕВО	<input checked="" type="checkbox"/> Aluminium+laminated base Alluminio + base in laminato Алюминий + основа из ламината
	<input type="checkbox"/> Front handle Maniglia frontale a vista Декоративная передняя ручка	<input type="checkbox"/> Integrated metal handle Maniglia metallica integrata Встроенная металлическая ручка	<input checked="" type="checkbox"/> Integrated mechanized h. Maniglia integrata ricavata sul bordo Встроенная ручка по краю
<b>HANDLES</b> MANIGLIE РУЧКИ	<input type="checkbox"/> Push handle Maniglia Push РУЧКИ Push		
<b>TYPE OF UNITS</b> TIPI DI MODULI ТИПЫ МОДУЛЕЙ	<input checked="" type="checkbox"/> Compact Compatto Компактная	<input checked="" type="checkbox"/> Modular Modulare Модульная	
<b>POSITION</b> POSIZIONE ПОЗИЦИЯ	<input checked="" type="checkbox"/> Wall-mounted Sospeso Подвесная	<input type="checkbox"/> Floor-mounted A terra Напольная	
<b>MEASURES (CM)</b> DIMENSIONI РАЗМЕРЫ	45 / 60 / 90 / 120	35 / 47	48
	17 <sup>3/4</sup> / 23 <sup>5/8</sup> / 35 <sup>3/8</sup> / 47 <sup>1/4</sup>	13 <sup>3/4</sup> / 18 <sup>1/2</sup>	18 <sup>7/8</sup>
<b>WORKTOP &amp; BASIN OPTIONS</b> OPZIONI TOP E LAVABI ВАРИАНТЫ СТОЛЕШНИЦ И УМЫВАЛЬНЫХ РАКОВИН	<input checked="" type="checkbox"/> Bath serie's worktop / basin Lavabo / top della serie Серийная умывальная раковина / столешница	<input type="checkbox"/> Standard worktops Top standard Стандартные столешницы	<input checked="" type="checkbox"/> Worktop + integrated basin Encimera + lavabo integrato Столешница + встроенная умывальная раковина
	<input type="checkbox"/> Over-mounted basin Lavabo da appoggio Настольная умывальная раковина	<input type="checkbox"/> Under-mounted basin Lavabo sottopiano Умывальная раковина, встраиваемая в столешницу снизу	<input type="checkbox"/> Double basin as option Opzione doppia vasca Вариант с двойной чашей
<b>WORKTOP FINISHES</b> FINITURE TOP ОТДЕЛКА СТОЛЕШНИЦ	<input type="checkbox"/> Krion® worktop Top in KRION® Столешница KRION®	<input checked="" type="checkbox"/> Gel Coat worktop Top in Gel Coat Столешница с покрытием гелькоут	<input type="checkbox"/> Natural Stone worktop Top in pietra naturale Столешница из натурального камня.
	<input type="checkbox"/> Glass worktop Top in vetro Столешница из стекла	<input type="checkbox"/> Bath furniture finish worktop Top con la finitura del mobile Столешница с той же отделкой, что и консоль/тумба	
<b>BASIN FINISHES</b> FINITURE LAVABI ОТДЕЛКА УМЫВАЛЬНЫХ РАКОВИН	<input type="checkbox"/> Krion® basin Lavabo in Krion® Умывальная раковина из Krion®	<input checked="" type="checkbox"/> Gel Coat basin Lavabo Gelcoat Раковина Gelcoat	<input type="checkbox"/> Ceramic basin Lavabo in ceramica Керамическая умывальная раковина
	<input type="checkbox"/> Natural Stone basin Lavabo in pietra naturale Умывальная раковина из натурального камня.		
<b>ACCESSORIES</b> ACCESSORI АКСЕССУАРЫ	<input checked="" type="checkbox"/> Mirror Specchio Зеркало	<input checked="" type="checkbox"/> Wall-mounted module Modulo sospeso Подвесной модуль	<input checked="" type="checkbox"/> Tall cabinet Modulo colonna Высокий шкаф
	<input checked="" type="checkbox"/> Upper unit Modulo alto Верхний модуль	<input type="checkbox"/> Organizer Organizzatore Органайзер	<input checked="" type="checkbox"/> Shelves Mensola Полка
			<input checked="" type="checkbox"/> Accessories Accessori Аксессуары

# dess



Modular bathroom cabinet with wide variety of options both in modules and in finishes. The design of the set is characterized by its horizontal handle that is integrated throughout all the modules, sides, and tops with recessing, the final thickness of which is 8 mm, which gives the DESS series a lightweight appearance. Similarly, the DESS washbasin with Gelcoat finish, also has this thickness reduction at the edges in order to follow this lightweight line. The top modules, mirrors, and shelves, are made from aluminum frames with stainless steel or black 100% Metal finish, in the inside of which a back panel, a mirror, or a veneer, lacquer, or mirror door can be installed.

Mobile da bagno modulare con grande varietà di opzioni sia di moduli che di finiture. il disegno del gruppo è caratterizzato dalla maniglia orizzontale integrata lungo tutto il modulo e i fianchi e top con rientranza con spessore finale di 8 mm che conferisce una presenza più leggera e lieve alla serie DESS. Anche il lavabo DESS con finitura Gelcoat, ha uno spessore ridotto nei bordi per continuare la leggerezza della linea. I moduli pensile, gli specchi e i ripiani hanno telai in alluminio in finitura acciaio inox o nero sabbato 100% che possono ospitare un pannello posteriore, uno specchio o un'anta impiacciata, laccato o specchio.

Модульный шкаф для ванной комнаты. Разнообразные варианты отделки и компоновки модулей. Характерной особенностью дизайна этого комплекта является горизонтальная ручка, встроенная во все модули по боковым и верхним сторонам, имеющая углубление и конечную ширину 8 мм, что придает серии DESS ощущение легкости.

Так же невесомо выглядит и умывальная раковина DESS с отделкой Gelcoat, тоже имеющая характерное уменьшение толщины по кромкам. В оформлении верхних модулей, зеркал и полок используются алюминиевые рамы (цвета нержавеющей стали или полностью черные). Внутри можно установить заднюю панель, зеркало, а также фанерную, зеркальную или покрытую лаком дверцу.



+info p.386

10562 Points  
DESS borax brillo / roble bronze



**SET 0472** 3564 Points  
**DESS roble torrefacto**  
 100243222

+info p.387



**SET 0473** 3074 Points  
**DESS roble noche**  
 100243927

+info p.387



+info p.387



**3394 Points**  
**DESS limo brillo**

des

**FINISHES**

WOOD

LEGNO

ДЕРЕВО



Roble noche



Roble cobre



Roble bronce



Roble sil



Roble alba



Roble torrefacto



Nogal seda

GLOSS LACQUER

LACCATO LUCIDO

ГЛЯНЦЕВЫЙ ЛАК



Ónix

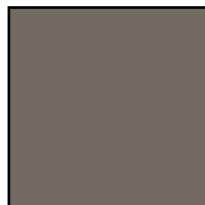

Cromo

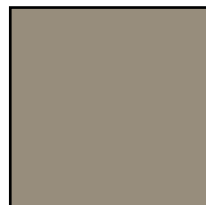

Férreo



Tórtola



Sílice

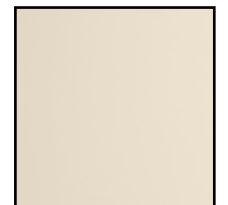

Bórax

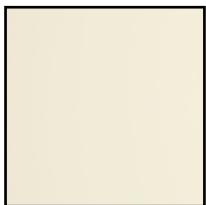

Cuarcita



Pizarra

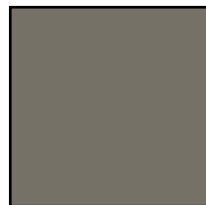

Grafito



Plomo

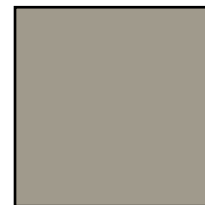

Limo

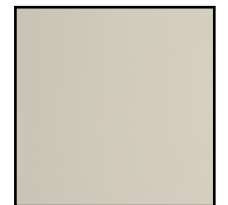

Pérgamon

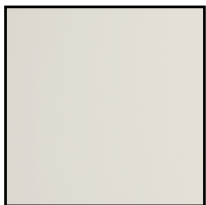

Alabastro

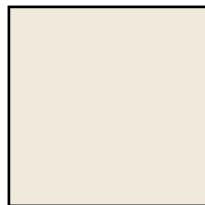

Porcelana



Negro Emotions



Ocean Blue



Azul Navy



Bottle

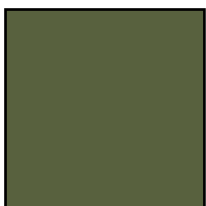

Orégano



Cúrcuma



Safrán



Curry

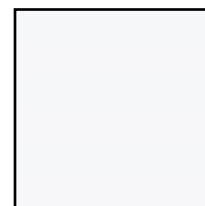

Blanco Snow

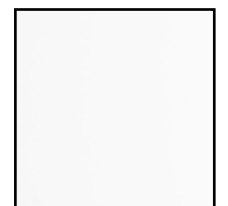

Blanco Emotions

## FINISHES

MATT LACQUER

LACCATO OPACO

МАТОВЫЙ ЛАК



Ónix

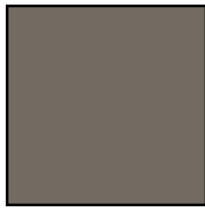

Cromo

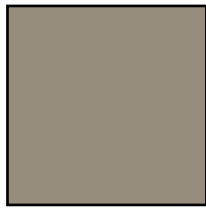

Férreo



Tórtola



Sílice

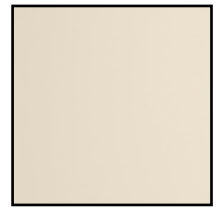

Bórax

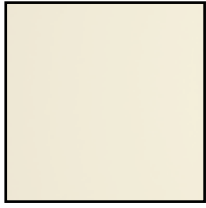

Cuarcita



Pizarra



Grafito



Plomo



Limo

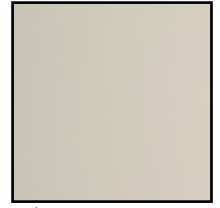

Pérgamon

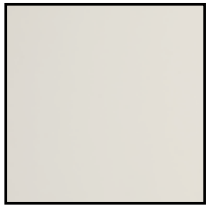

Alabastro

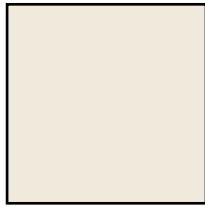

Porcelana



Negro Emotions



Ocean Blue



Azul Navy



Bottle

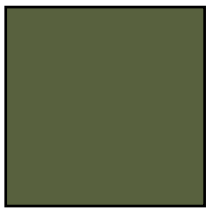

Orégano



Cúrcuma

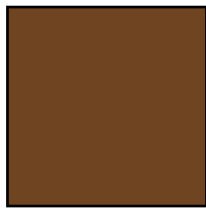

Safrán



Curry



Blanco Snow

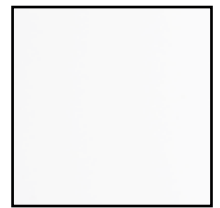

Blanco Emotions

## WASH BASIN UNIT BPS-1C

DEPTH 48,5CM / 19<sup>1</sup>/<sub>8</sub>"

35,2 / 13<sup>7</sup>/<sub>8</sub>

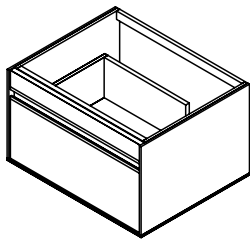

**Full** basin unit.

Base portalavabo **completa**.

Тумбочка под умывальник полностью.

MEASURES	(xx)	FINISHES	SAP	POINTS
60x35,2x48,5 / 23 <sup>5</sup> / <sub>8</sub> x13 <sup>7</sup> / <sub>8</sub> x19 <sup>1</sup> / <sub>8</sub>		Gloss lacquer	700015106	1758
		Matt lacquer	700015162	1603
		Wood	700015050	1962
90x35,2x48,5 / 35 <sup>3</sup> / <sub>8</sub> x13 <sup>7</sup> / <sub>8</sub> x19 <sup>1</sup> / <sub>8</sub>		Gloss lacquer	700015107	2011
		Matt lacquer	700015163	1829
		Wood	700015051	2245
120x35,2x48,5 / 47 <sup>1</sup> / <sub>4</sub> x13 <sup>7</sup> / <sub>8</sub> x19 <sup>1</sup> / <sub>8</sub>		Gloss lacquer	700015108	2271
		Matt lacquer	700015164	2061
		Wood	700015052	2528

## WASH BASIN UNIT BPS-1C USA COMPATIBLE

DEPTH 48,5CM / 19<sup>1</sup>/<sub>8</sub>"

35,2 / 13<sup>7</sup>/<sub>8</sub>

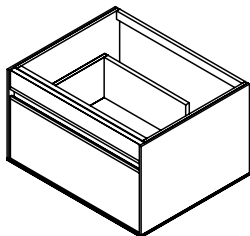

**Full** basin unit.

Base portalavabo **completa**.

Тумбочка под умывальник полностью.



MEASURES	(xx)	FINISHES	SAP	POINTS
60x35,2x48,5 / 23 <sup>5</sup> / <sub>8</sub> x13 <sup>7</sup> / <sub>8</sub> x19 <sup>1</sup> / <sub>8</sub>		Gloss lacquer	700022893	1934
		Matt lacquer	700022894	1779
		Wood	700022895	2138
90x35,2x48,5 / 35 <sup>3</sup> / <sub>8</sub> x13 <sup>7</sup> / <sub>8</sub> x19 <sup>1</sup> / <sub>8</sub>		Gloss lacquer	700022917	2187
		Matt lacquer	700022918	2005
		Wood	700022919	2421
120x35,2x48,5 / 47 <sup>1</sup> / <sub>4</sub> x13 <sup>7</sup> / <sub>8</sub> x19 <sup>1</sup> / <sub>8</sub>		Gloss lacquer	700022869	2447
		Matt lacquer	700022870	2237
		Wood	700022871	2704



## WASH BASIN UNIT BPS-1 SX

DEPTH 48,5CM / 19<sup>1</sup>/<sub>8</sub>"

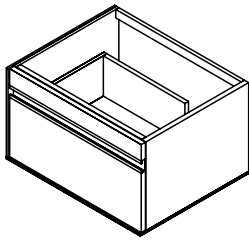

35,2 / 13<sup>7</sup>/<sub>8</sub>



Basin unit with **NO** right side.

Base portalavabo **SENZA** spalla destra.

Тумбочка под умывальник БЕЗ правой боковой стороны.

MEASURES	(  x  x  )	FINISHES	SAP	POINTS
60x35,2x48,5 / 23 <sup>5</sup> / <sub>8</sub> x13 <sup>7</sup> / <sub>8</sub> x19 <sup>1</sup> / <sub>8</sub>		Gloss lacquer	700015109	1691
		Matt lacquer	700015165	1538
		Wood	700015053	1904
90x35,2x48,5 / 35 <sup>3</sup> / <sub>8</sub> x13 <sup>7</sup> / <sub>8</sub> x19 <sup>1</sup> / <sub>8</sub>		Gloss lacquer	700015110	1944
		Matt lacquer	700015166	1764
		Wood	700015054	2187
120x35,2x48,5 / 47 <sup>1</sup> / <sub>4</sub> x13 <sup>7</sup> / <sub>8</sub> x19 <sup>1</sup> / <sub>8</sub>		Gloss lacquer	700015111	2204
		Matt lacquer	700015167	1996
		Wood	700015055	2470

## WASH BASIN UNIT BPS-1 SX USA COMPATIBLE

DEPTH 48,5CM / 19<sup>1</sup>/<sub>8</sub>"

35,2 / 13<sup>7</sup>/<sub>8</sub>

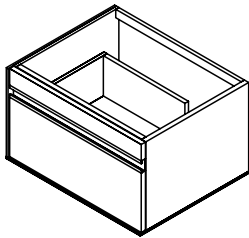



Basin unit with **NO** right side.

Base portalavabo **SENZA** spalla destra.

Тумбочка под умывальник БЕЗ правой боковой стороны.



MEASURES	(  x  x  )	FINISHES	SAP	POINTS
60x35,2x48,5 / 23 <sup>5</sup> / <sub>8</sub> x13 <sup>7</sup> / <sub>8</sub> x19 <sup>1</sup> / <sub>8</sub>		Gloss lacquer	700022890	1867
		Matt lacquer	700022891	1714
		Wood	700022892	2080
90x35,2x48,5 / 35 <sup>3</sup> / <sub>8</sub> x13 <sup>7</sup> / <sub>8</sub> x19 <sup>1</sup> / <sub>8</sub>		Gloss lacquer	700022914	2120
		Matt lacquer	700022915	1940
		Wood	700022916	2363
120x35,2x48,5 / 47 <sup>1</sup> / <sub>4</sub> x13 <sup>7</sup> / <sub>8</sub> x19 <sup>1</sup> / <sub>8</sub>		Gloss lacquer	700022866	2380
		Matt lacquer	700022867	2172
		Wood	700022868	2646

## WASH BASIN UNIT BPS-1 DX

DEPTH 48,5CM / 19<sup>1</sup>/<sub>8</sub>"

35,2 / 13<sup>7</sup>/<sub>8</sub>

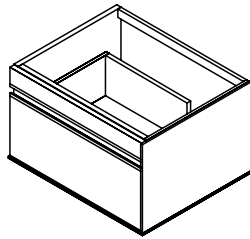

Basin unit with **NO** left side.

Base portalavabo **SENZA** spalla sinistra.

Тумбочка под умывальник БЕЗ левой боковой стороны.

MEASURES	(  )	FINISHES	SAP	POINTS
60x35,2x48,5 / 23 <sup>5</sup> / <sub>8</sub> x13 <sup>7</sup> / <sub>8</sub> x19 <sup>1</sup> / <sub>8</sub>		Gloss lacquer	700015112	1691
		Matt lacquer	700015168	1538
		Wood	700015056	1904
90x35,2x48,5 / 35 <sup>3</sup> / <sub>8</sub> x13 <sup>7</sup> / <sub>8</sub> x19 <sup>1</sup> / <sub>8</sub>		Gloss lacquer	700015113	1944
		Matt lacquer	700015169	1764
		Wood	700015057	2187
120x35,2x48,5 / 47 <sup>1</sup> / <sub>4</sub> x13 <sup>7</sup> / <sub>8</sub> x19 <sup>1</sup> / <sub>8</sub>		Gloss lacquer	700015114	2204
		Matt lacquer	700015170	1996
		Wood	700015058	2470

## WASH BASIN UNIT BPS-1 DX USA COMPATIBLE

DEPTH 48,5CM / 19<sup>1</sup>/<sub>8</sub>"

35,2 / 13<sup>7</sup>/<sub>8</sub>

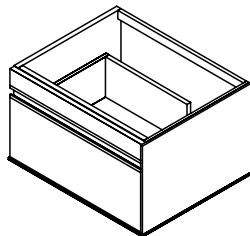

Basin unit with **NO** left side.

Base portalavabo **SENZA** spalla sinistra.

Тумбочка под умывальник БЕЗ левой боковой стороны.



MEASURES	(  )	FINISHES	SAP	POINTS
60x35,2x48,5 / 23 <sup>5</sup> / <sub>8</sub> x13 <sup>7</sup> / <sub>8</sub> x19 <sup>1</sup> / <sub>8</sub>		Gloss lacquer	700022884	1867
		Matt lacquer	700022885	1714
		Wood	700022886	2080
90x35,2x48,5 / 35 <sup>3</sup> / <sub>8</sub> x13 <sup>7</sup> / <sub>8</sub> x19 <sup>1</sup> / <sub>8</sub>		Gloss lacquer	700022908	2120
		Matt lacquer	700022909	1940
		Wood	700022910	2363
120x35,2x48,5 / 47 <sup>1</sup> / <sub>4</sub> x13 <sup>7</sup> / <sub>8</sub> x19 <sup>1</sup> / <sub>8</sub>		Gloss lacquer	700022860	2380
		Matt lacquer	700022861	2172
		Wood	700022862	2646

## WASH BASIN UNIT BPS-2C

DEPTH 48,5CM / 19<sup>1</sup>/<sub>8</sub>"

47,2 / 18<sup>5</sup>/<sub>8</sub>

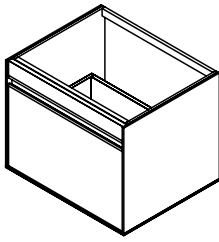

**Full** basin unit.

Base portalavabo **completa**.

Тумбочка под умывальник полностью.

MEASURES	(  )	FINISHES	SAP	POINTS
60x47,2x48,5 / 23 <sup>5</sup> / <sub>8</sub> x18 <sup>5</sup> / <sub>8</sub> x19 <sup>1</sup> / <sub>8</sub>		Gloss lacquer	700015118	1867
		Matt lacquer	700015174	1694
		Wood	700015062	2073
90x47,2x48,5 / 35 <sup>3</sup> / <sub>8</sub> x18 <sup>5</sup> / <sub>8</sub> x19 <sup>1</sup> / <sub>8</sub>		Gloss lacquer	700015119	2133
		Matt lacquer	700015175	1930
		Wood	700015063	2378
120x47,2x48,5 / 47 <sup>1</sup> / <sub>4</sub> x18 <sup>5</sup> / <sub>8</sub> x19 <sup>1</sup> / <sub>8</sub>		Gloss lacquer	700015120	2405
		Matt lacquer	700015176	2172
		Wood	700015064	2677

## WASH BASIN UNIT BPS-2C USA COMPATIBLE

DEPTH 48,5CM / 19<sup>1</sup>/<sub>8</sub>"

47,2 / 18<sup>5</sup>/<sub>8</sub>

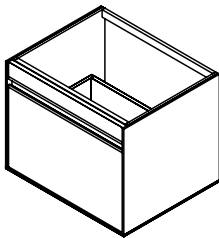

**Full** basin unit.

Base portalavabo **completa**.

Тумбочка под умывальник полностью.



MEASURES	(  )	FINISHES	SAP	POINTS
60x47,2x48,5 / 23 <sup>5</sup> / <sub>8</sub> x18 <sup>5</sup> / <sub>8</sub> x19 <sup>1</sup> / <sub>8</sub>		Gloss lacquer	700022905	1918
		Matt lacquer	700022906	1745
		Wood	700022907	2124
90x47,2x48,5 / 35 <sup>3</sup> / <sub>8</sub> x18 <sup>5</sup> / <sub>8</sub> x19 <sup>1</sup> / <sub>8</sub>		Gloss lacquer	700022929	2184
		Matt lacquer	700022930	1981
		Wood	700022931	2429
120x47,2x48,5 / 47 <sup>1</sup> / <sub>4</sub> x18 <sup>5</sup> / <sub>8</sub> x19 <sup>1</sup> / <sub>8</sub>		Gloss lacquer	700022881	2456
		Matt lacquer	700022882	2223
		Wood	700022883	2728

## WASH BASIN UNIT BPS-2 SX

DEPTH 48,5CM / 19<sup>1</sup>/<sub>8</sub>"

47,2 / 18<sup>5</sup>/<sub>8</sub>

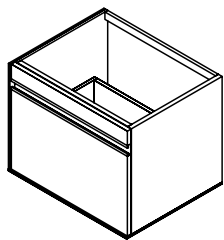

Basin unit with **NO** right side.

Base portalavabo **SENZA** spalla destra.

Тумбочка под умывальник БЕЗ правой боковой стороны.

MEASURES	(xx)	FINISHES	SAP	POINTS
60x47,2x48,5 / 23 <sup>5</sup> / <sub>8</sub> x18 <sup>5</sup> / <sub>8</sub> x19 <sup>1</sup> / <sub>8</sub>		Gloss lacquer	700015121	1784
		Matt lacquer	700015177	1613
		Wood	700015065	2014
90x47,2x48,5 / 35 <sup>3</sup> / <sub>8</sub> x18 <sup>5</sup> / <sub>8</sub> x19 <sup>1</sup> / <sub>8</sub>		Gloss lacquer	700015122	2050
		Matt lacquer	700015178	1850
		Wood	700015066	2319
120x47,2x48,5 / 47 <sup>1</sup> / <sub>4</sub> x18 <sup>5</sup> / <sub>8</sub> x19 <sup>1</sup> / <sub>8</sub>		Gloss lacquer	700015123	2322
		Matt lacquer	700015179	2092
		Wood	700015067	2617

## WASH BASIN UNIT BPS-2 SX USA COMPATIBLE

DEPTH 48,5CM / 19<sup>1</sup>/<sub>8</sub>"

47,2 / 18<sup>5</sup>/<sub>8</sub>

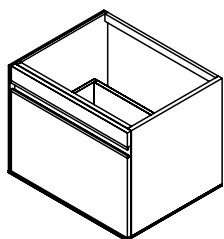

Basin unit with **NO** right side.

Base portalavabo **SENZA** spalla destra.

Тумбочка под умывальник БЕЗ правой боковой стороны.



MEASURES	(xx)	FINISHES	SAP	POINTS
60x47,2x48,5 / 23 <sup>5</sup> / <sub>8</sub> x18 <sup>5</sup> / <sub>8</sub> x19 <sup>1</sup> / <sub>8</sub>		Gloss lacquer	700022902	1835
		Matt lacquer	700022903	1664
		Wood	700022904	2065
90x47,2x48,5 / 35 <sup>3</sup> / <sub>8</sub> x18 <sup>5</sup> / <sub>8</sub> x19 <sup>1</sup> / <sub>8</sub>		Gloss lacquer	700022926	2101
		Matt lacquer	700022927	1901
		Wood	700022928	2370
120x47,2x48,5 / 47 <sup>1</sup> / <sub>4</sub> x18 <sup>5</sup> / <sub>8</sub> x19 <sup>1</sup> / <sub>8</sub>		Gloss lacquer	700022878	2373
		Matt lacquer	700022879	2143
		Wood	700022880	2668

## WASH BASIN UNIT BPS-2 DX

DEPTH 48,5CM / 19<sup>1</sup>/<sub>8</sub>"

47,2 / 18<sup>5</sup>/<sub>8</sub>

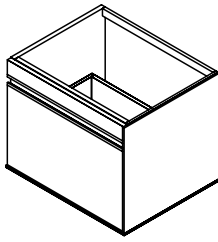

Basin unit with **NO** left side.

Base portalavabo **SENZA** spalla sinistra.

Тумбочка под умывальник БЕЗ левой боковой стороны.

MEASURES	( x  x )	FINISHES	SAP	POINTS
60x47,2x48,5 / 23 <sup>5</sup> / <sub>8</sub> x18 <sup>5</sup> / <sub>8</sub> x19 <sup>1</sup> / <sub>8</sub>		Gloss lacquer	700015124	1784
		Matt lacquer	700015180	1613
		Wood	700015068	2014
90x47,2x48,5 / 35 <sup>3</sup> / <sub>8</sub> x18 <sup>5</sup> / <sub>8</sub> x19 <sup>1</sup> / <sub>8</sub>		Gloss lacquer	700015125	2050
		Matt lacquer	700015181	1850
		Wood	700015069	2319
120x47,2x48,5 / 47 <sup>1</sup> / <sub>4</sub> x18 <sup>5</sup> / <sub>8</sub> x19 <sup>1</sup> / <sub>8</sub>		Gloss lacquer	700015126	2322
		Matt lacquer	700015182	2092
		Wood	700015070	2617

## WASH BASIN UNIT BPS-2 DX USA COMPATIBLE

DEPTH 48,5CM / 19<sup>1</sup>/<sub>8</sub>"

47,2 / 18<sup>5</sup>/<sub>8</sub>

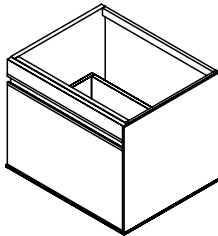

Basin unit with **NO** left side.

Base portalavabo **SENZA** spalla sinistra.

Тумбочка под умывальник БЕЗ левой боковой стороны.



MEASURES	( x  x )	FINISHES	SAP	POINTS
60x47,2x48,5 / 23 <sup>5</sup> / <sub>8</sub> x18 <sup>5</sup> / <sub>8</sub> x19 <sup>1</sup> / <sub>8</sub>		Gloss lacquer	700022896	1835
		Matt lacquer	700022897	1664
		Wood	700022898	2065
90x47,2x48,5 / 35 <sup>3</sup> / <sub>8</sub> x18 <sup>5</sup> / <sub>8</sub> x19 <sup>1</sup> / <sub>8</sub>		Gloss lacquer	700022920	2101
		Matt lacquer	700022921	1901
		Wood	700022922	2370
120x47,2x48,5 / 47 <sup>1</sup> / <sub>4</sub> x18 <sup>5</sup> / <sub>8</sub> x19 <sup>1</sup> / <sub>8</sub>		Gloss lacquer	700022872	2373
		Matt lacquer	700022873	2143
		Wood	700022874	2668

## FREESTANDING UNIT MS-1C

DEPTH 48,5CM / 19<sup>1</sup>/<sub>8</sub>"

36 / 14<sup>1</sup>/<sub>8</sub>

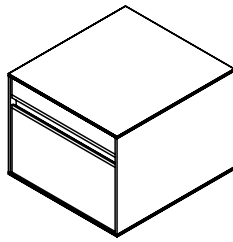

Full wall-hung module.  
Modulo sospeso **completo**.  
Настенный модуль полностью.

MEASURES	(  )	FINISHES	SAP	POINTS
45x36x48,5 / 17 <sup>3</sup> / <sub>4</sub> x14 <sup>1</sup> / <sub>8</sub> x19 <sup>1</sup> / <sub>8</sub>		Gloss lacquer	700015130	1848
		Matt lacquer	700015186	1681
		Wood	700015074	2077
60x36x48,5 / 23 <sup>5</sup> / <sub>8</sub> x14 <sup>1</sup> / <sub>8</sub> x19 <sup>1</sup> / <sub>8</sub>		Gloss lacquer	700015131	2017
		Matt lacquer	700015187	1828
		Wood	700015075	2257
90x36x48,5 / 35 <sup>3</sup> / <sub>8</sub> x14 <sup>1</sup> / <sub>8</sub> x19 <sup>1</sup> / <sub>8</sub>		Gloss lacquer	700015132	2349
		Matt lacquer	700015188	2120
		Wood	700015076	2629
120x36x48,5 / 47 <sup>1</sup> / <sub>4</sub> x14 <sup>1</sup> / <sub>8</sub> x19 <sup>1</sup> / <sub>8</sub>		Gloss lacquer	700015133	2693
		Matt lacquer	700015189	2424
		Wood	700015077	3000

## FREESTANDING UNIT MS-1 SX

DEPTH 48,5CM / 19<sup>1</sup>/<sub>8</sub>"

36 / 14<sup>1</sup>/<sub>8</sub>

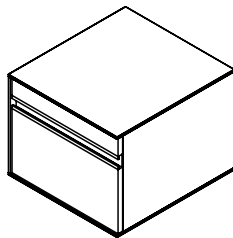

Wall-hung module with **NO** right side.  
Modulo sospeso **SENZA** spalla destra.  
Настенный модуль БЕЗ правой боковой стороны.

MEASURES	(  )	FINISHES	SAP	POINTS
45x36x48,5 / 17 <sup>3</sup> / <sub>4</sub> x14 <sup>1</sup> / <sub>8</sub> x19 <sup>1</sup> / <sub>8</sub>		Gloss lacquer	700015134	1780
		Matt lacquer	700015190	1614
		Wood	700015078	2015
60x36x48,5 / 23 <sup>5</sup> / <sub>8</sub> x14 <sup>1</sup> / <sub>8</sub> x19 <sup>1</sup> / <sub>8</sub>		Gloss lacquer	700015135	1948
		Matt lacquer	700015191	1762
		Wood	700015079	2195
90x36x48,5 / 35 <sup>3</sup> / <sub>8</sub> x14 <sup>1</sup> / <sub>8</sub> x19 <sup>1</sup> / <sub>8</sub>		Gloss lacquer	700015136	2280
		Matt lacquer	700015192	2054
		Wood	700015080	2568
120x36x48,5 / 47 <sup>1</sup> / <sub>4</sub> x14 <sup>1</sup> / <sub>8</sub> x19 <sup>1</sup> / <sub>8</sub>		Gloss lacquer	700015137	2624
		Matt lacquer	700015193	2357
		Wood	700015081	2938

## FREESTANDING UNIT MS-1 DX

DEPTH 48,5CM / 19<sup>1</sup>/<sub>8</sub>"

36 / 14<sup>1</sup>/<sub>8</sub>

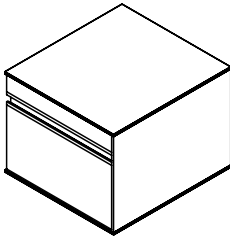

Wall-hung module with **NO** left side.

Modulo sospeso **SENZA** spalla sinistra.

Настенный модуль БЕЗ левой боковой стороны.

MEASURES	(  )	FINISHES	SAP	POINTS
45x36x48,5 / 17 <sup>3</sup> / <sub>4</sub> x14 <sup>1</sup> / <sub>8</sub> x19 <sup>1</sup> / <sub>8</sub>		Gloss lacquer	700015138	1780
		Matt lacquer	700015194	1614
		Wood	700015082	2015
60x36x48,5 / 23 <sup>5</sup> / <sub>8</sub> x14 <sup>1</sup> / <sub>8</sub> x19 <sup>1</sup> / <sub>8</sub>		Gloss lacquer	700015139	1948
		Matt lacquer	700015195	1762
		Wood	700015083	2195
90x36x48,5 / 35 <sup>3</sup> / <sub>8</sub> x14 <sup>1</sup> / <sub>8</sub> x19 <sup>1</sup> / <sub>8</sub>		Gloss lacquer	700015140	2280
		Matt lacquer	700015196	2054
		Wood	700015084	2568
120x36x48,5 / 47 <sup>1</sup> / <sub>4</sub> x14 <sup>1</sup> / <sub>8</sub> x19 <sup>1</sup> / <sub>8</sub>		Gloss lacquer	700015141	2624
		Matt lacquer	700015197	2357
		Wood	700015085	2938

## FREESTANDING UNIT MS-1

DEPTH 48,5CM / 19<sup>1</sup>/<sub>8</sub>"

36 / 14<sup>1</sup>/<sub>8</sub>

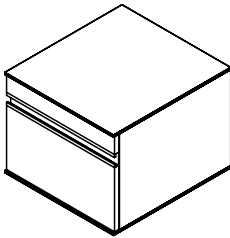

Wall-hung module with **NO** sides.

Modulo sospeso **SENZA** fianchi.

Настенный модуль БЕЗ боковых сторон.

MEASURES	(  )	FINISHES	SAP	POINTS
45x36x48,5 / 17 <sup>3</sup> / <sub>4</sub> x14 <sup>1</sup> / <sub>8</sub> x19 <sup>1</sup> / <sub>8</sub>		Gloss lacquer	700015142	1711
		Matt lacquer	700015198	1548
		Wood	700015086	1954
60x36x48,5 / 23 <sup>5</sup> / <sub>8</sub> x14 <sup>1</sup> / <sub>8</sub> x19 <sup>1</sup> / <sub>8</sub>		Gloss lacquer	700015143	1879
		Matt lacquer	700015199	1696
		Wood	700015087	2134
90x36x48,5 / 35 <sup>3</sup> / <sub>8</sub> x14 <sup>1</sup> / <sub>8</sub> x19 <sup>1</sup> / <sub>8</sub>		Gloss lacquer	700015144	2211
		Matt lacquer	700015200	1988
		Wood	700015088	2506
120x36x48,5 / 47 <sup>1</sup> / <sub>4</sub> x14 <sup>1</sup> / <sub>8</sub> x19 <sup>1</sup> / <sub>8</sub>		Gloss lacquer	700015145	2555
		Matt lacquer	700015201	2291
		Wood	700015089	2877

## FREESTANDING UNIT MS-2C

DEPTH 48,5CM / 19<sup>1</sup>/<sub>8</sub>"

48 / 18<sup>7</sup>/<sub>8</sub>

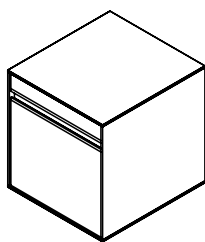

Full wall-hung module.

Modulo sospeso **completo**.

Настенный модуль полностью.

MEASURES	(  )	FINISHES	SAP	POINTS
45x48x48,5 / 17 <sup>3</sup> / <sub>4</sub> x18 <sup>7</sup> / <sub>8</sub> x19 <sup>1</sup> / <sub>8</sub>		Gloss lacquer	700015146	1959
		Matt lacquer	700015202	1774
		Wood	700015090	2189
60x48x48,5 / 23 <sup>5</sup> / <sub>8</sub> x18 <sup>7</sup> / <sub>8</sub> x19 <sup>1</sup> / <sub>8</sub>		Gloss lacquer	700015147	2137
		Matt lacquer	700015203	1930
		Wood	700015091	2379
90x48x48,5 / 35 <sup>3</sup> / <sub>8</sub> x18 <sup>7</sup> / <sub>8</sub> x19 <sup>1</sup> / <sub>8</sub>		Gloss lacquer	700015148	2483
		Matt lacquer	700015204	2233
		Wood	700015092	2774
120x48x48,5 / 47 <sup>1</sup> / <sub>4</sub> x18 <sup>7</sup> / <sub>8</sub> x19 <sup>1</sup> / <sub>8</sub>		Gloss lacquer	700015149	2839
		Matt lacquer	700015205	2546
		Wood	700015093	3161

## FREESTANDING UNIT MS-2 SX

DEPTH 48,5CM / 19<sup>1</sup>/<sub>8</sub>"

48 / 18<sup>7</sup>/<sub>8</sub>

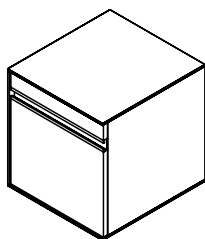

Wall-hung module with **NO** right side.

Modulo sospeso **SENZA** spalla destra.

Настенный модуль БЕЗ правой боковой стороны.

MEASURES	(  )	FINISHES	SAP	POINTS
45x48x48,5 / 17 <sup>3</sup> / <sub>4</sub> x18 <sup>7</sup> / <sub>8</sub> x19 <sup>1</sup> / <sub>8</sub>		Gloss lacquer	700015150	1874
		Matt lacquer	700015206	1693
		Wood	700015094	2126
60x48x48,5 / 23 <sup>5</sup> / <sub>8</sub> x18 <sup>7</sup> / <sub>8</sub> x19 <sup>1</sup> / <sub>8</sub>		Gloss lacquer	700015151	2052
		Matt lacquer	700015207	1848
		Wood	700015095	2317
90x48x48,5 / 35 <sup>3</sup> / <sub>8</sub> x18 <sup>7</sup> / <sub>8</sub> x19 <sup>1</sup> / <sub>8</sub>		Gloss lacquer	700015152	2398
		Matt lacquer	700015208	2151
		Wood	700015096	2711
120x48x48,5 / 47 <sup>1</sup> / <sub>4</sub> x18 <sup>7</sup> / <sub>8</sub> x19 <sup>1</sup> / <sub>8</sub>		Gloss lacquer	700015153	2754
		Matt lacquer	700015209	2464
		Wood	700015097	3098



## FREESTANDING UNIT MS-2 DX

DEPTH 48,5CM / 19<sup>1</sup>/<sub>8</sub>"

48 / 18<sup>7</sup>/<sub>8</sub>

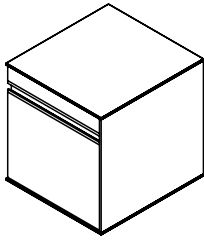

Wall-hung module with **NO** left side.

Modulo sospeso **SENZA** spalla sinistra.

Настенный модуль БЕЗ левой боковой стороны.

MEASURES	(  )	FINISHES	SAP	POINTS
45x48x48,5 / 17 <sup>3</sup> / <sub>4</sub> x18 <sup>7</sup> / <sub>8</sub> x19 <sup>1</sup> / <sub>8</sub>		Gloss lacquer	700015154	1874
		Matt lacquer	700015210	1693
		Wood	700015098	2126
60x48x48,5 / 23 <sup>5</sup> / <sub>8</sub> x18 <sup>7</sup> / <sub>8</sub> x19 <sup>1</sup> / <sub>8</sub>		Gloss lacquer	700015155	2052
		Matt lacquer	700015211	1848
		Wood	700015099	2317
90x48x48,5 / 35 <sup>3</sup> / <sub>8</sub> x18 <sup>7</sup> / <sub>8</sub> x19 <sup>1</sup> / <sub>8</sub>		Gloss lacquer	700015156	2398
		Matt lacquer	700015212	2151
		Wood	700015100	2711
120x48x48,5 / 47 <sup>1</sup> / <sub>4</sub> x18 <sup>7</sup> / <sub>8</sub> x19 <sup>1</sup> / <sub>8</sub>		Gloss lacquer	700015157	2754
		Matt lacquer	700015213	2464
		Wood	700015101	3098

## FREESTANDING UNIT MS-2

DEPTH 48,5CM / 19<sup>1</sup>/<sub>8</sub>"

48 / 18<sup>7</sup>/<sub>8</sub>

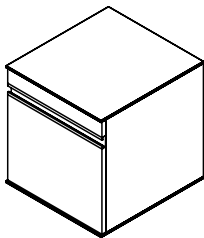

Wall-hung module with **NO** sides.

Modulo sospeso **SENZA** fianchi.

Настенный модуль БЕЗ боковых сторон.

MEASURES	(  )	FINISHES	SAP	POINTS
45x48x48,5 / 17 <sup>3</sup> / <sub>4</sub> x18 <sup>7</sup> / <sub>8</sub> x19 <sup>1</sup> / <sub>8</sub>		Gloss lacquer	700015158	1789
		Matt lacquer	700015214	1611
		Wood	700015102	2063
60x48x48,5 / 23 <sup>5</sup> / <sub>8</sub> x18 <sup>7</sup> / <sub>8</sub> x19 <sup>1</sup> / <sub>8</sub>		Gloss lacquer	700015159	1967
		Matt lacquer	700015215	1766
		Wood	700015103	2254
90x48x48,5 / 35 <sup>3</sup> / <sub>8</sub> x18 <sup>7</sup> / <sub>8</sub> x19 <sup>1</sup> / <sub>8</sub>		Gloss lacquer	700015160	2312
		Matt lacquer	700015216	2069
		Wood	700015104	2648
120x48x48,5 / 47 <sup>1</sup> / <sub>4</sub> x18 <sup>7</sup> / <sub>8</sub> x19 <sup>1</sup> / <sub>8</sub>		Gloss lacquer	700015161	2669
		Matt lacquer	700015217	2382
		Wood	700015105	3035

## UPPER UNIT

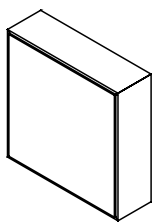

Upper unit with door.  
Modulo pensile con anta  
Верхний блок с дверцей.

MEASURES	(  )	FINISHES	SAP	POINTS
45x48x18 / 17 <sup>3/4</sup> x18 <sup>7/8</sup> x7 <sup>1/8</sup>		Metal / Gloss lacquer	700015278	708
		Metal / Matt lacquer	700015279	688
		Metal / Wood	700015277	731
45x60x18 / 17 <sup>3/4</sup> x23 <sup>5/8</sup> x7 <sup>1/8</sup>		Metal / Gloss lacquer	700015294	767
		Metal / Matt lacquer	700015296	742
		Metal / Wood	700015292	794
60x60x18 / 23 <sup>5/8</sup> x23 <sup>5/8</sup> x7 <sup>1/8</sup>		Metal / Gloss lacquer	700015295	859
		Metal / Matt lacquer	700015420	828
		Metal / Wood	700015293	887

## UPPER UNIT / MIRROR

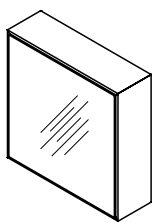

Upper unit with door. / Mirror.  
Modulo pensile con anta / Specchio.  
Верхний блок с дверцей. / Зеркало.

MEASURES	(  )	FINISHES	SAP	POINTS
45x48x18 / 17 <sup>3/4</sup> x18 <sup>7/8</sup> x7 <sup>1/8</sup>			700018270	527
45x60x18 / 17 <sup>3/4</sup> x23 <sup>5/8</sup> x7 <sup>1/8</sup>		Metal / Mirror	700018290	544
60x60x18 / 23 <sup>5/8</sup> x23 <sup>5/8</sup> x7 <sup>1/8</sup>			700018274	621

## UPPER UNIT

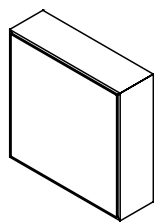

Upper unit with door.  
Modulo pensile con anta  
Верхний блок с дверцей.

MEASURES		FINISHES	SAP	POINTS
45x48x18 / 17 <sup>3/4</sup> x18 <sup>7/8</sup> x7 <sup>1/8</sup>		Metal / Gloss lacquer	700015284	732
		Metal / Matt lacquer	700015288	712
		Metal / Wood	700015280	748
60x48x18 / 23 <sup>5/8</sup> x18 <sup>7/8</sup> x7 <sup>1/8</sup>		Metal / Gloss lacquer	700015285	815
		Metal / Matt lacquer	700015289	789
		Metal / Wood	700015281	837
90x48x18 / 35 <sup>3/8</sup> x18 <sup>7/8</sup> x7 <sup>1/8</sup>		Metal / Gloss lacquer	700015286	992
		Metal / Matt lacquer	700015290	956
		Metal / Wood	700015282	1027
120x48x18 / 47 <sup>1/4</sup> x18 <sup>7/8</sup> x7 <sup>1/8</sup>		Metal / Gloss lacquer	700015287	1170
		Metal / Matt lacquer	700015291	1122
		Metal / Wood	700015283	1216
45x60x18 / 17 <sup>3/4</sup> x23 <sup>5/8</sup> x7 <sup>1/8</sup>		Metal / Gloss lacquer	700015300	806
		Metal / Matt lacquer	700015303	781
		Metal / Wood	700015297	834
60x60x18 / 23 <sup>5/8</sup> x23 <sup>5/8</sup> x7 <sup>1/8</sup>		Metal / Gloss lacquer	700015301	898
		Metal / Matt lacquer	700015304	867
		Metal / Wood	700015298	927
90x60x18 / 35 <sup>3/8</sup> x23 <sup>5/8</sup> x7 <sup>1/8</sup>		Metal / Gloss lacquer	700015302	1086
		Metal / Matt lacquer	700015305	1041
		Metal / Wood	700015299	1129

## UPPER UNIT / MIRROR

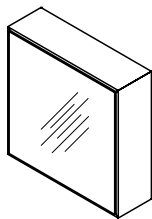

Upper unit with door. / Mirror.  
Modulo pensile con anta / Specchio.  
Верхний блок с дверцей. / Зеркало.

MEASURES		FINISHES	SAP	POINTS
45x48x18 / 17 <sup>3/4</sup> x18 <sup>7/8</sup> x7 <sup>1/8</sup>			700018263	593
60x48x18 / 23 <sup>5/8</sup> x18 <sup>7/8</sup> x7 <sup>1/8</sup>			700018264	624
90x48x18 / 35 <sup>3/8</sup> x18 <sup>7/8</sup> x7 <sup>1/8</sup>			700018275	711
120x48x18 / 47 <sup>1/4</sup> x18 <sup>7/8</sup> x7 <sup>1/8</sup>		Metal / Mirror	700018261	785
45x60x18 / 17 <sup>3/4</sup> x23 <sup>5/8</sup> x7 <sup>1/8</sup>			700018273	630
60x60x18 / 23 <sup>5/8</sup> x23 <sup>5/8</sup> x7 <sup>1/8</sup>			700018282	708
90x60x18 / 35 <sup>3/8</sup> x23 <sup>5/8</sup> x7 <sup>1/8</sup>			700018284	739

## SHELF

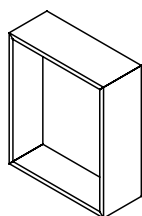

Shelf.  
Ripiano.  
Полка.

MEASURES		FINISHES	SAP	POINTS
45x36x12 / 17 <sup>3/4</sup> x14 <sup>1/8</sup> x4 <sup>3/4</sup>		Metal / Gloss lacquer	700015228	334
		Metal / Matt lacquer	700015230	304
		Metal / Wood	700015226	416
45x48x12 / 17 <sup>3/4</sup> x18 <sup>7/8</sup> x4 <sup>3/4</sup>		Metal / Gloss lacquer	700015229	375
		Metal / Matt lacquer	700015231	335
		Metal / Wood	700015227	463

## SHELF / MIRROR

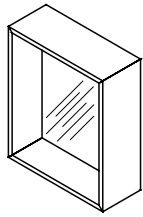

Shelf / Mirror.  
Mensola/ Specchio.  
Полка / зеркало.

MEASURES	(xx)	FINISHES	SAP	POINTS
45x36x9	$17\frac{3}{4} \times 14\frac{1}{8} \times 3\frac{1}{2}$	Metal / Mirror	700015218	241
60x36x9	$23\frac{5}{8} \times 14\frac{1}{8} \times 3\frac{1}{2}$		700015219	264
90x36x9	$35\frac{3}{8} \times 14\frac{1}{8} \times 3\frac{1}{2}$		100160323	268
120x36x9	$47\frac{1}{4} \times 14\frac{1}{8} \times 3\frac{1}{2}$		700015221	359
45x48x9	$17\frac{3}{4} \times 18\frac{7}{8} \times 3\frac{1}{2}$		700015222	262
60x48x9	$23\frac{5}{8} \times 18\frac{7}{8} \times 3\frac{1}{2}$		700015223	287
90x48x9	$35\frac{3}{8} \times 18\frac{7}{8} \times 3\frac{1}{2}$		700015224	338
120x48x9	$47\frac{1}{4} \times 18\frac{7}{8} \times 3\frac{1}{2}$		700015225	390

MA

## TALL CABINET MSC-3 WITHOUT DOOR FRONT

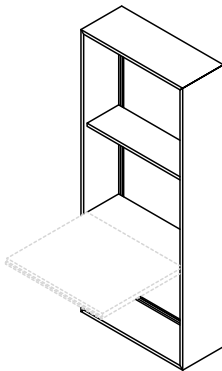

Tall cabinet. Front is required.  
Colonna. Bisogna antina.  
Высокий шкаф. Нуждается в фасаде.

MEASURES	(xx)	FINISHES	SAP	POINTS
30x108x18	$11\frac{3}{4} \times 42\frac{1}{2} \times 7\frac{1}{8}$	Metal / Gloss lacquer	700015238	640
		Metal / Matt lacquer	700015240	599
		Metal / Wood	700015236	749
45x108x18	$17\frac{3}{4} \times 42\frac{1}{2} \times 7\frac{1}{8}$	Metal / Gloss lacquer	700015239	733
		Metal / Matt lacquer	700015241	668
		Metal / Wood	700015237	864

dless

## TALL CABINET FRONT MSC-3

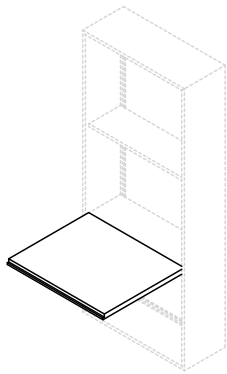

Door Front.  
Porta colonna  
Фасад высокого шкафа.

MEASURES	( x  x )	FINISHES	SAP	POINTS
30x36x2 / 11 <sup>3/4</sup> x14 <sup>1/8</sup> x0 <sup>3/4</sup>		Gloss lacquer	700015244	385
		Matt lacquer	700015246	359
		Wood	700015242	448
45x36x2 / 17 <sup>3/4</sup> x14 <sup>1/8</sup> x0 <sup>3/4</sup>		Gloss lacquer	700015245	426
		Matt lacquer	700015247	397
		Wood	700015243	498

## TALL CABINET MSC-2 WITHOUT DOOR FRONT

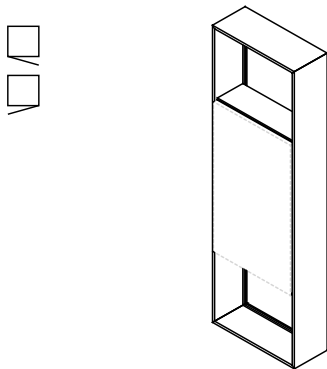

Tall cabinet. Front is required.  
Colonna. Bisogna antina.  
Высокий шкаф. Нуждается в фасаде.

MEASURES	( x  x )	FINISHES	SAP	POINTS
30x144x18 / 11 <sup>3/4</sup> x56 <sup>3/4</sup> x7 <sup>1/8</sup>		Metal / Gloss lacquer	700015250	808
		Metal / Matt lacquer	700015252	757
		Metal / Wood	700015248	954
45x144x18 / 17 <sup>3/4</sup> x56 <sup>3/4</sup> x7 <sup>1/8</sup>		Metal / Gloss lacquer	700015251	912
		Metal / Matt lacquer	700015253	848
		Metal / Wood	700015249	1084

## TALL CABINET FRONT MSC-2

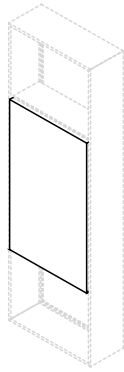

Door Front.  
Porta colonna  
Фасад высокого шкафа.

MEASURES 	FINISHES	SAP	POINTS
30x73x2 / 11 <sup>3/4</sup> x28 <sup>3/4</sup> x0 <sup>3/4</sup>	Gloss lacquer	700015256	301
	Matt lacquer	700015258	280
	Wood	700015254	338
45x73x2 / 17 <sup>3/4</sup> x28 <sup>3/4</sup> x0 <sup>3/4</sup>	Gloss lacquer	700015257	362
	Matt lacquer	700015259	332
	Wood	700015255	410

## TALL CABINET MSC

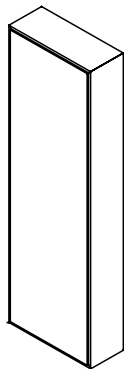
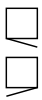

Tall cabinet push-to-open.  
Colonna apertura Push.  
Высокий шкаф с механизмом «нажал-открылось».

MEASURES 	FINISHES	SAP	POINTS
30x144x18 / 11 <sup>3/4</sup> x56 <sup>3/4</sup> x7 <sup>1/8</sup>	Metal / Gloss lacquer	700015264	1132
	Metal / Matt lacquer	700015266	1097
	Metal / Wood	700015262	1168
	Metal / Mirror	700015260	1188
45x144x18 / 17 <sup>3/4</sup> x56 <sup>3/4</sup> x7 <sup>1/8</sup>	Metal / Gloss lacquer	700015265	1302
	Metal / Matt lacquer	700015267	1249
	Metal / Wood	700015263	1354
	Metal / Mirror	700015261	1284

## TALL CABINET

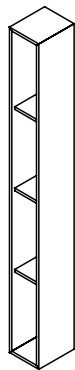

Tall cabinet.  
Colonna.  
Высокий шкаф..

MC

MEASURES	FINISHES	SAP	POINTS
15x144x18 / 5 <sup>7/8</sup> x56 <sup>3/4</sup> x7 <sup>1/8</sup>	Metal / Gloss lacquer	700015271	687
	Metal / Matt lacquer	700015274	650
	Metal / Wood	700015268	771
30x144x18 / 11 <sup>3/4</sup> x56 <sup>3/4</sup> x7 <sup>1/8</sup>	Metal / Gloss lacquer	700015272	792
	Metal / Matt lacquer	700015275	742
	Metal / Wood	700015269	939
45x144x18 / 17 <sup>3/4</sup> x56 <sup>3/4</sup> x7 <sup>1/8</sup>	Metal / Gloss lacquer	700015273	914
	Metal / Matt lacquer	700015276	833
	Metal / Wood	700015270	1090

## MIRROR CICLO

DEPTH 4,5CM / 1<sup>3/4</sup>"

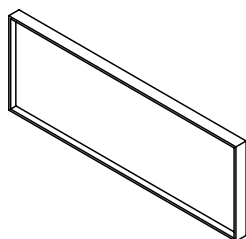

Mirror.  
Specchio  
Зеркало.

ES

MEASURES	FINISHES	SAP	POINTS
60x36x4,5 / 23 <sup>5/8</sup> x14 <sup>1/8</sup> x1 <sup>3/4</sup>	Metal	100138790	217
90x36x4,5 / 35 <sup>3/8</sup> x14 <sup>1/8</sup> x1 <sup>3/4</sup>	Metal	100138792	260
120x36x4,5 / 47 <sup>1/4</sup> x14 <sup>1/8</sup> x1 <sup>3/4</sup>	Metal	100138774	305
150x36x4,5 / 59x14 <sup>1/8</sup> x1 <sup>3/4</sup>	Metal	100138776	356
180x36x4,5 / 70 <sup>7/8</sup> x14 <sup>1/8</sup> x1 <sup>3/4</sup>	Metal	100138778	407
60x48x4,5 / 23 <sup>5/8</sup> x18 <sup>7/8</sup> x1 <sup>3/4</sup>	Metal	100138791	241
90x48x4,5 / 35 <sup>3/8</sup> x18 <sup>7/8</sup> x1 <sup>3/4</sup>	Metal	100138793	291
120x48x4,5 / 47 <sup>1/4</sup> x18 <sup>7/8</sup> x1 <sup>3/4</sup>	Metal	100138775	344
150x48x4,5 / 59x18 <sup>7/8</sup> x1 <sup>3/4</sup>	Metal	100138777	401
180x48x4,5 / 70 <sup>7/8</sup> x18 <sup>7/8</sup> x1 <sup>3/4</sup>	Metal	100138779	458



## MIRROR CICLO

DEPTH 4,5CM / 1<sup>3/4</sup>"

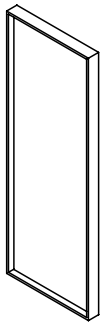

Mirror.  
Specchio  
Зеркало.

MEASURES	FINISHES	SAP	POINTS
36x60x4,5 / 14 <sup>1/8</sup> x23 <sup>5/8</sup> x1 <sup>3/4</sup>	Metal	100145431	217
36x90x4,5 / 14 <sup>1/8</sup> x35 <sup>3/8</sup> x1 <sup>3/4</sup>	Metal	100145432	260
36x120x4,5 / 14 <sup>1/8</sup> x47 <sup>1/4</sup> x1 <sup>3/4</sup>	Metal	100145408	305
36x150x4,5 / 14 <sup>1/8</sup> x59x1 <sup>3/4</sup>	Metal	100145409	356
36x180x4,5 / 14 <sup>1/8</sup> x70 <sup>7/8</sup> x1 <sup>3/4</sup>	Metal	100145430	407
48x60x4,5 / 18 <sup>7/8</sup> x23 <sup>5/8</sup> x1 <sup>3/4</sup>	Metal	100145436	241
48x90x4,5 / 18 <sup>7/8</sup> x35 <sup>3/8</sup> x1 <sup>3/4</sup>	Metal	100145437	291
48x120x4,5 / 18 <sup>7/8</sup> x47 <sup>1/4</sup> x1 <sup>3/4</sup>	Metal	100145433	344
48x150x4,5 / 18 <sup>7/8</sup> x59x1 <sup>3/4</sup>	Metal	100145434	401
48x180x4,5 / 18 <sup>7/8</sup> x70 <sup>7/8</sup> x1 <sup>3/4</sup>	Metal	100145435	458

## MIRROR WITH LIGHT

DEPTH 9CM / 3<sup>1/2</sup>"

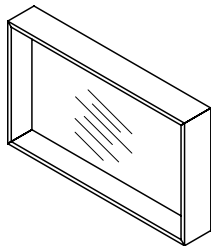

Mirror with light.  
Specchio con illuminazione.  
Зеркало с подсветкой.



Light SX.

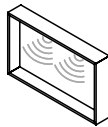

Light N.

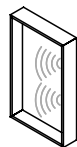

Light DX.

MEASURES	FINISHES	SAP	POINTS
60x36x9 / 23 <sup>5/8</sup> x14 <sup>1/8</sup> x3 <sup>1/2</sup>		700019730	685
90x36x9 / 35 <sup>3/8</sup> x14 <sup>1/8</sup> x3 <sup>1/2</sup>	Metal	700019731	752
120x36x9 / 47 <sup>1/4</sup> x14 <sup>1/8</sup> x3 <sup>1/2</sup>		700019732	823
60x48x9 / 23 <sup>5/8</sup> x18 <sup>7/8</sup> x3 <sup>1/2</sup>		700019736	699
90x48x9 / 35 <sup>3/8</sup> x18 <sup>7/8</sup> x3 <sup>1/2</sup>	Metal	700019737	773
120x48x9 / 47 <sup>1/4</sup> x18 <sup>7/8</sup> x3 <sup>1/2</sup>		700019738	846
60x60x9 / 23 <sup>5/8</sup> x23 <sup>5/8</sup> x3 <sup>1/2</sup>		700019742	728
90x60x9 / 35 <sup>3/8</sup> x23 <sup>5/8</sup> x3 <sup>1/2</sup>	Metal	700019743	793
120x60x9 / 47 <sup>1/4</sup> x23 <sup>5/8</sup> x3 <sup>1/2</sup>		700019744	871

## ACCESSORY-HOLDER ROD

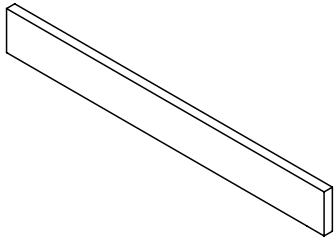

Accessory-holder rod.

Barra portaaccessori.

Стержень-держатель аксессуаров.

MEASURES	(  )	FINISHES	SAP	POINTS
30x9x5	/ 11 <sup>3/4</sup> x3 <sup>1/2</sup> x2	Gloss lacquer	700029921	214
		Matt lacquer	700029935	185
		Wood	700029942	267
45x9x5	/ 17 <sup>3/4</sup> x3 <sup>1/2</sup> x2	Gloss lacquer	700029970	233
		Matt lacquer	700029922	201
		Wood	700029961	290
60x9x5	/ 23 <sup>5/8</sup> x3 <sup>1/2</sup> x2	Gloss lacquer	700015390	251
		Matt lacquer	700015397	217
		Wood	700015383	313
90x9x5	/ 35 <sup>3/8</sup> x3 <sup>1/2</sup> x2	Gloss lacquer	700015391	312
		Matt lacquer	700015398	267
		Wood	700015384	394
120x9x5	/ 47 <sup>1/4</sup> x3 <sup>1/2</sup> x2	Gloss lacquer	700015392	368
		Matt lacquer	700015399	319
		Wood	700015385	444
150x9x5	/ 59x3 <sup>1/2</sup> x2	Gloss lacquer	700015393	426
		Matt lacquer	700015400	369
		Wood	700015386	515
180x9x5	/ 70 <sup>7/8</sup> x3 <sup>1/2</sup> x2	Gloss lacquer	700015394	475
		Matt lacquer	700015401	416
		Wood	700015387	565
210x9x5	/ 82 <sup>5/8</sup> x3 <sup>1/2</sup> x2	Gloss lacquer	700015395	530
		Matt lacquer	700015402	463
		Wood	700015388	642
240x9x5	/ 94 <sup>1/2</sup> x3 <sup>1/2</sup> x2	Gloss lacquer	700015396	581
		Matt lacquer	700015403	508
		Wood	700015389	705

## SHELF

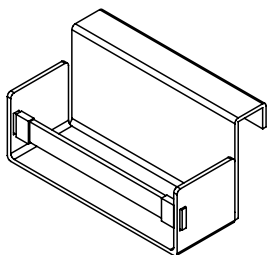

MEASURES	FINISHES	SAP	POINTS
24x13x12 / 9 <sup>1</sup> / <sub>2</sub> x5 <sup>1</sup> / <sub>8</sub> x4 <sup>3</sup> / <sub>4</sub>	Metal/Leather	100136305	181

## SHELF WITH POTS

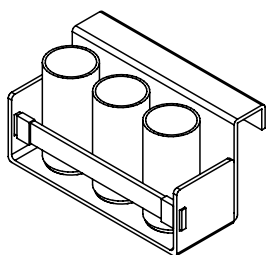

MEASURES	FINISHES	SAP	POINTS
24x13x12 / 9 <sup>1</sup> / <sub>2</sub> x5 <sup>1</sup> / <sub>8</sub> x4 <sup>3</sup> / <sub>4</sub>	Metal/Krion/Leather	100136306	379

## CIRCULAR TOWEL RACK

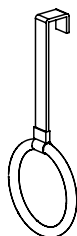

MEASURES	FINISHES	SAP	POINTS
16x36x4 / 6 <sup>1</sup> / <sub>4</sub> x14 <sup>1</sup> / <sub>8</sub> x1 <sup>5</sup> / <sub>8</sub>	Metal/Leather	100136307	117

## FLAT TOWEL RACK

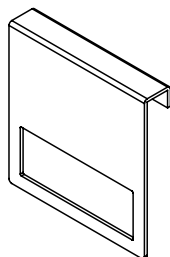

MEASURES	FINISHES	SAP	POINTS
24x24x3,6 / 9 <sup>1</sup> / <sub>2</sub> x9 <sup>1</sup> / <sub>2</sub> x1 <sup>3</sup> / <sub>8</sub>	Metal	100136308	101

## ACCESSORY-HOLDER SHELF

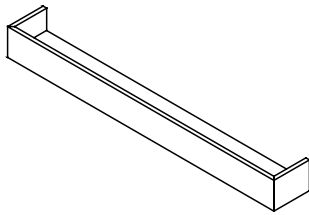

Accessory-holder shelf.  
Mensola porta accessori.  
Полка-держатель аксессуаров.

MEASURES	(xx)	FINISHES	SAP	POINTS
30x9x12	11 <sup>3/4</sup> x3 <sup>1/2</sup> x4 <sup>3/4</sup>	Metal / Krypton	700029960	186
45x9x12	17 <sup>3/4</sup> x3 <sup>1/2</sup> x4 <sup>3/4</sup>		100176532	190
60x9x12	23 <sup>5/8</sup> x3 <sup>1/2</sup> x4 <sup>3/4</sup>		100160321	214
90x9x12	35 <sup>3/8</sup> x3 <sup>1/2</sup> x4 <sup>3/4</sup>		700015234	260
120x9x12	47 <sup>1/4</sup> x3 <sup>1/2</sup> x4 <sup>3/4</sup>		700015235	311

## POT

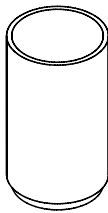

Pot.  
Bidone  
Металлический стаканчик

MEASURES	(xx)	FINISHES	SAP	POINTS
6x10x6	2 <sup>3/8</sup> x3 <sup>7/8</sup> x2 <sup>3/8</sup>	Metal	100157824	56

## NEW DESS BASIN

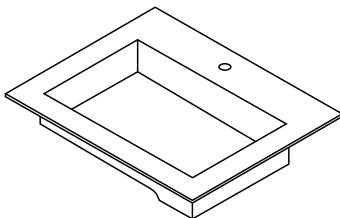

-GELCOAT basin.  
-Requires for installation permanent valve SAP100104178, 59 P.  
-Requires drainage SAP100138072, 40 P.  
-Lavabo GELCOAT.  
-Richiede valvola SAP100104178, 59 P.  
-Richiede scarico SAP100138072, 40 P.  
-Раковина GELCOAT.  
-Требуется установка постоянного клапана SAP100104178, 59 P.  
-Требуется дренаж SAP100138072, 40 P.



MEASURES	(xx)	FINISHES	SAP	POINTS
60,2x13,2x48,5	23 <sup>3/4</sup> x5 <sup>1/4</sup> x19 <sup>1/8</sup>	GELCOAT / SG	100221192	469
		GELCOAT / 1G	100221191	469
90,2x13,2x48,5	35 <sup>1/2</sup> x5 <sup>1/4</sup> x19 <sup>1/8</sup>	GELCOAT / SG	100221194	561
		GELCOAT / 1G	100221193	561
120,2x13,2x48,5	47 <sup>3/8</sup> x5 <sup>1/4</sup> x19 <sup>1/8</sup>	GELCOAT / SG	100221196	675
		GELCOAT / 1G	100221195	675

# highline



The interpretation made in inches for the dimensions of the different items shown in the price list has been rounded to 1/8, however for a more accurate measurement please use millimetres or centimetres.

## Ciclo

<b>EXTERIOR FINISHES</b> FINITURE ESTERNE ОТДЕЛКА ДЛЯ НАРУЖНОГО ИСПОЛЬЗОВАНИЯ	<input type="checkbox"/> Laminate Laminato ЛАМИНАТ	<input checked="" type="checkbox"/> Matt lacquer Laccato opaco МАТОВЫЙ ЛАК	<input checked="" type="checkbox"/> Wood veneer Legno ДЕРЕВО
	<input type="checkbox"/> HPL Stratificato СЛОИСТАЯ	<input checked="" type="checkbox"/> Gloss lacquer Laccato lucido ГЛЯНЦЕВЫЙ ЛАК	
<b>INTERIOR FINISHES</b> FINITURE INTERNE ОТДЕЛКА ДЛЯ ВНУТРЕННЕГО ИСПОЛЬЗОВАНИЯ	<input type="checkbox"/> Laminate Laminato ЛАМИНАТ	<input type="checkbox"/> Wood veneer Legno ДЕРЕВО	<input checked="" type="checkbox"/> Aluminium+laminated base Alluminio + base in laminato Алюминий + основа из ламината
	<input checked="" type="checkbox"/> Front handle Maniglia frontale a vista Декоративная передняя ручка	<input type="checkbox"/> Integrated metal handle Maniglia metallica integrata Встроенная металлическая ручка	<input type="checkbox"/> Integrated mechanized h. Maniglia integrata ricavata sul bordo Встроенная ручка по краю
<b>HANDLES</b> MANIGLIE РУЧКИ	<input type="checkbox"/> Push handle Maniglia Push РУЧКИ Push		
<b>TYPE OF UNITS</b> TIPI DI MODULI ТИПЫ МОДУЛЕЙ	<input checked="" type="checkbox"/> Compact Compatto Компактная	<input checked="" type="checkbox"/> Modular Modulare Модульная	
<b>POSITION</b> POSIZIONE ПОЗИЦИЯ	<input checked="" type="checkbox"/> Wall-mounted Sospeso Подвесная	<input type="checkbox"/> Floor-mounted A terra Напольная	
<b>MEASURES (CM)</b> DIMENSIONI РАЗМЕРЫ	◀ 60 / 90 / 120 23 <sup>5/8</sup> / 35 <sup>3/8</sup> / 47 <sup>1/4</sup>	▲ 36 14 <sup>1/8</sup>	▶ 48 18 <sup>7/8</sup>
<b>WORKTOP &amp; BASIN OPTIONS</b> OPZIONI TOP E LAVABI ВАРИАНТЫ СТОЛЕШНИЦ И УМЫВАЛЬНЫХ РАКОВИН	<input checked="" type="checkbox"/> Bath serie's worktop / basin Lavabo / top della serie Серийная умывальная раковина / столешница	<input type="checkbox"/> Standard worktops Top standard Стандартные столешницы	<input checked="" type="checkbox"/> Worktop + integrated basin Encimera + lavabo integrato Столешница + встроенная умывальная раковина
	<input checked="" type="checkbox"/> Over-mounted basin Lavabo da appoggio Настольная умывальная раковина	<input checked="" type="checkbox"/> Under-mounted basin Lavabo sottopiano Умывальная раковина, встраиваемая в столешницу снизу	<input type="checkbox"/> Double basin as option Opzione doppia vasca Вариант с двойной чашей
<b>WORKTOP FINISHES</b> FINITURE TOP ОТДЕЛКА СТОЛЕШНИЦ	<input checked="" type="checkbox"/> Krion® worktop Top in KRION® Столешница KRION®	<input type="checkbox"/> Gel Coat worktop Top in Gel Coat Столешница с покрытием гелькоут	<input checked="" type="checkbox"/> Natural Stone worktop Top in pietra naturale Столешница из натурального камня.
	<input type="checkbox"/> Glass worktop Top in vetro Столешница из стекла	<input checked="" type="checkbox"/> Bath furniture finish worktop Top con la finitura del mobile Столешница с той же отделкой, что и консоль/тумба	
<b>BASIN FINISHES</b> FINITURE LAVABI ОТДЕЛКА УМЫВАЛЬНЫХ РАКОВИН	<input checked="" type="checkbox"/> Krion® basin Lavabo in Krion® Умывальная раковина из Krion®	<input checked="" type="checkbox"/> Gel Coat basin Lavabo Gelcoat Раковина Gelcoat	<input type="checkbox"/> Ceramic basin Lavabo in ceramica Керамическая умывальная раковина
	<input type="checkbox"/> Natural Stone basin Lavabo in pietra naturale Умывальная раковина из натурального камня.		
<b>ACCESSORIES</b> ACCESSORI АКСЕССУАРЫ	<input checked="" type="checkbox"/> Mirror Specchio Зеркало	<input checked="" type="checkbox"/> Wall-mounted module Modulo sospeso Подвесной модуль	<input checked="" type="checkbox"/> Tall cabinet Modulo colonna Высокий шкаф
	<input type="checkbox"/> Upper unit Modulo alto Верхний модуль	<input type="checkbox"/> Organizer Organizzatore Органайзер	<input checked="" type="checkbox"/> Shelves Mensola Полка
			<input checked="" type="checkbox"/> Accessories Accessori Аксессуары

# ciclo



The CICLO bathroom series offers us a new dimension. Its sleek design and its natural materials are created and arranged for satisfying all our senses.

Its wide range of possibilities lets us create multiple compositions, so we can achieve the ideal place for pampering our body. The noblest materials, and a perfect design and execution, are the components required for the new CICLO bathroom series.

La serie da bagno CICLO ci offre una nuova dimensione. Il design dalle linee pure e la naturalezza dei materiali sono creati e disposti per soddisfare tutti i nostri sensi.

L'ampia scelta di possibilità permette di creare molteplici composizioni per ottenere lo spazio ideale per coccolare il nostro corpo.

I materiali più nobili, design ed esecuzione perfetta sono i componenti necessari per ottenere la nuova serie da bagno CICLO.

Серия CICLO — это новый взгляд на мебель для ванных комнат. Округлые линии и природные материалы удовлетворяют самый взыскательный вкус.

Широкий диапазон возможностей этой серии позволяет создавать разнообразные комплекты. Эта мебель поможет оформить идеальную ванную комнату, где вы сможете с удовольствием расслабиться. Благородные материалы, великолепный дизайн и высококачественное исполнение — вот составляющие мебели для ванных комнат новой серии CICLO.



+info p.387

9120 Points  
CICLO blanco mate EM



+info p.388

SET 0350 3554 Points  
CICLO blanco brillo EM  
100193158





+info p.388

12658 Points  
CICLO pérغامon mate



+info p.388

3155 Points  
CICLO grafito mate

ciclo

## FINISHES

WOOD

LEGNO

ДЕРЕВО



Roble Noche

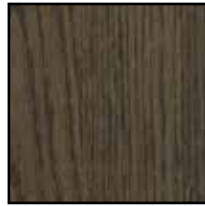

Roble Cobre



Roble Bronce



Roble Sil



Roble Alba

GLOSS LACQUER

LACCATO LUCIDO

ГЛЯНЦЕВЫЙ ЛАК



Ónix

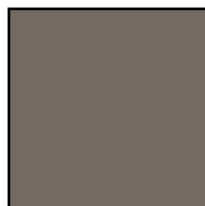

Cromo



Férreo



Tórtola



Sílice

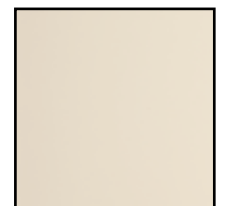

Bórax

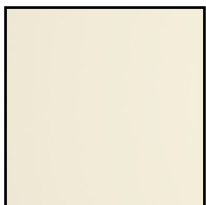

Cuarcita



Pizarra

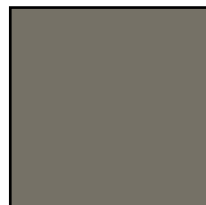

Grafito



Plomo

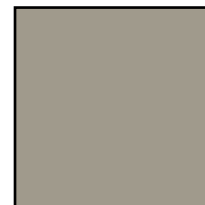

Limo

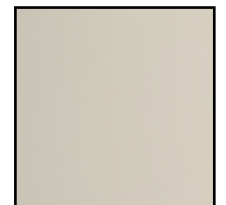

Pérgamon

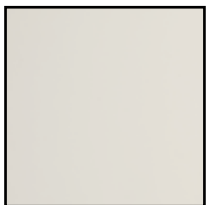

Alabastro

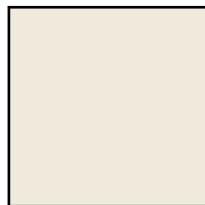

Porcelana



Negro Emotions



Ocean Blue



Azul Navy



Bottle



Orégano



Cúrcuma



Safrán



Curry

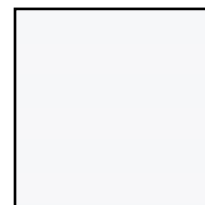

Blanco Snow

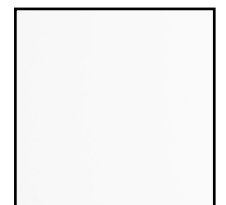

Blanco Emotions

## FINISHES

MATT LACQUER

LACCATO OPACO

МАТОВЫЙ ЛАК



Ónix



Cromo

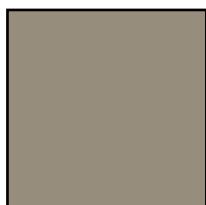

Férreo



Tórtola



Sílice



Bórax

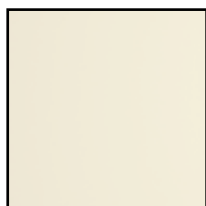

Cuarcita



Pizarra

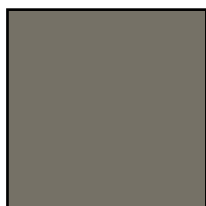

Grafito



Plomo



Limo



Pérgamon



Alabastro

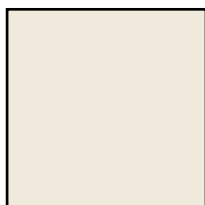

Porcelana

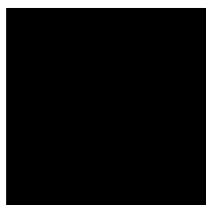

Negro Emotions



Ocean Blue



Azul Navy



Bottle



Orégano



Cúrcuma



Safrán



Curry

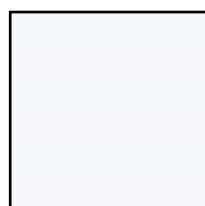

Blanco Snow

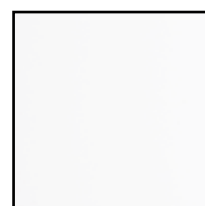

Blanco Emotions

WORKTOPS

TOP

СТОЛЕШНИЦЫ



Via Lactea



Mármol Carrara



G. Negro Tanzania M.



Granito Len



Barocco Vintage



Cheyenne Vintage



Amarula Vintage

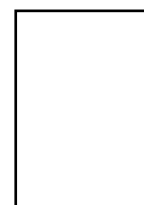

Krion

## WASH BASIN UNIT BPS-1C

DEPTH 48CM / 18<sup>7</sup>/<sub>8</sub>"

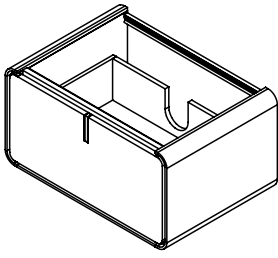

Full basin unit. Curved sides.

Base portalavabo **completa**. Fianchi curvi.

Тумбочка под умывальник полностью. Изогнутые боковые стороны.

MEASURES	()	FINISHES	WORKTOP	SAP	POINTS
70x36x48 / 27 <sup>1</sup> / <sub>2</sub> x14 <sup>1</sup> / <sub>8</sub> x18 <sup>7</sup> / <sub>8</sub>		Gloss lacquer	60	700011018	1820
		Matt lacquer	60	700011019	1597
		Wood	60	700011020	1984
100x36x48 / 39 <sup>3</sup> / <sub>8</sub> x14 <sup>1</sup> / <sub>8</sub> x18 <sup>7</sup> / <sub>8</sub>		Gloss lacquer	90	700010940	2020
		Matt lacquer	90	700010941	1751
		Wood	90	700010942	2202
130x36x48 / 51 <sup>1</sup> / <sub>8</sub> x14 <sup>1</sup> / <sub>8</sub> x18 <sup>7</sup> / <sub>8</sub>		Gloss lacquer	120	700010973	2163
		Matt lacquer	120	700010974	1910
		Wood	120	700010975	2358

## WASH BASIN UNIT BPS-2C

DEPTH 48CM / 18<sup>7</sup>/<sub>8</sub>"

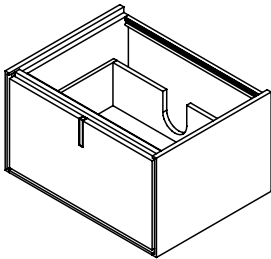

Full basin unit. Straight sides.

Base portalavabo **completa**. Fianchi retti.

Тумбочка под умывальник полностью. Прямые боковые стороны.

MEASURES	()	FINISHES	WORKTOP	SAP	POINTS
63x36x48 / 24 <sup>3</sup> / <sub>4</sub> x14 <sup>1</sup> / <sub>8</sub> x18 <sup>7</sup> / <sub>8</sub>		Gloss lacquer	60	700011060	1622
		Matt lacquer	60	700011061	1466
		Wood	60	700011062	1768
93x36x48 / 36 <sup>5</sup> / <sub>8</sub> x14 <sup>1</sup> / <sub>8</sub> x18 <sup>7</sup> / <sub>8</sub>		Gloss lacquer	90	700011033	1796
		Matt lacquer	90	700011034	1616
		Wood	90	700011035	1958
123x36x48 / 48 <sup>3</sup> / <sub>8</sub> x14 <sup>1</sup> / <sub>8</sub> x18 <sup>7</sup> / <sub>8</sub>		Gloss lacquer	120	700010955	1959
		Matt lacquer	120	700010956	1767
		Wood	120	700010957	2136

## FREESTANDING UNIT MS-1C

DEPTH 48CM / 18<sup>7</sup>/<sub>8</sub>"

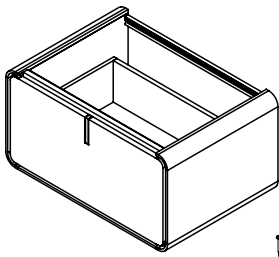

**Full** wall-hung module. Curved sides.

Modulo sospeso **completo**. Fianchi curvi.

Настенный модуль полностью. Изогнутые боковые стороны.

MEASURES	( x  x )	FINISHES	WORKTOP	SAP	POINTS
70x36x48 / 27 <sup>1</sup> / <sub>2</sub> x14 <sup>1</sup> / <sub>8</sub> x18 <sup>7</sup> / <sub>8</sub>		Gloss lacquer	60	700011021	1759
		Matt lacquer	60	700011022	1534
		Wood	60	700011023	1918
100x36x48 / 39 <sup>3</sup> / <sub>8</sub> x14 <sup>1</sup> / <sub>8</sub> x18 <sup>7</sup> / <sub>8</sub>		Gloss lacquer	90	700010943	1959
		Matt lacquer	90	700010944	1688
		Wood	90	700010945	2136
130x36x48 / 51 <sup>1</sup> / <sub>8</sub> x14 <sup>1</sup> / <sub>8</sub> x18 <sup>7</sup> / <sub>8</sub>		Gloss lacquer	120	700010976	2102
		Matt lacquer	120	700010977	1847
		Wood	120	700010978	2292

## FREESTANDING UNIT MS-2C

DEPTH 48CM / 18<sup>7</sup>/<sub>8</sub>"

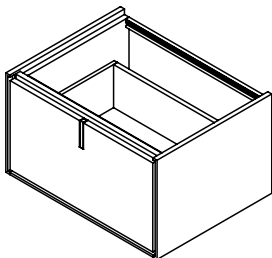

**Full** wall-hung module. Straight sides.

Modulo sospeso **completo**. Fianchi retti.

Настенный модуль полностью. Прямые боковые стороны.

MEASURES	( x  x )	FINISHES	WORKTOP	SAP	POINTS
63x36x48 / 24 <sup>3</sup> / <sub>4</sub> x14 <sup>1</sup> / <sub>8</sub> x18 <sup>7</sup> / <sub>8</sub>		Gloss lacquer	60	700011063	1575
		Matt lacquer	60	700011064	1402
		Wood	60	700011065	1717
93x36x48 / 36 <sup>5</sup> / <sub>8</sub> x14 <sup>1</sup> / <sub>8</sub> x18 <sup>7</sup> / <sub>8</sub>		Gloss lacquer	90	700011036	1751
		Matt lacquer	90	700011037	1553
		Wood	90	700011038	1909
123x36x48 / 48 <sup>3</sup> / <sub>8</sub> x14 <sup>1</sup> / <sub>8</sub> x18 <sup>7</sup> / <sub>8</sub>		Gloss lacquer	120	700010958	1934
		Matt lacquer	120	700010959	1703
		Wood	120	700010960	2109

## WASH BASIN UNIT BPS-1

DEPTH 48CM / 18<sup>7</sup>/<sub>8</sub>"

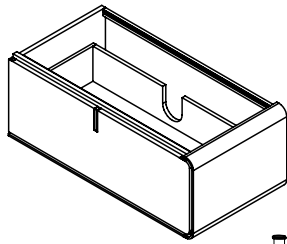

Basin unit with **NO** left side. Curved right side.

Base portalavabo **SENZA** spalla sinistro Spalla destro curvo.

Тумбочка под умывальник БЕЗ левой боковой стороны. Изогнутая правая боковая сторона.

MEASURES	( x  x )	FINISHES	SIDE	WORKTOP	SAP	POINTS
65x36x48 / 25 <sup>5</sup> / <sub>8</sub> x14 <sup>1</sup> / <sub>8</sub> x18 <sup>7</sup> / <sub>8</sub>		Gloss lacquer	DX	60	700011006	1660
		Matt lacquer	DX	60	700011007	1468
		Wood	DX	60	700011008	1810
95x36x48 / 37 <sup>3</sup> / <sub>8</sub> x14 <sup>1</sup> / <sub>8</sub> x18 <sup>7</sup> / <sub>8</sub>		Gloss lacquer	DX	90	700011039	1860
		Matt lacquer	DX	90	700011040	1623
		Wood	DX	90	700011041	2028
125x36x48 / 49 <sup>1</sup> / <sub>4</sub> x14 <sup>1</sup> / <sub>8</sub> x18 <sup>7</sup> / <sub>8</sub>		Gloss lacquer	DX	120	700010961	2004
		Matt lacquer	DX	120	700010962	1782
		Wood	DX	120	700010963	2185

## WASH BASIN UNIT BPS-1

DEPTH 48CM / 18<sup>7</sup>/<sub>8</sub>"

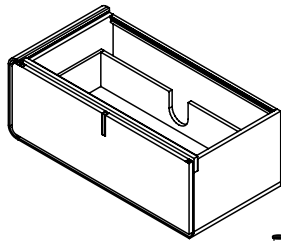

Basin unit with **NO** right side. Curved left side.

Base portalavabo **SENZA** spalla destro. Spalla sinistro curvo.

Тумбочка под умывальник БЕЗ правой боковой стороны. Изогнутая левая боковая сторона.

MEASURES	( x  x )	FINISHES	SIDE	WORKTOP	SAP	POINTS
65x36x48 / 25 <sup>5</sup> / <sub>8</sub> x14 <sup>1</sup> / <sub>8</sub> x18 <sup>7</sup> / <sub>8</sub>		Gloss lacquer	SX	60	700011009	1660
		Matt lacquer	SX	60	700011010	1468
		Wood	SX	60	700011011	1810
95x36x48 / 37 <sup>3</sup> / <sub>8</sub> x14 <sup>1</sup> / <sub>8</sub> x18 <sup>7</sup> / <sub>8</sub>		Gloss lacquer	SX	90	700011042	1860
		Matt lacquer	SX	90	700011043	1623
		Wood	SX	90	700011044	2028
125x36x48 / 49 <sup>1</sup> / <sub>4</sub> x14 <sup>1</sup> / <sub>8</sub> x18 <sup>7</sup> / <sub>8</sub>		Gloss lacquer	SX	120	700010964	2004
		Matt lacquer	SX	120	700010965	1782
		Wood	SX	120	700010966	2185

## WASH BASIN UNIT BPS-2

DEPTH 48CM / 18<sup>7</sup>/<sub>8</sub>"

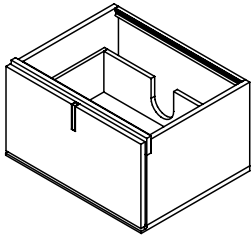

Basin unit with **NO** sides.  
Base portalavabo **SENZA** fianchi.  
Тумбочка под умывальник БЕЗ боковых сторон.



MEASURES (x x x)	FINISHES	WORKTOP	SAP	POINTS
60x36x48 / 23 <sup>5</sup> / <sub>8</sub> x14 <sup>1</sup> / <sub>8</sub> x18 <sup>7</sup> / <sub>8</sub>	Gloss lacquer	60	700011000	1491
	Matt lacquer	60	700011001	1350
	Wood	60	700011002	1626
90x36x48 / 35 <sup>3</sup> / <sub>8</sub> x14 <sup>1</sup> / <sub>8</sub> x18 <sup>7</sup> / <sub>8</sub>	Gloss lacquer	90	700011027	1678
	Matt lacquer	90	700011028	1515
	Wood	90	700011029	1830
120x36x48 / 47 <sup>1</sup> / <sub>4</sub> x14 <sup>1</sup> / <sub>8</sub> x18 <sup>7</sup> / <sub>8</sub>	Gloss lacquer	120	700010949	1841
	Matt lacquer	120	700010950	1665
	Wood	120	700010951	2007

BP

## FREESTANDING UNIT MS-1

DEPTH 48CM / 18<sup>7</sup>/<sub>8</sub>"

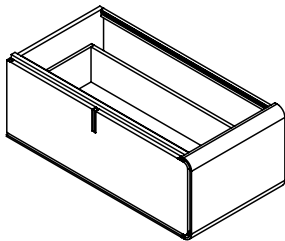

Wall-hung module with **NO** left side. Curved right side.  
Modulo sospeso **SENZA** spalla sinistro Spalla destro curvo.  
Настенный модуль БЕЗ левой боковой стороны. Изогнутая правая боковая сторона.



MEASURES (x x x)	FINISHES	SIDE	WORKTOP	SAP	POINTS
65x36x48 / 25 <sup>5</sup> / <sub>8</sub> x14 <sup>1</sup> / <sub>8</sub> x18 <sup>7</sup> / <sub>8</sub>	Gloss lacquer	DX	60	700011012	1599
	Matt lacquer	DX	60	700011013	1405
	Wood	DX	60	700011014	1743
95x36x48 / 37 <sup>3</sup> / <sub>8</sub> x14 <sup>1</sup> / <sub>8</sub> x18 <sup>7</sup> / <sub>8</sub>	Gloss lacquer	DX	90	700011045	1799
	Matt lacquer	DX	90	700011046	1560
	Wood	DX	90	700011047	1961
125x36x48 / 49 <sup>1</sup> / <sub>4</sub> x14 <sup>1</sup> / <sub>8</sub> x18 <sup>7</sup> / <sub>8</sub>	Gloss lacquer	DX	120	700010967	1961
	Matt lacquer	DX	120	700010968	1719
	Wood	DX	120	700010969	2138

## FREESTANDING UNIT MS-1

DEPTH 48CM / 18<sup>7/8</sup>"

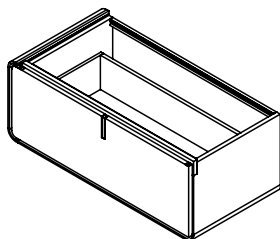

Wall-hung module with **NO** right side. Curved left side.

Modulo sospeso **SENZA** spalla destro Spalla sinistro curvo.

Настенный модуль БЕЗ правой боковой стороны. Изогнутая левая боковая сторона.

MEASURES	(xx)	FINISHES	SIDE	WORKTOP	SAP	POINTS
65x36x48 / 25 <sup>5/8</sup> x14 <sup>1/8</sup> x18 <sup>7/8</sup>		Gloss lacquer	SX	60	700011015	1599
		Matt lacquer	SX	60	700011016	1405
		Wood	SX	60	700011017	1743
95x36x48 / 37 <sup>3/8</sup> x14 <sup>1/8</sup> x18 <sup>7/8</sup>		Gloss lacquer	SX	90	700011048	1799
		Matt lacquer	SX	90	700011049	1560
		Wood	SX	90	700011050	1961
125x36x48 / 49 <sup>1/4</sup> x14 <sup>1/8</sup> x18 <sup>7/8</sup>		Gloss lacquer	SX	120	700010970	1961
		Matt lacquer	SX	120	700010971	1719
		Wood	SX	120	700010972	2138

## FREESTANDING UNIT MS-2

DEPTH 48CM / 18<sup>7/8</sup>"

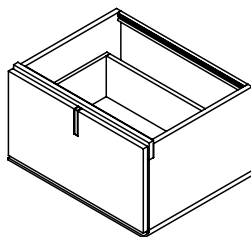

Wall-hung module with **NO** sides.

Modulo sospeso **SENZA** fianchi.

Настенный модуль БЕЗ боковых сторон.

MEASURES	(xx)	FINISHES	WORKTOP	SAP	POINTS
45x36x48 / 17 <sup>3/4</sup> x14 <sup>1/8</sup> x18 <sup>7/8</sup>		Gloss lacquer	45	700010994	1326
		Matt lacquer	45	700010995	1201
		Wood	45	700010996	1446
60x36x48 / 23 <sup>5/8</sup> x14 <sup>1/8</sup> x18 <sup>7/8</sup>		Gloss lacquer	60	700011003	1429
		Matt lacquer	60	700011004	1287
		Wood	60	700011005	1558
90x36x48 / 35 <sup>3/8</sup> x14 <sup>1/8</sup> x18 <sup>7/8</sup>		Gloss lacquer	90	700011030	1631
		Matt lacquer	90	700011031	1452
		Wood	90	700011032	1778
120x36x48 / 47 <sup>1/4</sup> x14 <sup>1/8</sup> x18 <sup>7/8</sup>		Gloss lacquer	120	700010952	1813
		Matt lacquer	120	700010953	1601
		Wood	120	700010954	1977

## OPEN SHELF

DEPTH 48CM / 18<sup>7/8</sup>"

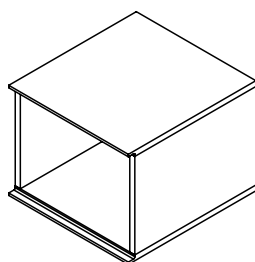

Open shelf with **NO** sides.

Cassetto sospeso **SENZA** fianchi.

Настенный ящик БЕЗ боковых сторон.

MEASURES	(xx)	FINISHES	WORKTOP	SAP	POINTS
30x36x48 / 11 <sup>3/4</sup> x14 <sup>1/8</sup> x18 <sup>7/8</sup>		Gloss lacquer	30	700010991	926
		Matt lacquer	30	700010992	798
		Wood	30	700010993	1010

MS



## SIDE COVER

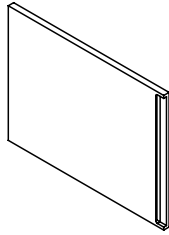

Side cover.  
Pannello laterale.  
Боковая крышка.

MEASURES	(↔x↑□x↗)	FINISHES	SAP	POINTS
1,6x36x48 / 0 <sup>5/8</sup> x14 <sup>1/8</sup> x18 <sup>7/8</sup>		Gloss lacquer	700011057	223
		Matt lacquer	700011058	184
		Wood	700011059	244

## MIRROR CICLO

DEPTH 4,5CM / 1<sup>3/4</sup>"

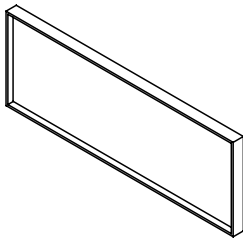

Mirror.  
Specchio  
Зеркало.

MEASURES	(↔x↑□x↗)	FINISHES	SAP	POINTS
60x36x4,5 / 23 <sup>5/8</sup> x14 <sup>1/8</sup> x1 <sup>3/4</sup>		Metal	100138790	217
90x36x4,5 / 35 <sup>3/8</sup> x14 <sup>1/8</sup> x1 <sup>3/4</sup>		Metal	100138792	260
120x36x4,5 / 47 <sup>1/4</sup> x14 <sup>1/8</sup> x1 <sup>3/4</sup>		Metal	100138774	305
150x36x4,5 / 59x14 <sup>1/8</sup> x1 <sup>3/4</sup>		Metal	100138776	356
180x36x4,5 / 70 <sup>7/8</sup> x14 <sup>1/8</sup> x1 <sup>3/4</sup>		Metal	100138778	407
60x48x4,5 / 23 <sup>5/8</sup> x18 <sup>7/8</sup> x1 <sup>3/4</sup>		Metal	100138791	241
90x48x4,5 / 35 <sup>3/8</sup> x18 <sup>7/8</sup> x1 <sup>3/4</sup>		Metal	100138793	291
120x48x4,5 / 47 <sup>1/4</sup> x18 <sup>7/8</sup> x1 <sup>3/4</sup>		Metal	100138775	344
150x48x4,5 / 59x18 <sup>7/8</sup> x1 <sup>3/4</sup>		Metal	100138777	401
180x48x4,5 / 70 <sup>7/8</sup> x18 <sup>7/8</sup> x1 <sup>3/4</sup>		Metal	100138779	458

## MIRROR CICLO

DEPTH 4,5CM / 1<sup>3/4</sup>"

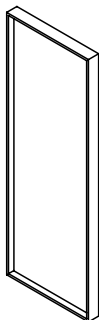

Mirror.  
Specchio  
Зеркало.



MEASURES	(↔x↑□x↗)	FINISHES	SAP	POINTS
36x60x4,5 / 14 <sup>1/8</sup> x23 <sup>5/8</sup> x1 <sup>3/4</sup>		Metal	100145431	217
36x90x4,5 / 14 <sup>1/8</sup> x35 <sup>3/8</sup> x1 <sup>3/4</sup>		Metal	100145432	260
36x120x4,5 / 14 <sup>1/8</sup> x47 <sup>1/4</sup> x1 <sup>3/4</sup>		Metal	100145408	305
36x150x4,5 / 14 <sup>1/8</sup> x59x1 <sup>3/4</sup>		Metal	100145409	356
36x180x4,5 / 14 <sup>1/8</sup> x70 <sup>7/8</sup> x1 <sup>3/4</sup>		Metal	100145430	407
48x60x4,5 / 18 <sup>7/8</sup> x23 <sup>5/8</sup> x1 <sup>3/4</sup>		Metal	100145436	241
48x90x4,5 / 18 <sup>7/8</sup> x35 <sup>3/8</sup> x1 <sup>3/4</sup>		Metal	100145437	291
48x120x4,5 / 18 <sup>7/8</sup> x47 <sup>1/4</sup> x1 <sup>3/4</sup>		Metal	100145433	344
48x150x4,5 / 18 <sup>7/8</sup> x59x1 <sup>3/4</sup>		Metal	100145434	401
48x180x4,5 / 18 <sup>7/8</sup> x70 <sup>7/8</sup> x1 <sup>3/4</sup>		Metal	100145435	458

## ROTATING SHELF

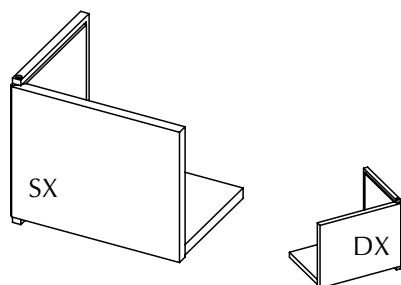
DEPTH 23CM / 9"



Rotating shelf.  
Mensola girevole.  
Вращающаяся полка.



MEASURES	(  x↑  x↑  )	FINISHES	OPENS	SAP	POINTS
30x24x23 / 11 <sup>3/4</sup> x9 <sup>1/2</sup> x9		Gloss lacquer	DX	700011051	531
		Matt lacquer	DX	700011052	452
		Wood	DX	700011053	579
		Gloss lacquer	SX	700011054	531
		Matt lacquer	SX	700011055	452
		Wood	SX	700011056	579

## ROTATING TALL CABINET WITH MIRROR

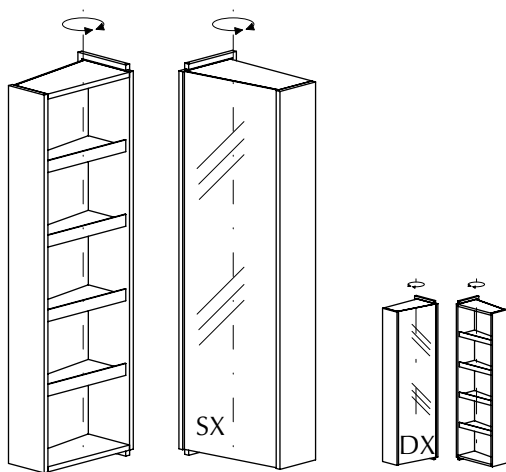
DEPTH 28CM / 11"



Rotating tall cabinet with mirror.  
Colonna girevole con specchio.  
Вращающийся высокий шкаф с зеркалом.

MEASURES	(  x↑  x↑  )	FINISHES	OPENS	SAP	POINTS
45x145x28 / 17 <sup>3/4</sup> x57 <sup>1/8</sup> x11		Gloss lacquer	DX	700013830	2192
		Matt lacquer	DX	700013831	2026
		Wood	DX	700013832	2390
		Gloss lacquer	SX	700013833	2192
		Matt lacquer	SX	700013834	2026
		Wood	SX	700013835	2390

## STONE WORKTOPS CICLO

DEPTH 500MM / 19<sup>5/8</sup>"

### FINISHES:

- G-1:  Via Lactea, Mármol Carrara.
- G-2: Granito Len, Granito Tanzania Mate.
- G-3: Barocco Vintage, Cheyenne Vintage.
- G-4: Amarula Vintage.

WORKTOPS	TOP	СТОЛЕШНИЦЫ
----------	-----	------------

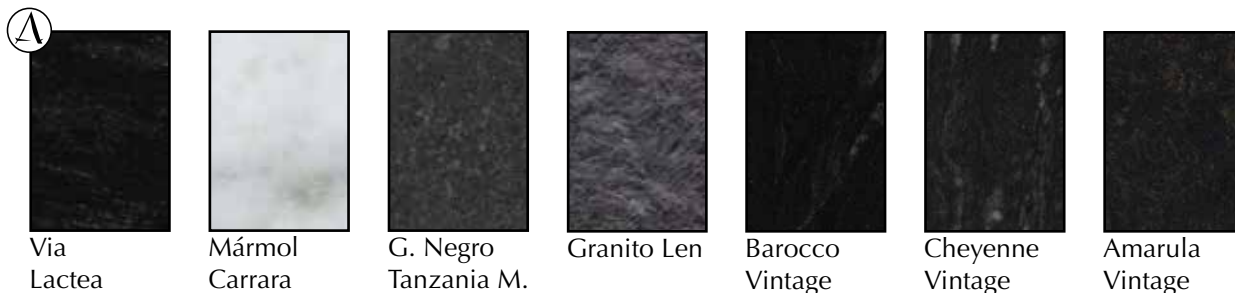

MEASURES	FINISHES	SAP	POINTS
0000-0460x20x500 / 0-18 <sup>1/8</sup> x0 <sup>3/4</sup> x19 <sup>5/8</sup>	G1	700009480	307 + *
	G2	700009481	394 + *
	G3	700009482	462 + *
	G4	700009483	539 + *
0461-0760x20x500 / 18 <sup>1/8</sup> -29 <sup>7/8</sup> x0 <sup>3/4</sup> x19 <sup>5/8</sup>	G1	700009485	406 + *
	G2	700009486	549 + *
	G3	700009487	661 + *
	G4	700009488	788 + *
0761-1060x20x500 / 30-41 <sup>3/4</sup> x0 <sup>3/4</sup> x19 <sup>5/8</sup>	G1	700009495	505 + *
	G2	700009496	705 + *
	G3	700009497	860 + *
	G4	700009498	1038 + *
1061-1360x20x500 / 41 <sup>3/4</sup> -53 <sup>1/2</sup> x0 <sup>3/4</sup> x19 <sup>5/8</sup>	G1	700009500	616 + *
	G2	700009501	873 + *
	G3	700009502	1073 + *
	G4	700009503	1301 + *
1361-1660x20x500 / 53 <sup>5/8</sup> -65 <sup>3/8</sup> x0 <sup>3/4</sup> x19 <sup>5/8</sup>	G1	700009505	715 + *
	G2	700009506	1028 + *
	G3	700009507	1272 + *
	G4	700009508	1550 + *
1661-1960x20x500 / 65 <sup>3/8</sup> -77 <sup>1/8</sup> x0 <sup>3/4</sup> x19 <sup>5/8</sup>	G1	700009510	827 + *
	G2	700009511	1197 + *
	G3	700009512	1485 + *
	G4	700009513	1813 + *

CORRESPONDING POINTS FOR MACHINED FINISHES OF STONE COUNTERTOPS  
 PUNTI CORRISPONDENTI AI DIVERSI ATTACCHI PER TOP IN STONE  
 СООТВЕТСТВУЮЩИЕ ПОЗИЦИИ ДЛЯ МАШИНОЙ ОТДЕЛКИ МРАМОРНЫХ СТОЛЕШНИЦ.

BASIN ON COUNTERTOP LAVABO SOPRATOP РАКОВИНА НА СТОЛЕШНИЦЕ	POINTS/UND.	35
*EDGE GROOVE FOR CICLO CABINET (8 mm.) *GOLA PER MOBILE CICLO (8 mm.) *УМЕНЬШЕННЫЙ КРАЙ ДЛЯ МЕБЕЛИ CICLO (8 мм).	POINTS/UND.	118

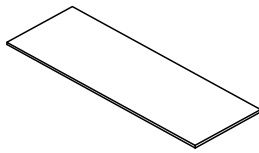

-Worktop.  
-Top.  
-СТОЛЕШНИЦА.



MEASURES	FINISHES	SAP	POINTS
0000-0460x12x500 / 0-18 <sup>1/8</sup> x0 <sup>1/2</sup> x19 <sup>5/8</sup>	KRION LUX	700009484	228 + *
0461-0760x12x500 / 18 <sup>1/8</sup> -29 <sup>7/8</sup> x0 <sup>1/2</sup> x19 <sup>5/8</sup>		700009489	334 + *
0761-1060x12x500 / 30-41 <sup>3/4</sup> x0 <sup>1/2</sup> x19 <sup>5/8</sup>		700009499	462 + *
1061-1360x12x500 / 41 <sup>3/4</sup> -53 <sup>1/2</sup> x0 <sup>1/2</sup> x19 <sup>5/8</sup>		700009504	567 + *
1361-1660x12x500 / 53 <sup>5/8</sup> -65 <sup>3/8</sup> x0 <sup>1/2</sup> x19 <sup>5/8</sup>		700009509	666 + *
1661-1960x12x500 / 65 <sup>3/8</sup> -77 <sup>1/8</sup> x0 <sup>1/2</sup> x19 <sup>5/8</sup>		700009514	776 + *
1961-2260x12x500 / 77 <sup>1/4</sup> -89x0 <sup>1/2</sup> x19 <sup>5/8</sup>		700009519	904 + *
2261-2710x12x500 / 89-106 <sup>3/4</sup> x0 <sup>1/2</sup> x19 <sup>5/8</sup>	700009524	1054 + *	

CORRESPONDING POINTS FOR MACHINED FINISHES OF KRION COUNTERTOPS  
PUNTI CORRISPONDENTI AI DIVERSI ATTACCHI PER TOP IN KRION  
СООТВЕТСТВУЮЩИЕ ПОЗИЦИИ ДЛЯ МАШИННОЙ ОТДЕЛКИ СТОЛЕШНИЦ ИЗ МАТЕРИАЛА KRION

BASIN ON COUNTERTOP LAVABO SOPRATOP РАКОВИНА НА СТОЛЕШНИЦЕ	POINTS/UND.	63
*BASIN SOTTO KRION (INCLUDED) *LAVABO SOTTO KRION (INCLUSO) *РАКОВИНА SOTTO KRION	POINTS/UND.	781
*EDGE GROOVE FOR CICLO CABINET (8 mm.) *GOLA PER MOBILE CICLO (8 mm.) *УМЕНЬШЕННЫЙ КРАЙ ДЛЯ МЕБЕЛИ CICLO (8 мм).	POINTS/UND.	35

	ALWAYS REQUIRES RICHIEDE SEMPRE ОБЯЗАТЕЛЬНО
*BASIN SOTTO KRION *LAVABO SOTTO KRION *РАКОВИНА SOTTO KRION.	VALVE VALVOLA КЛАПАН COD. 100036254
	REQUIRES MINI DRAIN RICHIEDE SCARICO MINI ТРЕБУЕТСЯ МИНИСЛИВ COD. 100036255

# LACQUER-WOOD highline

WORKTOPS CICLO

DEPTH 500MM / 19<sup>5/8</sup>"

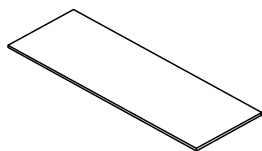

#### Features:

Lacquered or wood countertops for the CICLO bathroom series.  
For basin unit modules, we recommend stone or Krion countertops due to their greater resistance to moisture and abrasion.

#### Caratteristiche:

Top in laccato o legno per serie da bagno CICLO.  
Nei moduli base portalavabo si raccomanda di utilizzare top in stone o Krion per una maggiore resistenza all'umidità e all'abrasione.

#### Особенности:

Лакированные или деревянные столешницы для мебели серии CICLO для ванных комнат.

Для модулей с блоком раковины рекомендуем столешницы из мрамора или материала Krion. Такие столешницы отличаются повышенной стойкостью к воздействию влаги и истиранию.

MEASURES	(  )	FINISHES	SAP	POINTS	
0000-0460x19x500 / 0-18 <sup>1/8</sup> x0 <sup>3/4</sup> x19 <sup>5/8</sup>		Gloss lacquer	700011070	267	
0461-0760x19x500 / 18 <sup>1/8</sup> -29 <sup>7/8</sup> x0 <sup>3/4</sup> x19 <sup>5/8</sup>			700011076	376	
0761-1060x19x500 / 30-41 <sup>3/4</sup> x0 <sup>3/4</sup> x19 <sup>5/8</sup>			700011077	467	
1061-1360x19x500 / 41 <sup>3/4</sup> -53 <sup>1/2</sup> x0 <sup>3/4</sup> x19 <sup>5/8</sup>			700011071	577	
1361-1660x19x500 / 53 <sup>5/8</sup> -65 <sup>3/8</sup> x0 <sup>3/4</sup> x19 <sup>5/8</sup>			700011072	666	
1661-1960x19x500 / 65 <sup>3/8</sup> -77 <sup>1/8</sup> x0 <sup>3/4</sup> x19 <sup>5/8</sup>			700011073	777	
1961-2260x19x500 / 77 <sup>1/4</sup> -89x0 <sup>3/4</sup> x19 <sup>5/8</sup>			700011074	853	
2261-2710x19x500 / 89-106 <sup>3/4</sup> x0 <sup>3/4</sup> x19 <sup>5/8</sup>			700011075	967	
0000-0460x19x500 / 0-18 <sup>1/8</sup> x0 <sup>3/4</sup> x19 <sup>5/8</sup>			Matt lacquer	700011078	208
0461-0760x19x500 / 18 <sup>1/8</sup> -29 <sup>7/8</sup> x0 <sup>3/4</sup> x19 <sup>5/8</sup>				700011084	274
0761-1060x19x500 / 30-41 <sup>3/4</sup> x0 <sup>3/4</sup> x19 <sup>5/8</sup>		700011085		337	
1061-1360x19x500 / 41 <sup>3/4</sup> -53 <sup>1/2</sup> x0 <sup>3/4</sup> x19 <sup>5/8</sup>		700011079		454	
1361-1660x19x500 / 53 <sup>5/8</sup> -65 <sup>3/8</sup> x0 <sup>3/4</sup> x19 <sup>5/8</sup>		700011080		527	
1661-1960x19x500 / 65 <sup>3/8</sup> -77 <sup>1/8</sup> x0 <sup>3/4</sup> x19 <sup>5/8</sup>		700011081		592	
1961-2260x19x500 / 77 <sup>1/4</sup> -89x0 <sup>3/4</sup> x19 <sup>5/8</sup>		700011082		651	
2261-2710x19x500 / 89-106 <sup>3/4</sup> x0 <sup>3/4</sup> x19 <sup>5/8</sup>		700011083		754	
0000-0460x19x500 / 0-18 <sup>1/8</sup> x0 <sup>3/4</sup> x19 <sup>5/8</sup>		Wood		700011086	296
0461-0760x19x500 / 18 <sup>1/8</sup> -29 <sup>7/8</sup> x0 <sup>3/4</sup> x19 <sup>5/8</sup>				700011092	417
0761-1060x19x500 / 30-41 <sup>3/4</sup> x0 <sup>3/4</sup> x19 <sup>5/8</sup>			700011093	518	
1061-1360x19x500 / 41 <sup>3/4</sup> -53 <sup>1/2</sup> x0 <sup>3/4</sup> x19 <sup>5/8</sup>			700011087	640	
1361-1660x19x500 / 53 <sup>5/8</sup> -65 <sup>3/8</sup> x0 <sup>3/4</sup> x19 <sup>5/8</sup>			700011088	739	
1661-1960x19x500 / 65 <sup>3/8</sup> -77 <sup>1/8</sup> x0 <sup>3/4</sup> x19 <sup>5/8</sup>			700011089	862	
1961-2260x19x500 / 77 <sup>1/4</sup> -89x0 <sup>3/4</sup> x19 <sup>5/8</sup>			700011090	947	
2261-2710x19x500 / 89-106 <sup>3/4</sup> x0 <sup>3/4</sup> x19 <sup>5/8</sup>			700011091	1073	

#### CORRESPONDING POINTS FOR MACHINED FINISHES OF CICLO COUNTERTOPS

#### PUNTI CORRISPONDENTI AI DIVERSI ATTACCHI PER TOP CICLO

#### СООТВЕТСТВУЮЩИЕ ПОЗИЦИИ ДЛЯ МАШИННОЙ ОТДЕЛКИ СТОЛЕШНИЦ CICLO

BASIN ON COUNTERTOP  
LAVABO SOPRATOP  
РАКОВИНА НА СТОЛЕШНИЦЕ

POINTSUND.

18

## CICLO BASIN SEMI-RECESSED

DEPTH 48CM / 18<sup>7</sup>/<sub>8</sub>"

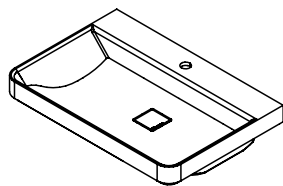

- GELCOAT basin. **REQUIRES WORKTOP.**
- It requires permanent overflow (100104178 / 59 Points).
- Lavabo GELCOAT. **RICHIEDE TOP IN.**
- Richiede valvola (100104178 / 59 punti).
- Раковина GELCOAT. **НУЖДАЕТСЯ В СТОЛЕШНИЦЕ.**
- Требуется постоянный перелив (100104178 / 59 позиций).



- Optional black plate (250055710 / 143 points).
- Copriletta nero opzionale (250055710 / 143 punti).
- Опционально черная накладка (250055710 / 143 пунктов).

MEASURES	FINISHES	SAP	POINTS
50x15x48 / 19 <sup>5</sup> / <sub>8</sub> x5 <sup>7</sup> / <sub>8</sub> x18 <sup>7</sup> / <sub>8</sub>	GELCOAT	100136309	632
70x15x48 / 27 <sup>1</sup> / <sub>2</sub> x5 <sup>7</sup> / <sub>8</sub> x18 <sup>7</sup> / <sub>8</sub>		100128501	736

## ONES BASIN SEMI-RECESSED

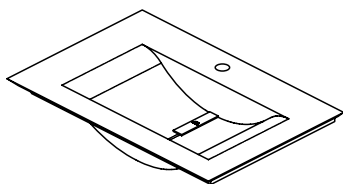

- GELCOAT basin. **REQUIRES WORKTOP.**
- Lavabo GELCOAT. **RICHIEDE TOP IN.**
- Раковина GELCOAT. **НУЖДАЕТСЯ В СТОЛЕШНИЦЕ.**



- Optional black plate (250055696 / 150 points).
- Copriletta nero opzionale (250055696 / 150 punti).
- Опционально черная накладка (250055696 / 150 пунктов).

MEASURES	FINISHES	SAP	POINTS
60x13x48 / 23 <sup>5</sup> / <sub>8</sub> x5 <sup>1</sup> / <sub>8</sub> x18 <sup>7</sup> / <sub>8</sub>	GELCOAT	100110452	0942
71,5x13x48 / 28 <sup>1</sup> / <sub>8</sub> x5 <sup>1</sup> / <sub>8</sub> x18 <sup>7</sup> / <sub>8</sub>		100100508	0982
115x13x48 / 45 <sup>1</sup> / <sub>4</sub> x5 <sup>1</sup> / <sub>8</sub> x18 <sup>7</sup> / <sub>8</sub>		100100507	1202

## SLIM BASIN

### COUNTERTOP / SOBRE ENCIMERA / VASQUE SUR PLAN

### REQUIRES WORKTOP

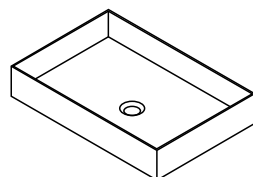

- GELCOAT basin. **REQUIRES WORKTOP.**
- Requires for installation valve SAP100036254, 68 P.
- Lavabo GELCOAT. **RICHIEDE TOP IN.**
- Richiede valvola SAP100036254, 68 P.
- Раковина GELCOAT. **НУЖДАЕТСЯ В СТОЛЕШНИЦЕ.**
- Требуется установка клапана SAP100036254, 68 P.

LA MEASURES	FINISHES	SAP	POINTS
50x10x33 / 19 <sup>5</sup> / <sub>8</sub> x3 <sup>7</sup> / <sub>8</sub> x13	GELCOAT	100221198	475

## SHELF

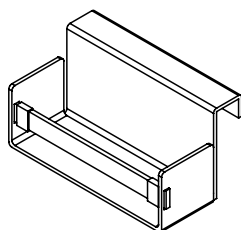

MEASURES	FINISHES	SAP	POINTS
24x13x12 / 9 <sup>1</sup> / <sub>2</sub> x5 <sup>1</sup> / <sub>8</sub> x4 <sup>3</sup> / <sub>4</sub>	Metal/Leather	100136305	181

## SHELF WITH POTS

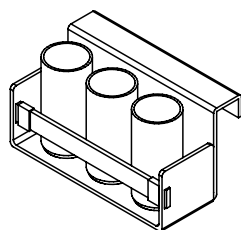

CM MEASURES	FINISHES	SAP	POINTS
24x13x12 / 9 <sup>1</sup> / <sub>2</sub> x5 <sup>1</sup> / <sub>8</sub> x4 <sup>3</sup> / <sub>4</sub>	Metal/Krion/Leather	100136306	379

## CIRCULAR TOWEL RACK

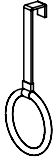

MEASURES	FINISHES	SAP	POINTS
16x36x4 / 6 <sup>1/4</sup> x14 <sup>1/8</sup> x1 <sup>5/8</sup>	Metal/Leather	100136307	117

## FLAT TOWEL RACK

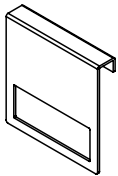

MEASURES	FINISHES	SAP	POINTS
24x24x3,6 / 9 <sup>1/2</sup> x9 <sup>1/2</sup> x1 <sup>3/8</sup>	Metal	100136308	101

## ROD

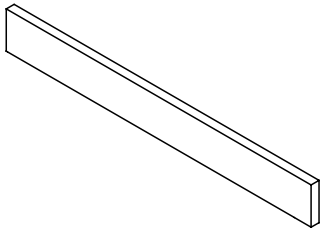

Accessory-holder rod.  
Barra portaaccessori.  
Стержень-держатель аксессуаров.

MEASURES	FINISHES	SAP	POINTS
30x12x5 / 11 <sup>3/4</sup> x4 <sup>3/4</sup> x2	Gloss lacquer	700029941	244
	Matt lacquer	700029951	204
	Wood	700029933	267
45x12x5 / 17 <sup>3/4</sup> x4 <sup>3/4</sup> x2	Gloss lacquer	700029963	266
	Matt lacquer	700029971	222
	Wood	700029934	290
60x12x5 / 23 <sup>5/8</sup> x4 <sup>3/4</sup> x2	Gloss lacquer	700010997	287
	Matt lacquer	700010998	239
	Wood	700010999	313
90x12x5 / 35 <sup>3/8</sup> x4 <sup>3/4</sup> x2	Gloss lacquer	700011024	350
	Matt lacquer	700011025	294
	Wood	700011026	382
120x12x5 / 47 <sup>1/4</sup> x4 <sup>3/4</sup> x2	Gloss lacquer	700010946	427
	Matt lacquer	700010947	351
	Wood	700010948	466
150x12x5 / 59x4 <sup>3/4</sup> x2	Gloss lacquer	700010979	479
	Matt lacquer	700010980	399
	Wood	700010981	523
180x12x5 / 70 <sup>7/8</sup> x4 <sup>3/4</sup> x2	Gloss lacquer	700010982	548
	Matt lacquer	700010983	452
	Wood	700010984	598
210x12x5 / 82 <sup>5/8</sup> x4 <sup>3/4</sup> x2	Gloss lacquer	700010985	617
	Matt lacquer	700010986	505
	Wood	700010987	673
240x12x5 / 94 <sup>1/2</sup> x4 <sup>3/4</sup> x2	Gloss lacquer	700010988	686
	Matt lacquer	700010989	558
	Wood	700010990	748



The interpretation made in inches for the dimensions of the different items shown in the price list has been rounded to 1/8, however for a more accurate measurement please use millimetres or centimetres.

In

<b>EXTERIOR FINISHES</b> FINITURE ESTERNE ОТДЕЛКА ДЛЯ НАРУЖНОГО ИСПОЛЬЗОВАНИЯ	<input type="checkbox"/> Laminate Laminato ЛАМИНАТ	<input checked="" type="checkbox"/> Matt lacquer Laccato opaco МАТОВЫЙ ЛАК	<input checked="" type="checkbox"/> Wood veneer Legno ДЕРЕВО
	<input type="checkbox"/> HPL Stratificato СЛОИСТАЯ	<input checked="" type="checkbox"/> Gloss lacquer Laccato lucido ГЛЯНЦЕВЫЙ ЛАК	
<b>INTERIOR FINISHES</b> FINITURE INTERNE ОТДЕЛКА ДЛЯ ВНУТРЕННЕГО ИСПОЛЬЗОВАНИЯ	<input type="checkbox"/> Laminate Laminato ЛАМИНАТ	<input checked="" type="checkbox"/> Wood veneer Legno ДЕРЕВО	<input type="checkbox"/> Aluminium+laminated base Alluminio + base in laminato Алюминий + основа из ламината
	<input type="checkbox"/> Front handle Maniglia frontale a vista Декоративная передняя ручка	<input type="checkbox"/> Integrated metal handle Maniglia metallica integrata Встроенная металлическая ручка	<input checked="" type="checkbox"/> Integrated mechanized h. Maniglia integrata ricavata sul bordo Встроенная ручка по краю
<b>HANDLES</b> MANIGLIE РУЧКИ	<input type="checkbox"/> Push handle Maniglia Push РУЧКИ Push		
<b>TYPE OF UNITS</b> TIPI DI MODULI ТИПЫ МОДУЛЕЙ	<input checked="" type="checkbox"/> Compact Compatto Компактная	<input checked="" type="checkbox"/> Modular Modulare Модульная	
<b>POSITION</b> POSIZIONE ПОЗИЦИЯ	<input checked="" type="checkbox"/> Wall-mounted Sospeso Подвесная	<input type="checkbox"/> Floor-mounted A terra Напольная	
<b>MEASURES (CM)</b> DIMENSIONI РАЗМЕРЫ	<input checked="" type="checkbox"/> 60 / 90 / 120 23 <sup>5/8</sup> / 35 <sup>3/8</sup> / 47 <sup>1/4</sup>	<input checked="" type="checkbox"/> 24 / 48 9 <sup>1/2</sup> / 18 <sup>7/8</sup>	<input checked="" type="checkbox"/> 48 18 <sup>7/8</sup>
<b>WORKTOP &amp; BASIN OPTIONS</b> OPZIONI TOP E LAVABI ВАРИАНТЫ СТОЛЕШНИЦ И УМЫВАЛЬНЫХ РАКОВИН	<input checked="" type="checkbox"/> Bath serie's worktop / basin Lavabo / top della serie Серийная умывальная раковина / столешница	<input type="checkbox"/> Standard worktops Top standard Стандартные столешницы	<input type="checkbox"/> Worktop + integrated basin Encimera + lavabo integrato Столешница + встроенная умывальная раковина
	<input checked="" type="checkbox"/> Over-mounted basin Lavabo da appoggio Настольная умывальная раковина	<input type="checkbox"/> Under-mounted basin Lavabo sottopiano Умывальная раковина, встраиваемая в столешницу снизу	<input type="checkbox"/> Double basin as option Opzione doppia vasca Вариант с двойной чашей
<b>WORKTOP FINISHES</b> FINITURE TOP ОТДЕЛКА СТОЛЕШНИЦ	<input type="checkbox"/> Krion® worktop Top in KRION® Столешница KRION®	<input type="checkbox"/> Gel Coat worktop Top in Gel Coat Столешница с покрытием гелькоут	<input type="checkbox"/> Natural Stone worktop Top in pietra naturale Столешница из натурального камня.
	<input type="checkbox"/> Glass worktop Top in vetro Столешница из стекла	<input checked="" type="checkbox"/> Bath furniture finish worktop Top con la finitura del mobile Столешница с той же отделкой, что и консоль/тумба	
<b>BASIN FINISHES</b> FINITURE LAVABI ОТДЕЛКА УМЫВАЛЬНЫХ РАКОВИН	<input type="checkbox"/> Krion® basin Lavabo in Krion® Умывальная раковина из Krion®	<input checked="" type="checkbox"/> Gel Coat basin Lavabo Gelcoat Раковина Gelcoat	<input type="checkbox"/> Ceramic basin Lavabo in ceramica Керамическая умывальная раковина
	<input type="checkbox"/> Natural Stone basin Lavabo in pietra naturale Умывальная раковина из натурального камня.		
<b>ACCESSORIES</b> ACCESSORI АКСЕССУАРЫ	<input checked="" type="checkbox"/> Mirror Specchio Зеркало	<input checked="" type="checkbox"/> Wall-mounted module Modulo sospeso Подвесной модуль	<input checked="" type="checkbox"/> Tall cabinet Modulo colonna Высокий шкаф
	<input checked="" type="checkbox"/> Upper unit Modulo alto Верхний модуль	<input checked="" type="checkbox"/> Organizer Organizzatore Органайзер	<input type="checkbox"/> Shelves Mensola Полка
			<input type="checkbox"/> Accessories Accessori Аксессуары



## *in*



Unit with mitre-edged panels and fronts, with the mitre cut into the edges acting as a handle and giving it a unique, distinctive design. The series features washbasin units, high units, low units, shelves and mirrors with LED lighting featuring a touch button system. Draw organisation system available, oak veneer containers.

Mobile composto con pannelli e frontali con angoli a smusso. Lo smusso negli angoli serve come maniglia e caratterizza il disegno del mobile. La serie è composta da basi portalavabo, moduli pensili, moduli base, mensole e specchi con illuminazione a led con pulsante touch. Organizer interno ai cassetti formato da contenitori in rovere

Блок со срезанными кромками панелей и торцов. Косой срез кромки служит ручкой и придает всей конструкции оригинальный вид. В серию входят блоки умывальной раковины, высокие блоки, низкие блоки, полки и зеркала со светодиодной подсветкой и системой сенсорной кнопки. Возможна интеграция системы выдвижных ящиков и контейнеров из дубового шпона.



+info p.388

12483 Points  
IN Roble Noche



**FINISHES****WOOD****LEGNO****ДЕРЕВО**

Roble Noche



Roble Cobre



Roble Bronce



Roble Sil



Roble Alba

**GLOSS LACQUER****LACCATO LUCIDO****ГЛЯНЦЕВЫЙ ЛАК**

Ónix

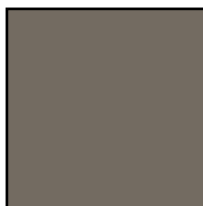

Cromo



Férreo



Tórtola



Sílice

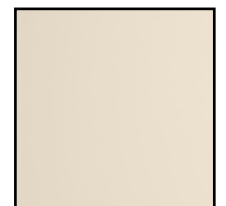

Bórax

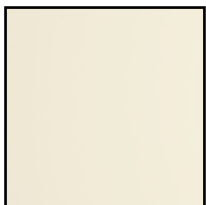

Cuarcita



Pizarra

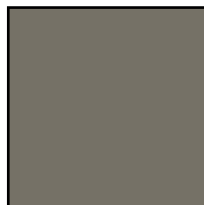

Grafito



Plomo

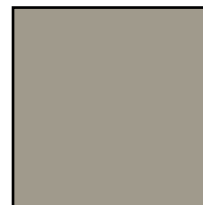

Limo

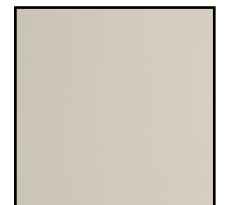

Pérgamon

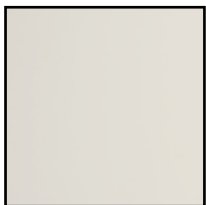

Alabastro



Porcelana



Negro Emotions



Ocean Blue



Azul Navy



Bottle

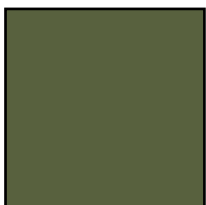

Orégano



Cúrcuma



Safrán



Curry

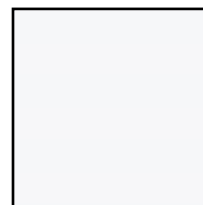

Blanco Snow

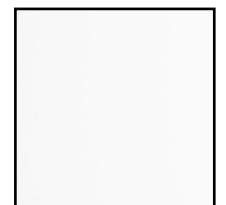

Blanco Emotions

## FINISHES

MATT LACQUER

LACCATO OPACO

МАТОВЫЙ ЛАК



Ónix

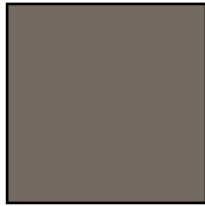

Cromo

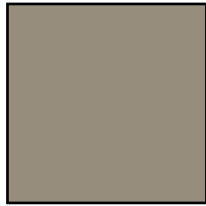

Férreo



Tórtola



Sílice

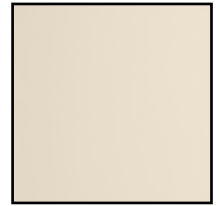

Bórax

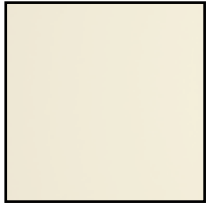

Cuarcita



Pizarra

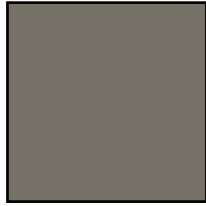

Grafito



Plomo



Limo

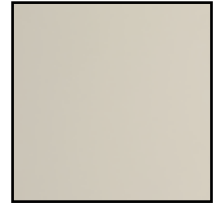

Pérgamon

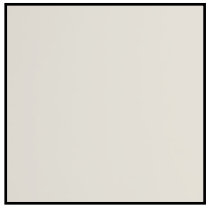

Alabastro

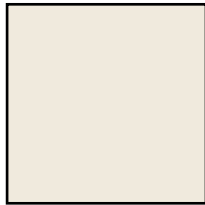

Porcelana



Negro Emotions



Ocean Blue



Azul Navy

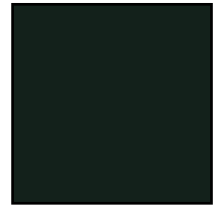

Bottle



Orégano



Cúrcuma



Safrán



Curry



Blanco Snow

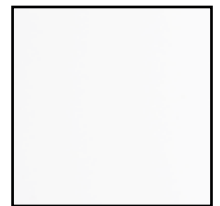

Blanco Emotions

## WASH BASIN UNIT BPS-1

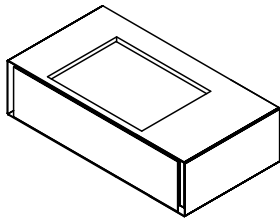
DEPTH 48CM / 18<sup>7</sup>/<sub>8</sub>"

Wash basin unit. Chrome waste is recommended (100100505).

Basi portalavabo Si raccomanda scarico cromato (100100505).

Тумбочка под умывальник. Рекомендуется использовать хромированный донный клапан (100100505).

**Basin options:**

**BPS-1 60 cm.:** Lavabo "ONES 60", "CICLO 50", "SLIM 50".

**BPS-1 90 cm.:** Lavabo "ONES 60/71,5", "CICLO 50/70", "SLIM 50".

**BPS-1 120 cm.:** Lavabo "ONES 60/71,5", "CICLO 50/70", "ONES 115" centered, "SLIM 50".

MEASURES	(  )	FINISHES	BASIN	SAP	POINTS
60x24x48 / 23 <sup>5</sup> / <sub>8</sub> x9 <sup>1</sup> / <sub>2</sub> x18 <sup>7</sup> / <sub>8</sub>		Gloss lacquer	CENTERED	700007236	1579
		Matt lacquer	CENTERED	700007233	1338
		Wood	CENTERED	700007230	1793
90x24x48 / 35 <sup>3</sup> / <sub>8</sub> x9 <sup>1</sup> / <sub>2</sub> x18 <sup>7</sup> / <sub>8</sub>		Gloss lacquer	CENTERED	700007237	1846
		Matt lacquer	CENTERED	700007234	1536
		Wood	CENTERED	700007231	2069
120x24x48 / 47 <sup>1</sup> / <sub>4</sub> x9 <sup>1</sup> / <sub>2</sub> x18 <sup>7</sup> / <sub>8</sub>		Gloss lacquer	SX	700007238	2157
		Matt lacquer	SX	700007235	1766
		Wood	SX	700007232	2327

## WASH BASIN UNIT BPS-1 H

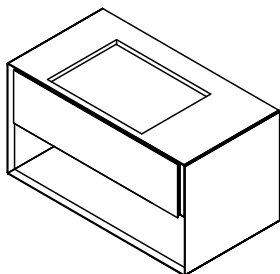
DEPTH 48CM / 18<sup>7</sup>/<sub>8</sub>"

Wash basin unit. Chrome waste is recommended (100100505).

Basi portalavabo Si raccomanda scarico cromato (100100505).

Тумбочка под умывальник. Рекомендуется использовать хромированный донный клапан (100100505).

**Basin options:**

**BPS-1 H 60 cm.:** Lavabo "ONES 60", "CICLO 50", "SLIM 50".

**BPS-1 H 90 cm.:** Lavabo "ONES 60/71,5", "CICLO 50/70", "SLIM 50".

**BPS-1 H 120 cm.:** Lavabo "ONES 60/71,5", "CICLO 50/70", "ONES 115" centered, "SLIM 50".

MEASURES	(  )	FINISHES	BASIN	SAP	POINTS
60x48x48 / 23 <sup>5</sup> / <sub>8</sub> x18 <sup>7</sup> / <sub>8</sub> x18 <sup>7</sup> / <sub>8</sub>		Gloss lacquer	CENTERED	700007245	2069
		Matt lacquer	CENTERED	700007242	1694
		Wood	CENTERED	700007239	2401
90x48x48 / 35 <sup>3</sup> / <sub>8</sub> x18 <sup>7</sup> / <sub>8</sub> x18 <sup>7</sup> / <sub>8</sub>		Gloss lacquer	CENTERED	700007246	2426
		Matt lacquer	CENTERED	700007243	1953
		Wood	CENTERED	700007240	2800
120x48x48 / 47 <sup>1</sup> / <sub>4</sub> x18 <sup>7</sup> / <sub>8</sub> x18 <sup>7</sup> / <sub>8</sub>		Gloss lacquer	SX	700007247	2837
		Matt lacquer	SX	700007244	2249
		Wood	SX	700007241	3169

## WASH BASIN UNIT BPS-2

DEPTH 48CM / 18<sup>7/8</sup>"

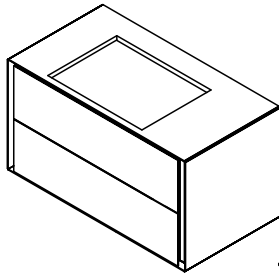

Wash basin unit. Chrome waste is recommended (100100505).

Basi portalavabo Si raccomanda scarico cromato (100100505).

Тумбочка под умывальник. Рекомендуется использовать хромированный донный клапан (100100505).

**Basin options:**

**BPS-2 60 cm.:** Lavabo "ONES 60", "CICLO 50", "SLIM 50".

**BPS-2 90 cm.:** Lavabo "ONES 60/71,5", "CICLO 50/70", "SLIM 50".

**BPS-2 120 cm.:** Lavabo "ONES 60/71,5", "CICLO 50/70", "ONES 115" centered, "SLIM 50".

MEASURES	( x  x )	FINISHES	BASIN	SAP	POINTS
60x48x48 / 23 <sup>5/8</sup> x18 <sup>7/8</sup> x18 <sup>7/8</sup>		Gloss lacquer	CENTERED	700007254	2244
		Matt lacquer	CENTERED	700007251	1927
		Wood	CENTERED	700007248	2450
90x48x48 / 35 <sup>3/8</sup> x18 <sup>7/8</sup> x18 <sup>7/8</sup>		Gloss lacquer	CENTERED	700007255	2608
		Matt lacquer	CENTERED	700007252	2206
		Wood	CENTERED	700007249	2811
120x48x48 / 47 <sup>1/4</sup> x18 <sup>7/8</sup> x18 <sup>7/8</sup>		Gloss lacquer	SX	700007256	3015
		Matt lacquer	SX	700007253	2516
		Wood	SX	700007250	3152

## WASH BASIN UNIT BPS-3

DEPTH 48CM / 18<sup>7/8</sup>"

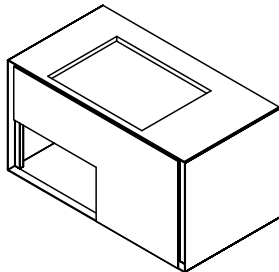

Wash basin unit. Chrome waste is recommended (100100505).

Basi portalavabo Si raccomanda scarico cromato (100100505).

Тумбочка под умывальник. Рекомендуется использовать хромированный донный клапан (100100505).

**Basin options:**

**BPS-3 90 cm.:** Lavabo "ONES 60/71,5", "CICLO 50/70", "SLIM 50".

**BPS-3 120 cm.:** Lavabo "ONES 60/71,5/115", "CICLO 50/70", "SLIM 50".

MEASURES	( x  x )	FINISHES	BASIN	GAP	SAP	POINTS
90x48x48 / 35 <sup>3/8</sup> x18 <sup>7/8</sup> x18 <sup>7/8</sup>		Gloss lacquer	CENTERED	SX	700007261	2642
		Matt lacquer	CENTERED	SX	700007259	2142
		Wood	CENTERED	SX	700007257	3085
		Gloss lacquer	CENTERED	DX	700007267	2641
		Matt lacquer	CENTERED	DX	700007265	2141
		Wood	CENTERED	DX	700007263	3084
120x48x48 / 47 <sup>1/4</sup> x18 <sup>7/8</sup> x18 <sup>7/8</sup>		Gloss lacquer	CENTERED	SX	700007262	3024
		Matt lacquer	CENTERED	SX	700007260	2428
		Wood	CENTERED	SX	700007258	3411
		Gloss lacquer	CENTERED	DX	700007268	3023
		Matt lacquer	CENTERED	DX	700007266	2427
		Wood	CENTERED	DX	700007264	3429

## FREESTANDING UNIT MS-1

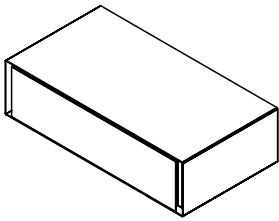
DEPTH 48CM / 18<sup>7</sup>/<sub>8</sub>"

Wallmounted unit.

Modulo sospeso

Блок настенного монтажа.

MEASURES	FINISHES	SAP	POINTS
60x24x48 / 23 <sup>5</sup> / <sub>8</sub> x9 <sup>1</sup> / <sub>2</sub> x18 <sup>7</sup> / <sub>8</sub>	Gloss lacquer	700007275	1556
	Matt lacquer	700007272	1314
	Wood	700007269	1777
90x24x48 / 35 <sup>3</sup> / <sub>8</sub> x9 <sup>1</sup> / <sub>2</sub> x18 <sup>7</sup> / <sub>8</sub>	Gloss lacquer	700007276	1831
	Matt lacquer	700007273	1520
	Wood	700007270	2061
120x24x48 / 47 <sup>1</sup> / <sub>4</sub> x9 <sup>1</sup> / <sub>2</sub> x18 <sup>7</sup> / <sub>8</sub>	Gloss lacquer	700007277	2153
	Matt lacquer	700007274	1762
	Wood	700007271	2332

## FREESTANDING UNIT MS-1 H

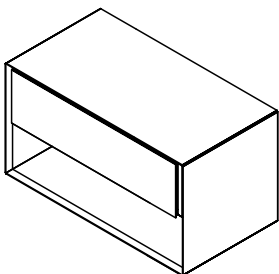
DEPTH 48CM / 18<sup>7</sup>/<sub>8</sub>"

Wallmounted unit.

Modulo sospeso

Блок настенного монтажа.

MEASURES	FINISHES	SAP	POINTS
60x48x48 / 23 <sup>5</sup> / <sub>8</sub> x18 <sup>7</sup> / <sub>8</sub> x18 <sup>7</sup> / <sub>8</sub>	Gloss lacquer	700007284	2072
	Matt lacquer	700007281	1678
	Wood	700007278	2381
90x48x48 / 35 <sup>3</sup> / <sub>8</sub> x18 <sup>7</sup> / <sub>8</sub> x18 <sup>7</sup> / <sub>8</sub>	Gloss lacquer	700007285	2442
	Matt lacquer	700007282	1947
	Wood	700007279	2810
120x48x48 / 47 <sup>1</sup> / <sub>4</sub> x18 <sup>7</sup> / <sub>8</sub> x18 <sup>7</sup> / <sub>8</sub>	Gloss lacquer	700007286	2873
	Matt lacquer	700007283	2257
	Wood	700007280	3268



## FREESTANDING UNIT MS-2

DEPTH 48CM / 18<sup>7/8</sup>"

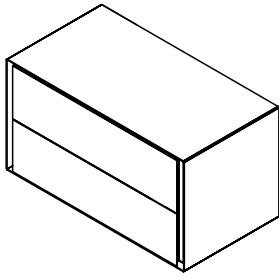

Wallmounted unit.  
Modulo sospeso  
Блок настенного монтажа.

MEASURES	(  )	FINISHES	SAP	POINTS
60x48x48 / 23 <sup>5/8</sup> x18 <sup>7/8</sup> x18 <sup>7/8</sup>		Gloss lacquer	700007293	2194
		Matt lacquer	700007290	1875
		Wood	700007287	2409
90x48x48 / 35 <sup>3/8</sup> x18 <sup>7/8</sup> x18 <sup>7/8</sup>		Gloss lacquer	700007294	2566
		Matt lacquer	700007291	2163
		Wood	700007288	2779
120x48x48 / 47 <sup>1/4</sup> x18 <sup>7/8</sup> x18 <sup>7/8</sup>		Gloss lacquer	700007295	2985
		Matt lacquer	700007292	2484
		Wood	700007289	3131

## FREESTANDING UNIT MS-3

DEPTH 48CM / 18<sup>7/8</sup>"

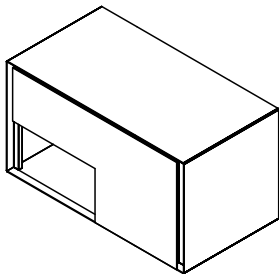

Wallmounted unit.  
Modulo sospeso  
Блок настенного монтажа.

MEASURES	(  )	FINISHES	GAP	SAP	POINTS
90x48x48 / 35 <sup>3/8</sup> x18 <sup>7/8</sup> x18 <sup>7/8</sup>		Gloss lacquer	SX	700007300	2686
		Matt lacquer	SX	700007298	2155
		Wood	SX	700007296	3094
		Gloss lacquer	DX	700007306	2684
		Matt lacquer	DX	700007304	2154
		Wood	DX	700007302	3093
120x48x48 / 47 <sup>1/4</sup> x18 <sup>7/8</sup> x18 <sup>7/8</sup>		Gloss lacquer	SX	700007301	3116
		Matt lacquer	SX	700007299	2463
		Wood	SX	700007297	3519
		Gloss lacquer	DX	700007307	3116
		Matt lacquer	DX	700007305	2463
		Wood	DX	700007303	3539

## TALL CABINET MA

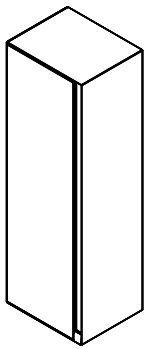
DEPTH 20CM / 7<sup>7</sup>/<sub>8</sub>"

Tall cabinet.  
Colonna.  
Высокий шкаф.

MEASURES	(  )	FINISHES	OPENS	SAP	POINTS
30x60x20 / 11 <sup>3</sup> / <sub>4</sub> x23 <sup>5</sup> / <sub>8</sub> x7 <sup>7</sup> / <sub>8</sub>		Gloss lacquer	SX	700007353	1145
		Matt lacquer	SX	700007349	0948
		Wood	SX	700007345	1386
		Gloss lacquer	DX	700007341	1142
		Matt lacquer	DX	700007337	0945
		Wood	DX	700007333	1385
30x90x20 / 11 <sup>3</sup> / <sub>4</sub> x35 <sup>3</sup> / <sub>8</sub> x7 <sup>7</sup> / <sub>8</sub>		Gloss lacquer	SX	700007354	1400
		Matt lacquer	SX	700007350	1137
		Wood	SX	700007346	1625
		Gloss lacquer	DX	700007342	1400
		Matt lacquer	DX	700007338	1137
		Wood	DX	700007334	1625

## TALL CABINET MA-H

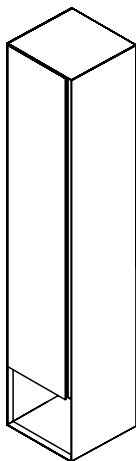
DEPTH 30CM / 11<sup>3</sup>/<sub>4</sub>"

Tall cabinet.  
Colonna.  
Высокий шкаф.

MEASURES	(  )	FINISHES	OPENS	SAP	POINTS
30x156x30 / 11 <sup>3</sup> / <sub>4</sub> x61 <sup>3</sup> / <sub>8</sub> x11 <sup>3</sup> / <sub>4</sub>		Gloss lacquer	DX	700013836	2235
		Matt lacquer	DX	700013837	1821
		Wood	DX	700013838	2547
30x156x30 / 11 <sup>3</sup> / <sub>4</sub> x61 <sup>3</sup> / <sub>8</sub> x11 <sup>3</sup> / <sub>4</sub>		Gloss lacquer	SX	700013839	2235
		Matt lacquer	SX	700013821	1821
		Wood	SX	700013822	2547

## FREESTANDING UNIT MA

DEPTH 20CM / 7<sup>7</sup>/<sub>8</sub>"

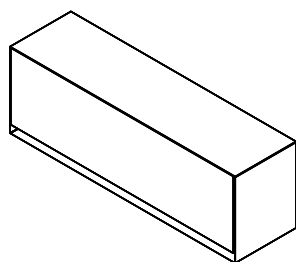

Upper unit.  
Modulo pensile.  
Верхний блок.

MEASURES	()	FINISHES	SAP	POINTS
60x30x20 / 23 <sup>5</sup> / <sub>8</sub> x11 <sup>3</sup> / <sub>4</sub> x7 <sup>7</sup> / <sub>8</sub>		Gloss lacquer	700007365	1185
		Matt lacquer	700007361	0989
		Wood	700007357	1431
90x30x20 / 35 <sup>3</sup> / <sub>8</sub> x11 <sup>3</sup> / <sub>4</sub> x7 <sup>7</sup> / <sub>8</sub>		Gloss lacquer	700007366	1426
		Matt lacquer	700007362	1165
		Wood	700007358	1649

MA

## MIRROR

DEPTH 3CM / 1<sup>1</sup>/<sub>8</sub>"



Mirror.  
Specchio con illuminazione.  
Зеркало с подсветкой.

MEASURES	()	FINISHES	SAP	POINTS
30x120x3 / 11 <sup>3</sup> / <sub>4</sub> x47 <sup>1</sup> / <sub>4</sub> x1 <sup>1</sup> / <sub>8</sub>		Gloss lacquer	700007379	0350
		Matt lacquer	700007380	0297
		Wood	700007381	0359

MIRROR

DEPTH 17CM / 6<sup>3</sup>/<sub>4</sub>"

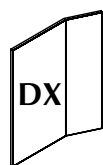
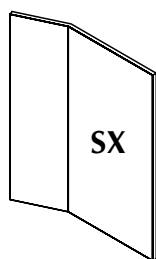

Mirror.  
Specchio  
Зеркало.

MEASURES	(xx)	FINISHES	MIRROR	SAP	POINTS
70x96x17 / 27 <sup>1</sup> / <sub>2</sub> x37 <sup>3</sup> / <sub>4</sub> x6 <sup>3</sup> / <sub>4</sub>		Gloss lacquer	SX	700007403	1275
		Matt lacquer	SX	700007404	1192
		Wood	SX	700007405	1419
70x96x17 / 27 <sup>1</sup> / <sub>2</sub> x37 <sup>3</sup> / <sub>4</sub> x6 <sup>3</sup> / <sub>4</sub>		Gloss lacquer	DX	700007400	1275
		Matt lacquer	DX	700007401	1192
		Wood	DX	700007402	1419

MIRROR

DEPTH 18CM / 7<sup>1</sup>/<sub>8</sub>"

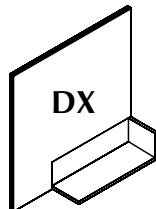
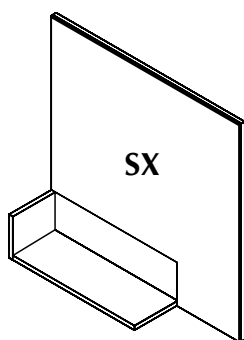

Mirror.  
Specchio  
Зеркало.

MEASURES	(xx)	SHELF	MIRROR	SAP	POINTS
60x90x18 / 23 <sup>5</sup> / <sub>8</sub> x35 <sup>3</sup> / <sub>8</sub> x7 <sup>1</sup> / <sub>8</sub>		Gloss lacquer	SX	700007397	0784
		Matt lacquer	SX	700007398	0681
		Wood	SX	700007399	0912
		Gloss lacquer	DX	700007394	0784
		Matt lacquer	DX	700007395	0681
		Wood	DX	700007396	0912
90x90x18 / 35 <sup>3</sup> / <sub>8</sub> x35 <sup>3</sup> / <sub>8</sub> x7 <sup>1</sup> / <sub>8</sub>		Gloss lacquer	SX	700007385	0974
		Matt lacquer	SX	700007386	0813
		Wood	SX	700007387	1088
		Gloss lacquer	DX	700007382	0974
		Matt lacquer	DX	700007383	0813
		Wood	DX	700007384	1088
120x90x18 / 47 <sup>1</sup> / <sub>4</sub> x35 <sup>3</sup> / <sub>8</sub> x7 <sup>1</sup> / <sub>8</sub>		Gloss lacquer	SX	700007391	1141
		Matt lacquer	SX	700007392	0943
		Wood	SX	700007393	1262
		Gloss lacquer	DX	700007388	1140
		Matt lacquer	DX	700007389	0941
		Wood	DX	700007390	1260

## ONES BASIN SEMI-RECESSED

DEPTH 48CM / 18<sup>7/8</sup>"

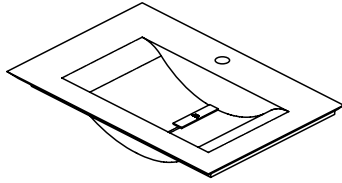

- GELCOAT basin.
- Lavabo KRION.
- Раковина KRION.



- Optional black plate (250055696 / 150 points).
- Copripiletta nero opzionale (250055696 / 150 punti).
- Опционально черная накладка (250055696 / 150 пунктов).

MEASURES	FINISHES	SAP	POINTS
60x13x48 / 23 <sup>5/8</sup> x5 <sup>1/8</sup> x18 <sup>7/8</sup>	GELCOAT	100110452	0942
71,5x13x48 / 28 <sup>1/8</sup> x5 <sup>1/8</sup> x18 <sup>7/8</sup>		100100508	0982

## ONES BASIN SEMI-RECESSED

DEPTH 48CM / 18<sup>7/8</sup>"

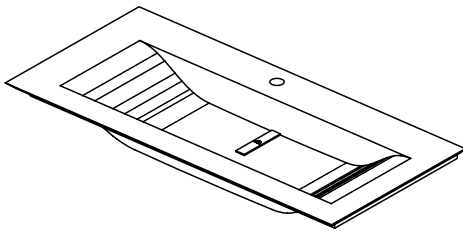

- GELCOAT basin.
- Lavabo GELCOAT.
- Раковина GELCOAT.



- Optional black plate (250055696 / 150 points).
- Copripiletta nero opzionale (250055696 / 150 punti).
- Опционально черная накладка (250055696 / 150 пунктов).

MEASURES	FINISHES	SAP	POINTS
115x13x48 / 45 <sup>1/4</sup> x5 <sup>1/8</sup> x18 <sup>7/8</sup>	GELCOAT	100100507	1202

## CICLO BASIN SEMI-RECESSED

DEPTH 48CM / 18<sup>7/8</sup>"

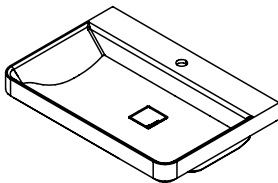

- GELCOAT basin.
- It requires permanent overflow (100104178 / 59 Points).
- Lavabo GELCOAT.
- Richiede valvola (100104178 / 59 punti).
- Раковина GELCOAT.
- Требуется постоянный перелив (100104178 / 59 позиций).



- Optional black plate (250055710 / 143 points).
- Copripiletta nero opzionale (250055710 / 143 punti).
- Опционально черная накладка (250055710 / 143 пунктов).

MEASURES	FINISHES	SAP	POINTS
50x15x48 / 19 <sup>5/8</sup> x5 <sup>7/8</sup> x18 <sup>7/8</sup>	GELCOAT	100136309	632
70x15x48 / 27 <sup>1/2</sup> x5 <sup>7/8</sup> x18 <sup>7/8</sup>		100128501	736

## SLIM BASIN

COUNTERTOP / SOBRE ENCIMERA / VASQUE SUR PLAN

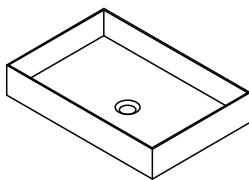

- GELCOAT basin.
- Requires for installation valve SAP100036254, 68 P.
- Lavabo GELCOAT.
- Richiede valvola SAP100036254, 68 P.
- Раковина GELCOAT.
- Требуется установка клапана SAP100036254, 68 P.

MEASURES	FINISHES	SAP	POINTS
50x10x33 / 19 <sup>5/8</sup> x3 <sup>7/8</sup> x13	GELCOAT	100221198	475

## DRAINAGE CHROME



- Drainage chrome.
- Scarico cromato.
- Дренаж хромированный.

FINISHES	SAP	POINTS
Cromado	100100505	0281

**DRAWER ORGANISATION SYSTEM**

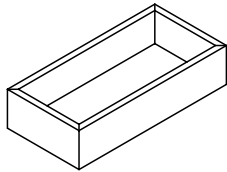

Drawer organisation system.  
 Organizer interno dei cassetti.  
 Система хранения с выдвижными ящиками.

MEASURES		BODY FINISHES	SAP	POINTS
17x8x17 / 6 <sup>3/4</sup> x3 <sup>1/8</sup> x6 <sup>3/4</sup> (A)		Wood	100100502	0043
17x8x35 / 6 <sup>3/4</sup> x3 <sup>1/8</sup> x13 <sup>3/4</sup> (B)			100100501	0055

**ORGANISATION OPTIONS**

Drawer 120 cm.  
 Cassetto 120 cm.  
 Выдвижной ящик 120 см.

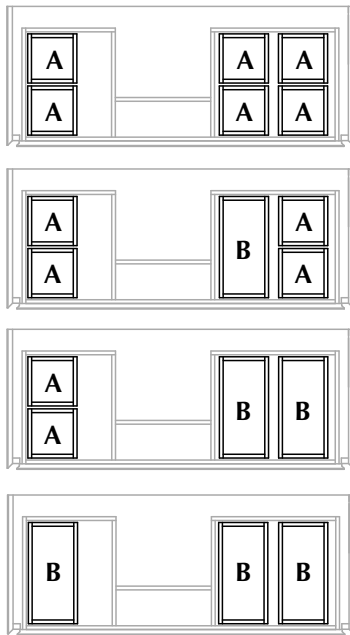

Drawer 90 cm.  
 Cassetto 90 cm.  
 Выдвижной ящик 90 см.

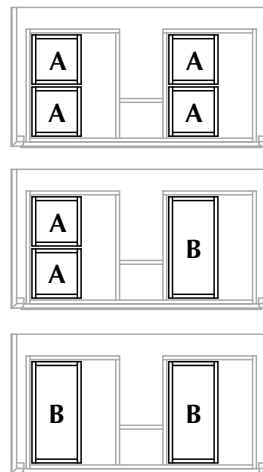

# highline

**FINISHES:**

**G-1:** Ⓐ Arctic White, Ⓐ Via Lactea, Mármol Carrara, Mármol Blanco Ibiza.

**G-2:** Granito Len, Granito Tanzania Mate.

**G-3:** Barocco Vintage, Cheyenne Vintage, Arabescato Orobico.

**G-4:** Amarula Vintage, Granito Portobello.

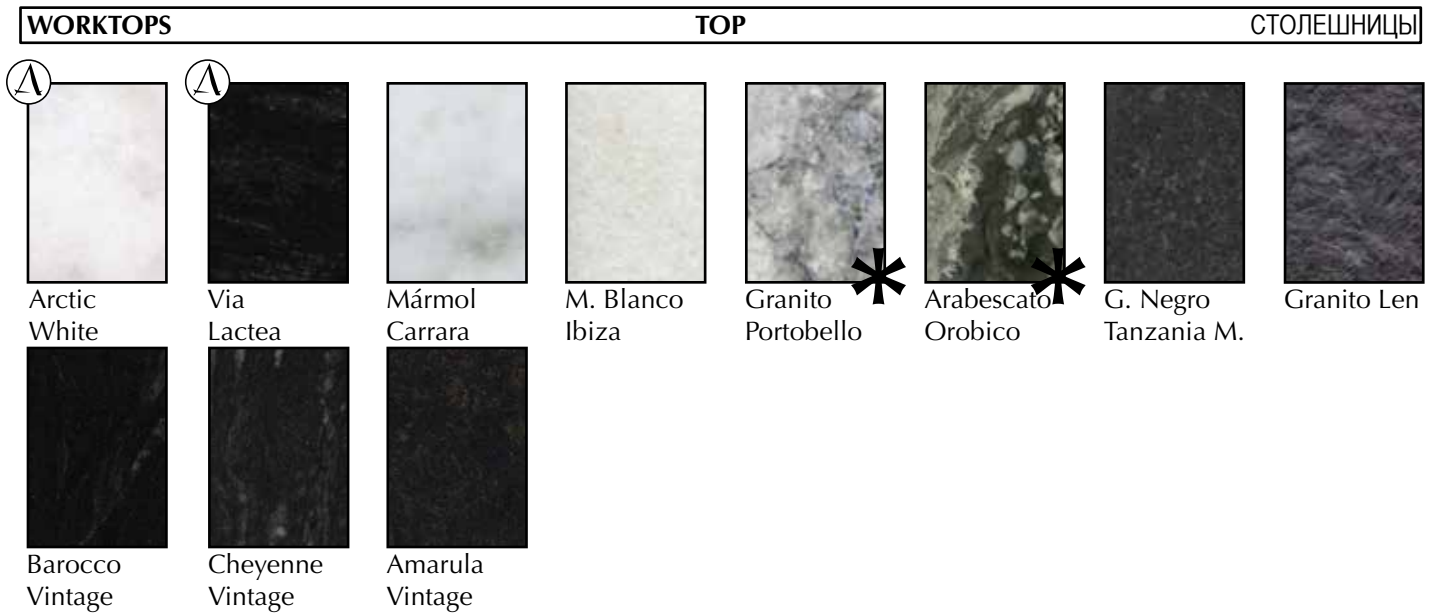

\* Maximum length recommended 120 cm. / 47<sup>1</sup>/<sub>4</sub>"

\* Lunghezza massima raccomandata 120 cm. / 47<sup>1</sup>/<sub>4</sub>"

\* Рекомендуемая максимальная длина — 120 см / 47<sup>1</sup>/<sub>4</sub>"

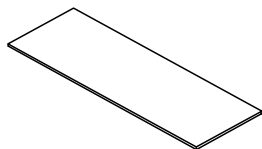

**STONE WORKTOPS**
**DEPTH 500MM / 19<sup>5/8</sup>"**

-Worktop.  
-Тор.  
-Столешница.

MEASURES	FINISHES	SAP	POINTS
0000-0460x20x500 / 0-18 <sup>1/8</sup> x0 <sup>3/4</sup> x19 <sup>5/8</sup>	G1	700009480	307
	G2	700009481	394
	G3	700009482	462
	G4	700009483	539
0461-0760x20x500 / 18 <sup>1/8</sup> -29 <sup>7/8</sup> x0 <sup>3/4</sup> x19 <sup>5/8</sup>	G1	700009485	406
	G2	700009486	549
	G3	700009487	661
	G4	700009488	788
0761-1060x20x500 / 30-41 <sup>3/4</sup> x0 <sup>3/4</sup> x19 <sup>5/8</sup>	G1	700009495	505
	G2	700009496	705
	G3	700009497	860
	G4	700009498	1038
1061-1360x20x500 / 41 <sup>3/4</sup> -53 <sup>1/2</sup> x0 <sup>3/4</sup> x19 <sup>5/8</sup>	G1	700009500	616
	G2	700009501	873
	G3	700009502	1073
	G4	700009503	1301
1361-1660x20x500 / 53 <sup>5/8</sup> -65 <sup>3/8</sup> x0 <sup>3/4</sup> x19 <sup>5/8</sup>	G1	700009505	715
	G2	700009506	1028
	G3	700009507	1272
	G4	700009508	1550
1661-1960x20x500 / 65 <sup>3/8</sup> -77 <sup>1/8</sup> x0 <sup>3/4</sup> x19 <sup>5/8</sup>	G1	700009510	827
	G2	700009511	1197
	G3	700009512	1485
	G4	700009513	1813
1961-2260x20x500 / 77 <sup>1/4</sup> -89x0 <sup>3/4</sup> x19 <sup>5/8</sup>	G1	700009515	925
	G2	700009516	1352
	G3	700009517	1684
	G4	700009518	2063
2261-2710x20x500 / 89-106 <sup>3/4</sup> x0 <sup>3/4</sup> x19 <sup>5/8</sup>	G1	700009520	1072
	G2	700009521	1583
	G3	700009522	1981
	G4	700009523	2435

POINTS FOR DRILLED ON STONE COUNTERTOPS  
PUNTI CORRISPONDENTI AI DIVERSI ATTACCHI PER TOP IN STONE  
ПОЗИЦИИ ДЛЯ МРАМОРНЫХ СТОЛЕШНИЦ С ПРОСВЕРЛЕННЫМИ ОТВЕРСТИЯМИ

BASIN ON COUNTERTOP LAVABO SOPRATOP РАКОВИНА НА СТОЛЕШНИЦЕ	POINTS/UND.	35
BASIN SOTTO BOX / NOVA LAVABO SOTTO BOX / NOVA РАКОВИНА SOTTO BOX / NOVA	POINTS/UND.	114
DEPTH REDUCTION RIDUZIONE FONDO УМЕНЬШЕНИЕ ГЛУБИНЫ	POINTS/UND.	42

**FINISHES:**

**G-2: Bottega Acero / Aged Clay / Aged Dark / Bottega Antracita.**

**G-3: Liem Grey Nature / Liem Dark Nature.**

**G-4: Glem White / Paonazzo Biondo Pulido / Invisible White Pulido.**

**WORKTOPS** **TOP** **СТОЛЕШНИЦЫ**



Glem White



Paonazzo Biondo P.



Bottega Acero



Invisible White Pulido



Aged Clay



Liem Grey Nature



Aged Dark



Bottega Antracita



Liem Dark Nature

SOTTO Basin  
Lavabo SOTTO  
РАКОВИНА SOTTO

BASIN SOTTO KRION		
LAVABO SOTTO KRION	100220388	738
РАКОВИНА SOTTO KRION		
BASIN SOTTO KRION WITH OVERFLOW		
L. SOTTO KRION CON TROPPOPIENO	100220387	770
РАКОВИНА SOTTO KRION С ПЕРЕЛИВОМ		
BASIN SOTTO MINI KRION		
LAVABO SOTTO MINI KRION	100220411	726
РАКОВИНА SOTTO MINI KRION		
B. SOTTO MINI KRION WITH OVERFLOW		
L. SOTTO MINI KRION CON TROPPOPIENO	100220410	758
РАКОВИНА SOTTO MINI KRION С ПЕРЕЛИВОМ		
SOTTO BOX. CERAMIC BASIN.		
SOTTO BOX. LAVABO IN CERAMICA.	100036217	260
SOTTO BOX. КЕРАМИЧЕСКАЯ РАКОВИНА.		
SOTTO NOVA 50. CERAMIC BASIN.		
SOTTO NOVA 50. LAVABO IN CERAMICA.	BPS ≥ 60	100241696
SOTTO NOVA 50. КЕРАМИЧЕСКАЯ РАКОВИНА.		253
SOTTO NOVA 60. CERAMIC BASIN.		
SOTTO NOVA 60. LAVABO IN CERAMICA.	BPS ≥ 80	100286592
SOTTO NOVA 60. КЕРАМИЧЕСКАЯ РАКОВИНА.		370

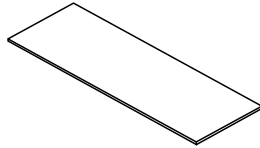
**XTONE WORKTOPS**
**DEPTH 500MM / 19<sup>5/8</sup>"**

-Worktop.  
-Тор.  
-Столешница.

MEASURES	FINISHES	SAP	POINTS
0000-0460x12x500 / 0-18 <sup>1/8</sup> x0 <sup>1/2</sup> x19 <sup>5/8</sup>	G2	700023390	448
	G3	700023430	481
	G4	700023442	513
0461-0760x12x500 / 18 <sup>1/8</sup> -29 <sup>7/8</sup> x0 <sup>1/2</sup> x19 <sup>5/8</sup>	G2	700023402	613
	G3	700023440	667
	G4	700023431	720
0761-1060x12x500 / 30-41 <sup>3/4</sup> x0 <sup>1/2</sup> x19 <sup>5/8</sup>	G2	700023441	778
	G3	700023413	853
	G4	700023414	928
1061-1360x12x500 / 41 <sup>3/4</sup> -53 <sup>1/2</sup> x0 <sup>1/2</sup> x19 <sup>5/8</sup>	G2	700023421	957
	G3	700023432	1053
	G4	700023415	1149
1361-1660x12x500 / 53 <sup>5/8</sup> -65 <sup>3/8</sup> x0 <sup>1/2</sup> x19 <sup>5/8</sup>	G2	700023433	1128
	G3	700023443	1245
	G4	700023422	1362
1661-1960x12x500 / 65 <sup>3/8</sup> -77 <sup>1/8</sup> x0 <sup>1/2</sup> x19 <sup>5/8</sup>	G2	700023391	1308
	G3	700023392	1446
	G4	700023400	1584
1961-2260x12x500 / 77 <sup>1/4</sup> -89x0 <sup>1/2</sup> x19 <sup>5/8</sup>	G2	700023393	1472
	G3	700023410	1632
	G4	700023411	1791
2261-2710x12x500 / 89-106 <sup>3/4</sup> x0 <sup>1/2</sup> x19 <sup>5/8</sup>	G2	700023412	1721
	G3	700023401	1912
	G4	700023420	2103

**POINTS FOR DRILLED ON XTONE COUNTERTOPS**
**PUNTI CORRISPONDENTI AI DIVERSI ATTACCHI PER TOP IN XTONE**
**ПОЗИЦИИ ДЛЯ СТОЛЕШНИЦ ИЗ МАТЕРИАЛА ХТОНЕ С ПРОСВЕРЛЕННЫМИ ОТВЕРСТИЯМИ**
**BASIN ON COUNTERTOP**
**LAVABO SOPRATOP**
**РАКОВИНА НА СТОЛЕШНИЦЕ**
**POINTS/UND. 35**
**BASIN SOTTO**
**LAVABO SOTTO**
**РАКОВИНА SOTTO**
**POINTS/UND. 114**
**DEPTH REDUCTION**
**RIDUZIONE FONDO**
**УМЕНЬШЕНИЕ ГЛУБИНЫ**
**POINTS/UND. 42**

500mm./19<sup>5</sup>/<sub>8</sub>"

KRION®

KRION LUX WORKTOPS

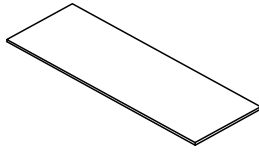
DEPTH 500MM / 19<sup>5</sup>/<sub>8</sub>"

-Worktop.  
-Тор.  
-Столешница.

MEASURES	FINISHES	SAP	POINTS
0000-0460x12x500 / 0-18 <sup>1</sup> / <sub>8</sub> x0 <sup>1</sup> / <sub>2</sub> x19 <sup>5</sup> / <sub>8</sub>		700009484	228
0461-0760x12x500 / 18 <sup>1</sup> / <sub>8</sub> -29 <sup>7</sup> / <sub>8</sub> x0 <sup>1</sup> / <sub>2</sub> x19 <sup>5</sup> / <sub>8</sub>		700009489	334
0761-1060x12x500 / 30-41 <sup>3</sup> / <sub>4</sub> x0 <sup>1</sup> / <sub>2</sub> x19 <sup>5</sup> / <sub>8</sub>		700009499	462
1061-1360x12x500 / 41 <sup>3</sup> / <sub>4</sub> -53 <sup>1</sup> / <sub>2</sub> x0 <sup>1</sup> / <sub>2</sub> x19 <sup>5</sup> / <sub>8</sub>	KRION LUX	700009504	567
1361-1660x12x500 / 53 <sup>5</sup> / <sub>8</sub> -65 <sup>3</sup> / <sub>8</sub> x0 <sup>1</sup> / <sub>2</sub> x19 <sup>5</sup> / <sub>8</sub>		700009509	666
1661-1960x12x500 / 65 <sup>3</sup> / <sub>8</sub> -77 <sup>1</sup> / <sub>8</sub> x0 <sup>1</sup> / <sub>2</sub> x19 <sup>5</sup> / <sub>8</sub>		700009514	776
1961-2260x12x500 / 77 <sup>1</sup> / <sub>4</sub> -89x0 <sup>1</sup> / <sub>2</sub> x19 <sup>5</sup> / <sub>8</sub>		700009519	904
2261-2710x12x500 / 89-106 <sup>3</sup> / <sub>4</sub> x0 <sup>1</sup> / <sub>2</sub> x19 <sup>5</sup> / <sub>8</sub>		700009524	1054

POINTS FOR DRILLED ON KRION COUNTERTOPS

PUNTI CORRISPONDENTI AI DIVERSI ATTACCHI PER TOP IN KRION

ПОЗИЦИИ ДЛЯ СТОЛЕШНИЦ ИЗ МАТЕРИАЛА KRION С ПРОСВЕРЛЕННЫМИ ОТВЕРСТИЯМИ

BASIN ON COUNTERTOP

LAVABO SOPRATOP

POINTS/UND. 63

РАКОВИНА НА СТОЛЕШНИЦЕ

BASIN SOTTO KRION

LAVABO SOTTO KRION

BASIN INCL.

POINTS/UND. 781

РАКОВИНА SOTTO KRION

BASIN SOTTO KRION WITH OVERFLOW

L. SOTTO KRION CON TROPPOPIENO

BASIN INCL.

POINTS/UND. 833

РАКОВИНА SOTTO KRION С ПЕРЕЛИВОМ

DEPTH REDUCTION

RIDUZIONE FONDO

POINTS/UND. 35

УМЕНЬШЕНИЕ ГЛУБИНЫ

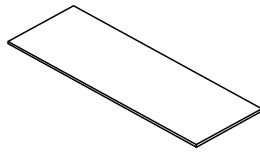

-Worktop.  
-Тор.  
-Столешница.

MEASURES	FINISHES	SAP	POINTS
0000-0460x12x360 / 0-18 <sup>1</sup> / <sub>8</sub> x0 <sup>1</sup> / <sub>2</sub> x14 <sup>1</sup> / <sub>8</sub>		700014940	177
0461-0760x12x360 / 18 <sup>1</sup> / <sub>8</sub> -29 <sup>7</sup> / <sub>8</sub> x0 <sup>1</sup> / <sub>2</sub> x14 <sup>1</sup> / <sub>8</sub>		700014946	265
0761-1060x12x360 / 30-41 <sup>3</sup> / <sub>4</sub> x0 <sup>1</sup> / <sub>2</sub> x14 <sup>1</sup> / <sub>8</sub>		700014947	351
1061-1360x12x360 / 41 <sup>3</sup> / <sub>4</sub> -53 <sup>1</sup> / <sub>2</sub> x0 <sup>1</sup> / <sub>2</sub> x14 <sup>1</sup> / <sub>8</sub>	KRION LUX	700014941	434
1361-1660x12x360 / 53 <sup>5</sup> / <sub>8</sub> -65 <sup>3</sup> / <sub>8</sub> x0 <sup>1</sup> / <sub>2</sub> x14 <sup>1</sup> / <sub>8</sub>		700014942	516
1661-1960x12x360 / 65 <sup>3</sup> / <sub>8</sub> -77 <sup>1</sup> / <sub>8</sub> x0 <sup>1</sup> / <sub>2</sub> x14 <sup>1</sup> / <sub>8</sub>		700014943	609
1961-2260x12x360 / 77 <sup>1</sup> / <sub>4</sub> -89x0 <sup>1</sup> / <sub>2</sub> x14 <sup>1</sup> / <sub>8</sub>		700014944	691
2261-2710x12x360 / 89-106 <sup>3</sup> / <sub>4</sub> x0 <sup>1</sup> / <sub>2</sub> x14 <sup>1</sup> / <sub>8</sub>		700014945	815

## POINTS FOR DRILLED ON KRION COUNTERTOPS

PUNTI CORRISPONDENTI AI DIVERSI ATTACCHI PER TOP IN KRION

ПОЗИЦИИ ДЛЯ СТОЛЕШНИЦ ИЗ МАТЕРИАЛА KRION С ПРОСВЕРЛЕННЫМИ ОТВЕРСТИЯМИ

BASIN ON COUNTERTOP

LAVABO SOPRATOP

РАКОВИНА НА СТОЛЕШНИЦЕ

POINTS/UND. 63

BASIN SOTTO MINI KRION

LAVABO SOTTO MINI KRION

РАКОВИНА SOTTO MINI KRION

BASIN INCL.

POINTS/UND. 770

B. SOTTO MINI KRION WITH OVERFLOW

L. SOTTO MINI KRION CON TRORPROPIENO

РАКОВИНА SOTTO MINI KRION С ПЕРЕЛИВОМ

BASIN INC.

POINTS/UND. 822

## THERMOFORMED KRION WORKTOPS

DEPTH 500MM / 19<sup>5/8</sup>"

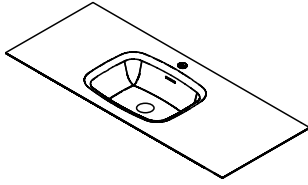

- Krion worktop thermoformed.
- \*For series DESS and CICLO +125 points.
- Top Krion termoformato.
- \*Per serie DESS e CICLO +125 punti.
- Термоформованные столешницы Krion.
- \*Для серий DESS и CICLO +125 позиций.

MEASURES	FINISHES	SAP	POINTS
0600-0760x12x500 / 23 <sup>5/8</sup> -29 <sup>7/8</sup> x0 <sup>1/2</sup> x19 <sup>5/8</sup>	KRION	700018403	0932*
0761-1060x12x500 / 30-41 <sup>3/4</sup> x0 <sup>1/2</sup> x19 <sup>5/8</sup>		700018423	1322*
1061-1360x12x500 / 41 <sup>3/4</sup> -53 <sup>1/2</sup> x0 <sup>1/2</sup> x19 <sup>5/8</sup>		700018431	1356*
1361-1660x12x500 / 53 <sup>5/8</sup> -65 <sup>3/8</sup> x0 <sup>1/2</sup> x19 <sup>5/8</sup>		700018433	1832*
1661-1960x12x500 / 65 <sup>3/8</sup> -77 <sup>1/8</sup> x0 <sup>1/2</sup> x19 <sup>5/8</sup>		700018412	2069*
1961-2260x12x500 / 77 <sup>1/4</sup> -89x0 <sup>1/2</sup> x19 <sup>5/8</sup>		700018402	2273*
2261-2710x12x500 / 89-106 <sup>3/4</sup> x0 <sup>1/2</sup> x19 <sup>5/8</sup>		700018434	2613*

## THERMOFORMED KRION WORKTOPS

DEPTH 500MM / 19<sup>5/8</sup>"

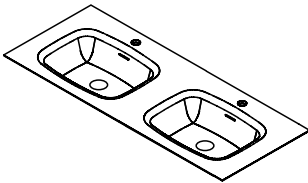

- Krion worktop thermoformed.
- \*For series DESS and CICLO +125 points.
- Top Krion termoformato.
- \*Per serie DESS e CICLO +125 punti.
- Термоформованные столешницы Krion.
- \*Для серий DESS и CICLO +125 позиций.

MEASURES	FINISHES	SAP	POINTS
1200-1360x12x500 / 47 <sup>1/4</sup> -53 <sup>1/2</sup> x0 <sup>1/2</sup> x19 <sup>5/8</sup>	KRION	700018424	1951*
1361-1660x12x500 / 53 <sup>5/8</sup> -65 <sup>3/8</sup> x0 <sup>1/2</sup> x19 <sup>5/8</sup>		700018435	2189*
1661-1960x12x500 / 65 <sup>3/8</sup> -77 <sup>1/8</sup> x0 <sup>1/2</sup> x19 <sup>5/8</sup>		700018432	2427*
1961-2260x12x500 / 77 <sup>1/4</sup> -89x0 <sup>1/2</sup> x19 <sup>5/8</sup>		700018422	2631*
2261-2710x12x500 / 89-106 <sup>3/4</sup> x0 <sup>1/2</sup> x19 <sup>5/8</sup>		700018401	3004*

## CLIK CLACK POP UP WASTE KRION



- Click-clack valve for sinks/basins with and without overflow. KRION.
- Valvola clik-clack per lavabi con et senza troppopieno. KRION.
- Донный клапан clik-clack для раковин с/без сливом-переливом. KRION.

SAP	POINTS
100174610	112

## DESG.300 MINI



- Drainage chrome.
- Scarico cromato.
- Дренаж хромированный.

FINISHES	SAP	POINTS
Cromado	100036255	103

## KRION WORKTOPS TOMO

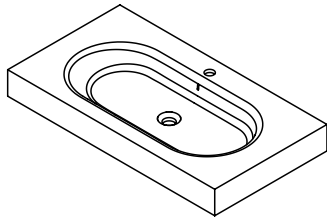

-Worktop.

-Requires for installation valve SAP100174610, 112 P.

-Top.

-Richiede valvola SAP100174610, 112 P.

-Столешница.

-Требуется установка клапана SAP100174610, 112 P.

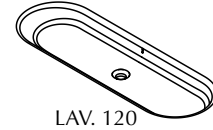

MEASURES	FINISHES	SAP	POINTS
60x10x49 / 23 <sup>5/8</sup> x3 <sup>7/8</sup> x19 <sup>1/4</sup>	KRION LAV.60	100278371	1548
80x10x49 / 31 <sup>1/2</sup> x3 <sup>7/8</sup> x19 <sup>1/4</sup>	KRION LAV.60	100278372	1706
90x10x49 / 35 <sup>3/8</sup> x3 <sup>7/8</sup> x19 <sup>1/4</sup>	KRION LAV.90	100278373	1869
100x10x49 / 39 <sup>3/8</sup> x3 <sup>7/8</sup> x19 <sup>1/4</sup>	KRION LAV.90	100278367	1958
120x10x49 / 47 <sup>1/4</sup> x3 <sup>7/8</sup> x19 <sup>1/4</sup>	KRION LAV.90	100278370	2270
120x10x49 / 47 <sup>1/4</sup> x3 <sup>7/8</sup> x19 <sup>1/4</sup>	KRION LAV.120	100278369	2390
120x10x49 / 47 <sup>1/4</sup> x3 <sup>7/8</sup> x19 <sup>1/4</sup>	KRION LAV.120 2G.	100278368	2422
120x10x49 / 47 <sup>1/4</sup> x3 <sup>7/8</sup> x19 <sup>1/4</sup>	KRION D/S LAV.60	100278821	2532
120x10x49 / 47 <sup>1/4</sup> x3 <sup>7/8</sup> x19 <sup>1/4</sup>	KRION LAV. DX 90	100278840	2330
120x10x49 / 47 <sup>1/4</sup> x3 <sup>7/8</sup> x19 <sup>1/4</sup>	KRION LAV. SX 90	100278841	2330
60x10x49 / 23 <sup>5/8</sup> x3 <sup>7/8</sup> x19 <sup>1/4</sup>	<b>2 LEGS</b> / KRION LAV.60	100278386	1710
80x10x49 / 31 <sup>1/2</sup> x3 <sup>7/8</sup> x19 <sup>1/4</sup>	<b>2 LEGS</b> / KRION LAV.60	100278389	1914
90x10x49 / 35 <sup>3/8</sup> x3 <sup>7/8</sup> x19 <sup>1/4</sup>	<b>2 LEGS</b> / KRION LAV.90	100278392	2080
100x10x49 / 39 <sup>3/8</sup> x3 <sup>7/8</sup> x19 <sup>1/4</sup>	<b>2 LEGS</b> / KRION LAV.90	100278374	2134
120x10x49 / 47 <sup>1/4</sup> x3 <sup>7/8</sup> x19 <sup>1/4</sup>	<b>2 LEGS</b> / KRION LAV.90	100278377	2387
120x10x49 / 47 <sup>1/4</sup> x3 <sup>7/8</sup> x19 <sup>1/4</sup>	<b>2 LEGS</b> / KRION LAV.120	100278380	2594
120x10x49 / 47 <sup>1/4</sup> x3 <sup>7/8</sup> x19 <sup>1/4</sup>	<b>2 LEGS</b> / KRION LAV.120 2G.	100278381	2607
120x10x49 / 47 <sup>1/4</sup> x3 <sup>7/8</sup> x19 <sup>1/4</sup>	<b>2 LEGS</b> / KRION D/S LAV.60	100278832	2684
120x10x49 / 47 <sup>1/4</sup> x3 <sup>7/8</sup> x19 <sup>1/4</sup>	<b>2 LEGS</b> / KRION LAV. DX 90	100278822	2491
120x10x49 / 47 <sup>1/4</sup> x3 <sup>7/8</sup> x19 <sup>1/4</sup>	<b>2 LEGS</b> / KRION LAV. SX 90	100278779	2491
60x10x49 / 23 <sup>5/8</sup> x3 <sup>7/8</sup> x19 <sup>1/4</sup>	<b>1 LEG DX</b> / KRION LAV.60	100278387	1616
80x10x49 / 31 <sup>1/2</sup> x3 <sup>7/8</sup> x19 <sup>1/4</sup>	<b>1 LEG DX</b> / KRION LAV.60	100278390	1785
90x10x49 / 35 <sup>3/8</sup> x3 <sup>7/8</sup> x19 <sup>1/4</sup>	<b>1 LEG DX</b> / KRION LAV.90	100278393	1951
100x10x49 / 39 <sup>3/8</sup> x3 <sup>7/8</sup> x19 <sup>1/4</sup>	<b>1 LEG DX</b> / KRION LAV.90	100278375	2036
120x10x49 / 47 <sup>1/4</sup> x3 <sup>7/8</sup> x19 <sup>1/4</sup>	<b>1 LEG DX</b> / KRION LAV.90	100278378	2378
120x10x49 / 47 <sup>1/4</sup> x3 <sup>7/8</sup> x19 <sup>1/4</sup>	<b>1 LEG DX</b> / KRION LAV.120	100278384	2498
120x10x49 / 47 <sup>1/4</sup> x3 <sup>7/8</sup> x19 <sup>1/4</sup>	<b>1 LEG DX</b> / KRION LAV.120 2G.	100278382	2514
120x10x49 / 47 <sup>1/4</sup> x3 <sup>7/8</sup> x19 <sup>1/4</sup>	<b>1 LEG DX</b> / KRION D/S LAV.60	100278813	2656
120x10x49 / 47 <sup>1/4</sup> x3 <sup>7/8</sup> x19 <sup>1/4</sup>	<b>1 LEG DX</b> / KRION LAV. DX 90	100278848	2438
60x10x49 / 23 <sup>5/8</sup> x3 <sup>7/8</sup> x19 <sup>1/4</sup>	<b>1 LEG SX</b> / KRION LAV.60	100278388	1616
80x10x49 / 31 <sup>1/2</sup> x3 <sup>7/8</sup> x19 <sup>1/4</sup>	<b>1 LEG SX</b> / KRION LAV.60	100278391	1785
90x10x49 / 35 <sup>3/8</sup> x3 <sup>7/8</sup> x19 <sup>1/4</sup>	<b>1 LEG SX</b> / KRION LAV.90	100278394	1951
100x10x49 / 39 <sup>3/8</sup> x3 <sup>7/8</sup> x19 <sup>1/4</sup>	<b>1 LEG SX</b> / KRION LAV.90	100278376	2036
120x10x49 / 47 <sup>1/4</sup> x3 <sup>7/8</sup> x19 <sup>1/4</sup>	<b>1 LEG SX</b> / KRION LAV.90	100278379	2378
120x10x49 / 47 <sup>1/4</sup> x3 <sup>7/8</sup> x19 <sup>1/4</sup>	<b>1 LEG SX</b> / KRION LAV.120	100278385	2498
120x10x49 / 47 <sup>1/4</sup> x3 <sup>7/8</sup> x19 <sup>1/4</sup>	<b>1 LEG SX</b> / KRION LAV.120 2G.	100278383	2514
120x10x49 / 47 <sup>1/4</sup> x3 <sup>7/8</sup> x19 <sup>1/4</sup>	<b>1 LEG SX</b> / KRION D/S LAV.60	100278833	2656
120x10x49 / 47 <sup>1/4</sup> x3 <sup>7/8</sup> x19 <sup>1/4</sup>	<b>1 LEG SX</b> / KRION LAV. SX 90	100278830	2438



## LEG FOR KRION WORKTOPS TOMO

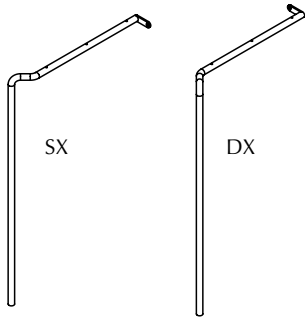

-Leg.  
-Piedini.  
-Hora.

MEASURES (HxL)	FINISHES	SAP	POINTS
88x34 <sup>5/8</sup>	<b>DX LEG. METAL SABLE</b>	100278410	0363
	<b>SX LEG. METAL SABLE</b>	100278411	0363

## KRION WORKTOP LAST SOTTO

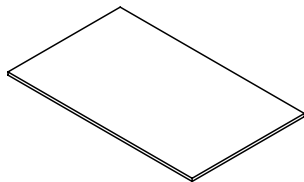

-Worktop.  
-Top.  
-Столешница.

-Requires for installation valve **SAP100174610, 112 P.**  
-Richiede valvola **SAP100174610, 112 P.**  
-Требуется установка клапана **SAP100174610, 112 P.**



MEASURES	FINISHES	SAP	POINTS
0600-0760x12x490 / 23 <sup>5/8</sup> -29 <sup>7/8</sup> x0 <sup>1/2</sup> x19 <sup>1/4</sup>		700028100	656
0761-1060x12x490 / 30-41 <sup>3/4</sup> x0 <sup>1/2</sup> x19 <sup>1/4</sup>		700028101	906
1061-1360x12x490 / 41 <sup>3/4</sup> -53 <sup>1/2</sup> x0 <sup>1/2</sup> x19 <sup>1/4</sup>		700027725	1161
1361-1660x12x490 / 53 <sup>5/8</sup> -65 <sup>3/8</sup> x0 <sup>1/2</sup> x19 <sup>1/4</sup>	<b>KRION LUX</b>	700027726	1421
1661-1960x12x490 / 65 <sup>3/8</sup> -77 <sup>1/8</sup> x0 <sup>1/2</sup> x19 <sup>1/4</sup>		700027727	1657
1961-2260x12x490 / 77 <sup>1/4</sup> -89x0 <sup>1/2</sup> x19 <sup>1/4</sup>		700027728	1883
2261-2710x12x490 / 89-106 <sup>3/4</sup> x0 <sup>1/2</sup> x19 <sup>1/4</sup>		700027729	2200

## POINTS FOR DRILLED ON KRION COUNTERTOPS

PUNTI CORRISPONDENTI AI DIVERSI ATTACCHI PER TOP IN KRION

ПОЗИЦИИ ДЛЯ СТОЛЕШНИЦ ИЗ МАТЕРИАЛА КРИОН С ПРОСВЕРЛЕННЫМИ ОТВЕРСТИЯМИ

	MEASURES (HxLxW)				
	49,8x8,5x34,5 19 <sup>5/8</sup> x3 <sup>3/8</sup> x13 <sup>5/8</sup>	BASIN INCL.	BPS ≥ ↔ 60	POINTS/UND.	384
	72,4x8,5x34,5 28 <sup>1/2</sup> x3 <sup>3/8</sup> x13 <sup>5/8</sup>	BASIN INCL.	BPS ≥ ↔ 80	POINTS/UND.	496
	102,4x8,5x34,5 40 <sup>3/8</sup> x3 <sup>3/8</sup> x13 <sup>5/8</sup>	BASIN INCL.	BPS ≥ ↔ 120	POINTS/UND.	603





# skyline

Corner	284
Fase	292
Radio	298
Gap	304
Skill	310
Hem	316
Tuck	324
Nut	332
Bambu	338
Urban	346
Folk	354
Travat	362
Dock	370



The interpretation made in inches for the dimensions of the different items shown in the price list has been rounded to 1/8, however for a more accurate measurement please use millimetres or centimetres.

## Corner

<b>EXTERIOR FINISHES</b> FINITURE ESTERNE ОТДЕЛКА ДЛЯ НАРУЖНОГО ИСПОЛЬЗОВАНИЯ	<input checked="" type="checkbox"/> Laminate Laminato ЛАМИНАТ	<input type="checkbox"/> Matt lacquer Laccato opaco МАТОВЫЙ ЛАК	<input type="checkbox"/> Wood veneer Legno ДЕРЕВО
	<input type="checkbox"/> HPL Stratificato СЛОИСТАЯ	<input type="checkbox"/> Gloss lacquer Laccato lucido ГЛЯНЦЕВЫЙ ЛАК	
<b>INTERIOR FINISHES</b> FINITURE INTERNE ОТДЕЛКА ДЛЯ ВНУТРЕННЕГО ИСПОЛЬЗОВАНИЯ	<input checked="" type="checkbox"/> Laminate Laminato ЛАМИНАТ	<input type="checkbox"/> Wood veneer Legno ДЕРЕВО	<input type="checkbox"/> Aluminium+laminated base Alluminio + base in laminato Алюминий + основа из ламината
<b>HANDLES</b> MANIGLIE РУЧКИ	<input type="checkbox"/> Front handle Maniglia frontale a vista Декоративная передняя ручка	<input type="checkbox"/> Integrated metal handle Maniglia metallica integrata Встроенная металлическая ручка	<input checked="" type="checkbox"/> Integrated mechanized h. Maniglia integrata ricavata sul bordo Встроенная ручка по краю
	<input type="checkbox"/> Push handle Maniglia Push РУЧКИ Push		
<b>TYPE OF UNITS</b> TIPI DI MODULI ТИПЫ МОДУЛЕЙ	<input checked="" type="checkbox"/> Compact Compatto Компактная	<input type="checkbox"/> Modular Modulare Модульная	
<b>POSITION</b> POSIZIONE ПОЗИЦИЯ	<input checked="" type="checkbox"/> Wall-mounted Sospeso Подвесная	<input type="checkbox"/> Floor-mounted A terra Напольная	
<b>MEASURES (CM)</b> DIMENSIONI РАЗМЕРЫ	◀ 60 / 80 / 120 23 <sup>5/8</sup> / 31 <sup>1/2</sup> / 47 <sup>1/4</sup>	▲ 55 21 <sup>5/8</sup>	↘ 48,2 19
<b>WORKTOP &amp; BASIN OPTIONS</b> OPZIONI TOP E LAVABI ВАРИАНТЫ СТОЛЕШНИЦ И УМЫВАЛЬНЫХ РАКОВИН	<input type="checkbox"/> Bath serie's worktop / basin Lavabo / top della serie Серийная умывальная раковина / столешница	<input type="checkbox"/> Standard worktops Top standard Стандартные столешницы	<input checked="" type="checkbox"/> Worktop + integrated basin Encimera + lavabo integrato Столешница + встроенная умывальная раковина
	<input checked="" type="checkbox"/> Over-mounted basin Lavabo da appoggio Настольная умывальная раковина	<input type="checkbox"/> Under-mounted basin Lavabo sottopiano Умывальная раковина, встраиваемая в столешницу снизу	<input checked="" type="checkbox"/> Double basin as option Opzione doppia vasca Вариант с двойной чашей
<b>WORKTOP FINISHES</b> FINITURE TOP ОТДЕЛКА СТОЛЕШНИЦ	<input checked="" type="checkbox"/> Krion® worktop Top in KRION® Столешница KRION®	<input checked="" type="checkbox"/> Gel Coat worktop Top in Gel Coat Столешница с покрытием гелькоут	<input type="checkbox"/> Natural Stone worktop Top in pietra naturale Столешница из натурального камня.
	<input type="checkbox"/> Glass worktop Top in vetro Столешница из стекла	<input type="checkbox"/> Bath furniture finish worktop Top con la finitura del mobile Столешница с той же отделкой, что и консоль/тумба	
<b>BASIN FINISHES</b> FINITURE LAVABI ОТДЕЛКА УМЫВАЛЬНЫХ РАКОВИН	<input checked="" type="checkbox"/> Krion® basin Lavabo in Krion® Умывальная раковина из Krion®	<input checked="" type="checkbox"/> Gel Coat basin Lavabo Gelcoat Раковина Gelcoat	<input type="checkbox"/> Ceramic basin Lavabo in ceramica Керамическая умывальная раковина
	<input type="checkbox"/> Natural Stone basin Lavabo in pietra naturale Умывальная раковина из натурального камня.		
<b>ACCESSORIES</b> ACCESSORI АКСЕССУАРЫ	<input checked="" type="checkbox"/> Mirror Specchio Зеркало	<input type="checkbox"/> Wall-mounted module Modulo sospeso Подвесной модуль	<input type="checkbox"/> Tall cabinet Modulo colonna Высокий шкаф
	<input type="checkbox"/> Upper unit Modulo alto Верхний модуль	<input type="checkbox"/> Organizer Organizzatore Органайзер	<input type="checkbox"/> Shelves Mensola Полка
			<input type="checkbox"/> Accessories Accessori Аксессуары

# corner



Available in a Nogal Moon or Nogal Frost finish, this bathroom unit stands out for the design of its continuous draw pull, starting in the front of the unit and ending midway along the side. Another fascinating feature is its use of intarsia, with contrasting horizontal and vertical wood grain patterns, lending a revamped vintage air. Corner's interiors are equally worthy of mention, with a mitre-edged drawer and two inner drawers in a finish that contrasts with the exterior, affording ample storage space.

Mobile da bagno realizzato con finitura Nogal Moon o Nogal Frost. Spicca il frontale squadrato con maniglia incorniciata, una maniglia continua che dal frontale del mobile arriva fino a metà fiancata. Questo mobile è caratterizzato anche dal gioco di contrasto delle venature orizzontali e verticali, che conferisce al mobile contemporaneo un tocco di antico. In questo mobile è molto importante anche l'interno, che presenta un cassetto con presa a 45° e 2 cassetti interni con finitura a contrasto con l'esterno e che dispongono della capacità perfetta per riporre tutto quanto occorre.

Tumba per la vasca viene offerta con due tipi di finitura: Nogal Moon e Nogal Frost. La pannello anteriore ha superfici, disposte ad angolo retto — davanti e sul lato — con maniglia in forma di rientro. Si distingue per la combinazione di elementi in legno con venature orizzontali e verticali, che conferisce alla sedia un'aria di antichità. È importante anche l'organizzazione dello spazio, e in particolare il cassetto con cassetto a 45° e 2 cassetti interni, con finitura a contrasto con l'esterno, i quali contrastano con l'esterno. Tutto ciò garantisce un'ampia area di stoccaggio.



+info p.390

2923 Points  
**CORNER Nogal Frost**



+info p.390

2347 Points  
CORNER Nogal Moon

## FINISHES

LAMINATE

LAMINATO

ЛАМИНАТ



Nogal Frost



Nogal Moon



## WASH BASIN UNIT BPS

DEPTH 48,2CM / 19"

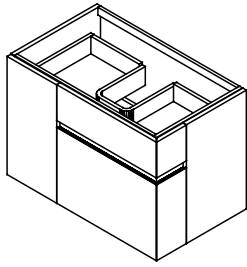

Wash basin unit.

Basi portalavabo.

Тумбочка под умывальник.

MEASURES (x)x(x)x(x))	FINISHES	SAP	POINTS
60x55x48,2 / 23 <sup>5/8</sup> x21 <sup>5/8</sup> x19	Nogal Frost	100292721	962
	Nogal Moon	100292722	962
80x55x48,2 / 31 <sup>1/2</sup> x21 <sup>5/8</sup> x19	Nogal Frost	100292695	1016
	Nogal Moon	100292706	1016
120x55x48,2 / 47 <sup>1/4</sup> x21 <sup>5/8</sup> x19	Nogal Frost	100292658	1329
	Nogal Moon	100292705	1329

BP

## MIRROR CORNER

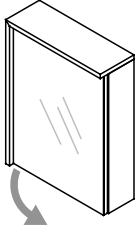
DEPTH 16,8CM / 6<sup>5/8</sup>"

-Upper unit with door and mirror front.

-Pensile con anta e frontale a specchio.

-Верхний блок с дверцей и зеркальным фасадом.

MEASURES (x)x(x)x(x))	FINISHES	SAP	POINTS
47x62x16,8 / 18 <sup>1/2</sup> x24 <sup>3/8</sup> x6 <sup>5/8</sup>	Nogal Frost	100292689	577
	Nogal Moon	100292659	577

## MIRROR CORNER

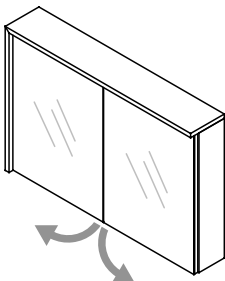
DEPTH 16,8CM / 6<sup>5/8</sup>"

-Upper unit with door and mirror front.

-Pensile con anta e frontale a specchio.

-Верхний блок с дверцей и зеркальным фасадом.

MEASURES (x)x(x)x(x))	FINISHES	SAP	POINTS
92x62x16,8 / 36 <sup>1/4</sup> x24 <sup>3/8</sup> x6 <sup>5/8</sup>	Nogal Frost	100292730	728
	Nogal Moon	100292731	728

ES

# corner

## TALL CABINET

DEPTH 30CM / 11<sup>3/4</sup>"

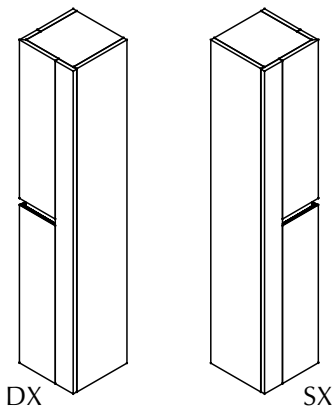

- Tall cabinet. DX / SX
- Modulo colonna. DX / SX
- Высокий шкаф. DX / SX

MC

MEASURES	FINISHES	SAP	POINTS
30x156x30 / 11 <sup>3/4</sup> x61 <sup>3/8</sup> x11 <sup>3/4</sup>	Nogal Frost	100296907	872
	Nogal Moon	100296924	872

## MIRROR CORNER

DEPTH 4CM / 1<sup>5/8</sup>"

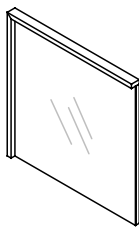

- Mirror.
- Specchio
- Зеркало.

ES

MEASURES	FINISHES	SAP	POINTS
47x62x4 / 18 <sup>1/2</sup> x24 <sup>3/8</sup> x1 <sup>5/8</sup>	Nogal Frost	100292740	298
	Nogal Moon	100292741	298
62x62x4 / 24 <sup>3/8</sup> x24 <sup>3/8</sup> x1 <sup>5/8</sup>	Nogal Frost	100292696	316
	Nogal Moon	100292720	316
106x62x4 / 41 <sup>3/4</sup> x24 <sup>3/8</sup> x1 <sup>5/8</sup>	Nogal Frost	100292714	379
	Nogal Moon	100292715	379

## SLIM BASIN

DEPTH 49CM / 19<sup>1/4</sup>"

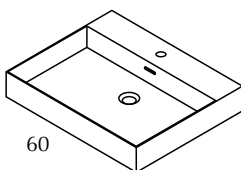

60

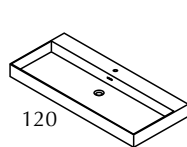

120

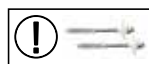

- GELCOAT basin with overflow.
- Requires for installation valve SAP 100200010, 72 P.
- Lavabo GELCOAT con troppopieno.
- Richiede valvola SAP 100200010, 72 P.
- Раковина GELCOAT с переливом.
- Требуется установка клапана SAP 100200010, 72 P.

LA

MEASURES	FINISHES	SAP	POINTS
60x10x49 / 23 <sup>5/8</sup> x3 <sup>7/8</sup> x19 <sup>1/4</sup>		100221199	596
80x10x49 / 31 <sup>1/2</sup> x3 <sup>7/8</sup> x19 <sup>1/4</sup>	GELCOAT	100221201	682
120x10x49 / 47 <sup>1/4</sup> x3 <sup>7/8</sup> x19 <sup>1/4</sup>		100221205	822
① FIXINGS / ANCLAJE PARED. 60/80/90/100 (1UND.) - 120 (2UNDS.)		250010391	9

## FIT BASIN

DEPTH 49CM / 19 1/4"

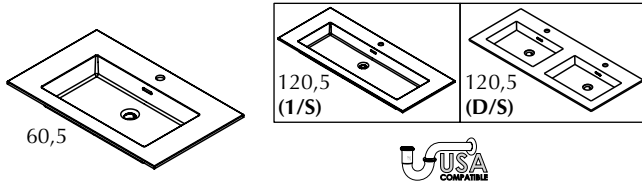

- GELCOAT basin with overflow.
- Requires for installation valve SAP 100200010, 72 P.
- Lavabo GELCOAT con troppopieno.
- Richiede valvola SAP 100200010, 72 P.
- Раковина GELCOAT с переливом.
- Требуется установка клапана SAP 100200010, 72 P.

MEASURES	FINISHES	SAP	POINTS
60,5x13,5x49 / 23 7/8x5 3/8x19 1/4	GELCOAT	100241712	427
80,5x13,5x49 / 31 3/4x5 3/8x19 1/4		100241723	532
120,5x13,5x49 / 47 1/2x5 3/8x19 1/4 (1/S)		100241693	794
120,5x13,5x49 / 47 1/2x5 3/8x19 1/4 (D/S)		100296392	898

## BASIN

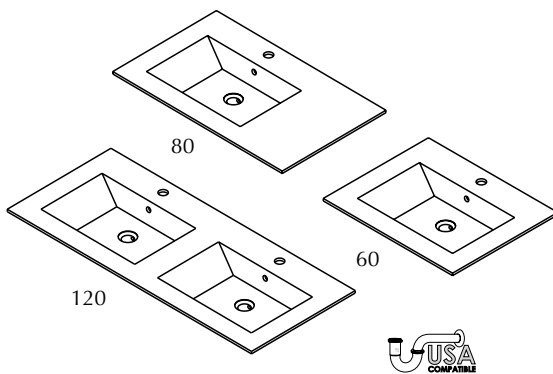

- GELCOAT basin with overflow.
- Requires for installation valve SAP 100200010, 72 P.
- Lavabo GELCOAT con troppopieno.
- Richiede valvola SAP 100200010, 72 P.
- Раковина GELCOAT с переливом.
- Требуется установка клапана SAP 100200010, 72 P.

MEASURES	FINISHES	SAP	POINTS
60,5x14,1x49,2 / 23 7/8x5 1/2x19 3/8	GELCOAT	100160956	0560
80,5x14,1x49,2 / 31 3/4x5 1/2x19 3/8		100160957	0582
120,5x14,1x49,2 / 47 1/2x5 1/2x19 3/8		100171860	0981

## KRION STONE WORKTOP

DEPTH 49,2CM / 19 3/8"

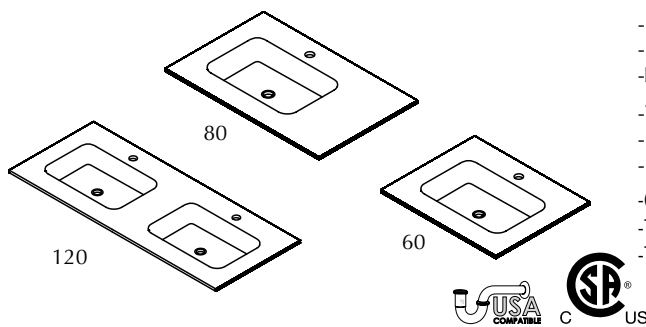

- KRION STONE Worktop with integrated basin.
- Requires for installation permanent valve SAP 100036254, 68 P.
- Requires drainage SAP 100036255, 103 P.
- Top in KRION STONE con lavabo integrato.
- Richiede valvola SAP 100036254, 68 P.
- Richiede scarico SAP 100036255, 103 P.
- Столешница KRION STONE со встроенной раковиной.
- Требуется установка постоянного клапана SAP 100036254, 68 P.
- Требуется дренаж SAP 100036255, 103 P.

MEASURES	FINISHES	SAP	POINTS
60,2x13x49,2 / 23 5/8x5 1/8x19 3/8	Krión STONE	100091017	617
80,2x13x49,2 / 31 1/2x5 1/8x19 3/8		100091018	660
120,2x13x49,2 / 47 3/8x5 1/8x19 3/8		100110448	1356



The interpretation made in inches for the dimensions of the different items shown in the price list has been rounded to 1/8, however for a more accurate measurement please use millimetres or centimetres.

## Fase

<b>EXTERIOR FINISHES</b> FINITURE ESTERNE ОТДЕЛКА ДЛЯ НАРУЖНОГО ИСПОЛЬЗОВАНИЯ	<input checked="" type="checkbox"/> Laminate Laminato ЛАМИНАТ	<input type="checkbox"/> Matt lacquer Laccato opaco МАТОВЫЙ ЛАК	<input type="checkbox"/> Wood veneer Legno ДЕРЕВО
	<input type="checkbox"/> HPL Stratificato СЛОИСТАЯ	<input type="checkbox"/> Gloss lacquer Laccato lucido ГЛЯНЦЕВЫЙ ЛАК	
<b>INTERIOR FINISHES</b> FINITURE INTERNE ОТДЕЛКА ДЛЯ ВНУТРЕННЕГО ИСПОЛЬЗОВАНИЯ	<input checked="" type="checkbox"/> Laminate Laminato ЛАМИНАТ	<input type="checkbox"/> Wood veneer Legno ДЕРЕВО	<input type="checkbox"/> Aluminium+laminated base Alluminio + base in laminato Алюминий + основа из ламината
	<input type="checkbox"/> Front handle Maniglia frontale a vista Декоративная передняя ручка	<input type="checkbox"/> Integrated metal handle Maniglia metallica integrata Встроенная металлическая ручка	<input checked="" type="checkbox"/> Integrated mechanized h. Maniglia integrata ricavata sul bordo Встроенная ручка по краю
<b>HANDLES</b> MANIGLIE РУЧКИ	<input type="checkbox"/> Push handle Maniglia Push РУЧКИ Push		
<b>TYPE OF UNITS</b> TIPI DI MODULI ТИПЫ МОДУЛЕЙ	<input checked="" type="checkbox"/> Compact Compatto Компактная	<input type="checkbox"/> Modular Modulare Модульная	
<b>POSITION</b> POSIZIONE ПОЗИЦИЯ	<input checked="" type="checkbox"/> Wall-mounted Sospeso Подвесная	<input type="checkbox"/> Floor-mounted A terra Напольная	
<b>MEASURES (CM)</b> DIMENSIONI РАЗМЕРЫ	60 / 80 / 120	40	46,5
	23 <sup>5/8</sup> / 31 <sup>1/2</sup> / 47 <sup>1/4</sup>	15 <sup>3/4</sup>	18 <sup>1/4</sup>
<b>WORKTOP &amp; BASIN OPTIONS</b> OPZIONI TOP E LAVABI ВАРИАНТЫ СТОЛЕШНИЦ И УМЫВАЛЬНЫХ РАКОВИН	<input type="checkbox"/> Bath serie's worktop / basin Lavabo / top della serie Серийная умывальная раковина / столешница	<input type="checkbox"/> Standard worktops Top standard Стандартные столешницы	<input checked="" type="checkbox"/> Worktop + integrated basin Encimera + lavabo integrato Столешница + встроенная умывальная раковина
	<input type="checkbox"/> Over-mounted basin Lavabo da appoggio Настольная умывальная раковина	<input type="checkbox"/> Under-mounted basin Lavabo sottopiano Умывальная раковина, встраиваемая в столешницу снизу	<input type="checkbox"/> Double basin as option Opzione doppia vasca Вариант с двойной чашей
<b>WORKTOP FINISHES</b> FINITURE TOP ОТДЕЛКА СТОЛЕШНИЦ	<input type="checkbox"/> Krion® worktop Top in KRION® Столешница KRION®	<input type="checkbox"/> Gel Coat worktop Top in Gel Coat Столешница с покрытием гелькоут	<input type="checkbox"/> Natural Stone worktop Top in pietra naturale Столешница из натурального камня.
	<input type="checkbox"/> Glass worktop Top in vetro Столешница из стекла	<input type="checkbox"/> Bath furniture finish worktop Top con la finitura del mobile Столешница с той же отделкой, что и консоль/тумба	
<b>BASIN FINISHES</b> FINITURE LAVABI ОТДЕЛКА УМЫВАЛЬНЫХ РАКОВИН	<input type="checkbox"/> Krion® basin Lavabo in Krion® Умывальная раковина из Krion®	<input type="checkbox"/> Gel Coat basin Lavabo Gelcoat Раковина Gelcoat	<input checked="" type="checkbox"/> Ceramic basin Lavabo in ceramica Керамическая умывальная раковина
	<input type="checkbox"/> Natural Stone basin Lavabo in pietra naturale Умывальная раковина из натурального камня.		
<b>ACCESSORIES</b> ACCESSORI АКСЕССУАРЫ	<input checked="" type="checkbox"/> Mirror Specchio Зеркало	<input type="checkbox"/> Wall-mounted module Modulo sospeso Подвесной модуль	<input type="checkbox"/> Tall cabinet Modulo colonna Высокий шкаф
	<input type="checkbox"/> Upper unit Modulo alto Верхний модуль	<input checked="" type="checkbox"/> Organizer Organizzatore Органайзер	<input type="checkbox"/> Shelves Mensola Полка
			<input type="checkbox"/> Accessories Accessori Аксессуары

# *fase*



Fase is a bathroom unit made of Sugi laminate. It has a simple yet distinctive design, with the draw pull positioned on one side, thanks to a space in the front that lends it a strong innovative appeal. The different compartments in its drawer are perfect for keeping the bathroom neat and well organized.

Il mobile da bagno Fase è prodotto in laminato Sugi, presenta linee semplici ma con un design diverso, dato che la maniglia integrata è inserita su un lato creando uno spazio frontale che ne rappresenta l'elemento distintivo.

L'interno del cassetto di Fase, grazie ai vari scomparti, è l'alleato perfetto per l'ordine e l'organizzazione nel bagno.

Fase — это мебель для ванной, отличающаяся лаконичными линиями и изготовленная из ламината Sugi. Она имеет необычный дизайн: ручка в виде выемки встроена в боковую сторону передней панели.

Выдвижной ящик Fase, имеющий различные отделения, поможет вам как следует организовать принадлежности, которые хранятся в ванной.



+info p.390



1542 Points  
FASE Sugi Black

## FINISHES

LAMINATE

LAMINATO

ЛАМИНАТ



Sugi Black



Blanco



## WASH BASIN UNIT BPS

DEPTH 46,5CM / 18<sup>1</sup>/<sub>4</sub>"

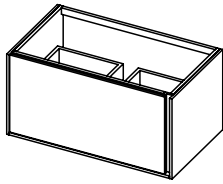

Wash basin unit. Organisation tray included.

Basi portalavabo. Include vassoio organizzatore.

Тумбочка под умывальник. Включает органайзер.



MEASURES (x x x)	FINISHES	SAP	POINTS
60x40x46,5 / 23 <sup>5</sup> / <sub>8</sub> x15 <sup>3</sup> / <sub>4</sub> x18 <sup>1</sup> / <sub>4</sub>	Sugi Black	100278397	0956
	Blanco	100278398	0956
80x40x46,5 / 31 <sup>1</sup> / <sub>2</sub> x15 <sup>3</sup> / <sub>4</sub> x18 <sup>1</sup> / <sub>4</sub>	Sugi Black	100278399	1022
	Blanco	100278400	1022
120x40x46,5 / 47 <sup>1</sup> / <sub>4</sub> x15 <sup>3</sup> / <sub>4</sub> x18 <sup>1</sup> / <sub>4</sub>	Sugi Black	100278395	1371
	Blanco	100278396	1371

fase

BP

## MIRROR FASE

DEPTH 4CM / 1<sup>5</sup>/<sub>8</sub>"

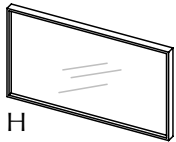

Mirror.

Specchio

Зеркало.

MEASURES (x x x)	FINISHES	SAP	POINTS
58,2x47x4 / 22 <sup>7</sup> / <sub>8</sub> x18 <sup>1</sup> / <sub>2</sub> x1 <sup>5</sup> / <sub>8</sub>	Sugi Black	100278357	0328
	Blanco	100278358	0328
78,2x47x4 / 30 <sup>3</sup> / <sub>4</sub> x18 <sup>1</sup> / <sub>2</sub> x1 <sup>5</sup> / <sub>8</sub>	Sugi Black	100278359	0349
	Blanco	100278360	0349
118,2x47x4 / 46 <sup>1</sup> / <sub>2</sub> x18 <sup>1</sup> / <sub>2</sub> x1 <sup>5</sup> / <sub>8</sub>	Sugi Black	100278355	0399
	Blanco	100278356	0399

ES

## FASE BASIN

61 / 24  
81 / 31<sup>7</sup>/<sub>8</sub>



-Basin.

-Lavabo.

-Раковина.

121 / 47<sup>5</sup>/<sub>8</sub>



MEASURES (x x x)	FINISHES	SAP	POINTS
61x17x46,5 / 24x6 <sup>3</sup> / <sub>4</sub> x18 <sup>1</sup> / <sub>4</sub>	White ceramic	100278365	0215
81x17x46,5 / 31 <sup>7</sup> / <sub>8</sub> x6 <sup>3</sup> / <sub>4</sub> x18 <sup>1</sup> / <sub>4</sub>		100278366	0260
121x17x46,5 / 47 <sup>5</sup> / <sub>8</sub> x6 <sup>3</sup> / <sub>4</sub> x18 <sup>1</sup> / <sub>4</sub>		100278364	0595

LA



The interpretation made in inches for the dimensions of the different items shown in the price list has been rounded to 1/8, however for a more accurate measurement please use millimetres or centimetres.

## Radio

<b>EXTERIOR FINISHES</b> FINITURE ESTERNE ОТДЕЛКА ДЛЯ НАРУЖНОГО ИСПОЛЬЗОВАНИЯ	<input checked="" type="checkbox"/> Laminate Laminato ЛАМИНАТ	<input type="checkbox"/> Matt lacquer Laccato opaco МАТОВЫЙ ЛАК	<input type="checkbox"/> Wood veneer Legno ДЕРЕВО
	<input type="checkbox"/> HPL Stratificato СЛОИСТАЯ	<input type="checkbox"/> Gloss lacquer Laccato lucido ГЛЯНЦЕВЫЙ ЛАК	
<b>INTERIOR FINISHES</b> FINITURE INTERNE ОТДЕЛКА ДЛЯ ВНУТРЕННЕГО ИСПОЛЬЗОВАНИЯ	<input checked="" type="checkbox"/> Laminate Laminato ЛАМИНАТ	<input type="checkbox"/> Wood veneer Legno ДЕРЕВО	<input type="checkbox"/> Aluminium+laminated base Alluminio + base in laminato Алюминий + основа из ламината
	<input type="checkbox"/> Front handle Maniglia frontale a vista Декоративная передняя ручка	<input type="checkbox"/> Integrated metal handle Maniglia metallica integrata Встроенная металлическая ручка	<input checked="" type="checkbox"/> Integrated mechanized h. Maniglia integrata ricavata sul bordo Встроенная ручка по краю
<b>HANDLES</b> MANIGLIE РУЧКИ	<input type="checkbox"/> Push handle Maniglia Push РУЧКИ Push		
<b>TYPE OF UNITS</b> TIPI DI MODULI ТИПЫ МОДУЛЕЙ	<input checked="" type="checkbox"/> Compact Compatto Компактная	<input type="checkbox"/> Modular Modulare Модульная	
<b>POSITION</b> POSIZIONE ПОЗИЦИЯ	<input checked="" type="checkbox"/> Wall-mounted Sospeso Подвесная	<input type="checkbox"/> Floor-mounted A terra Напольная	
<b>MEASURES (CM)</b> DIMENSIONI РАЗМЕРЫ	60 / 80 / 120	40	50
	23 <sup>5/8</sup> / 31 <sup>1/2</sup> / 47 <sup>1/4</sup>	15 <sup>3/4</sup>	19 <sup>5/8</sup>
<b>WORKTOP &amp; BASIN OPTIONS</b> OPZIONI TOP E LAVABI ВАРИАНТЫ СТОЛЕШНИЦ И УМЫВАЛЬНЫХ РАКОВИН	<input type="checkbox"/> Bath serie's worktop / basin Lavabo / top della serie Серийная умывальная раковина / столешница	<input type="checkbox"/> Standard worktops Top standard Стандартные столешницы	<input checked="" type="checkbox"/> Worktop + integrated basin Encimera + lavabo integrato Столешница + встроенная умывальная раковина
	<input type="checkbox"/> Over-mounted basin Lavabo da appoggio Настольная умывальная раковина	<input type="checkbox"/> Under-mounted basin Lavabo sottopiano Умывальная раковина, встраиваемая в столешницу снизу	<input type="checkbox"/> Double basin as option Opzione doppia vasca Вариант с двойной чашей
<b>WORKTOP FINISHES</b> FINITURE TOP ОТДЕЛКА СТОЛЕШНИЦ	<input checked="" type="checkbox"/> Krion® worktop Top in KRION® Столешница KRION®	<input type="checkbox"/> Gel Coat worktop Top in Gel Coat Столешница с покрытием гелькоут	<input type="checkbox"/> Natural Stone worktop Top in pietra naturale Столешница из натурального камня.
	<input type="checkbox"/> Glass worktop Top in vetro Столешница из стекла	<input type="checkbox"/> Bath furniture finish worktop Top con la finitura del mobile Столешница с той же отделкой, что и консоль/тумба	
<b>BASIN FINISHES</b> FINITURE LAVABI ОТДЕЛКА УМЫВАЛЬНЫХ РАКОВИН	<input checked="" type="checkbox"/> Krion® basin Lavabo in Krion® Умывальная раковина из Krion®	<input type="checkbox"/> Gel Coat basin Lavabo Gelcoat Раковина Gelcoat	<input type="checkbox"/> Ceramic basin Lavabo in ceramica Керамическая умывальная раковина
	<input type="checkbox"/> Natural Stone basin Lavabo in pietra naturale Умывальная раковина из натурального камня.		
<b>ACCESSORIES</b> ACCESSORI АКСЕССУАРЫ	<input checked="" type="checkbox"/> Mirror Specchio Зеркало	<input type="checkbox"/> Wall-mounted module Modulo sospeso Подвесной модуль	<input type="checkbox"/> Tall cabinet Modulo colonna Высокий шкаф
	<input type="checkbox"/> Upper unit Modulo alto Верхний модуль	<input checked="" type="checkbox"/> Organizer Organizzatore Органайзер	<input type="checkbox"/> Shelves Mensola Полка
			<input type="checkbox"/> Accessories Accessori Аксессуары

# radio



This bathroom unit is made of a kind of laminate that can be used to create curved edges, hence ensuring innovative end results. It stands out for its blend of simplicity and design appeal, with the assurance of quality synonymous with Gamadecor, perfect for the creation of unique looking bathrooms.

Questo mobile da bagno è prodotto con un tipo di laminazione con la quale si ottiene un effetto curvo sui bordi che dona un aspetto assolutamente inedito. Abbina alla perfezione semplicità e design per creare un bagno unico, con la qualità che caratterizza Gamadecor.

Эта мебель для ванной комнаты изготовлена из особого вида ламината, с помощью которого удалось создать фигурные края, придающие изделию исключительную новизну. Лаконичность и дизайн сливаются здесь воедино, делая ванную уникальным пространством — с высшим качеством, характерным для Gamadecor.



+info p.390



2189 Points  
**RADIO Olmo Light**

## FINISHES

LAMINATE

LAMINATO

ЛАМИНАТ



Olmo Dark



Olmo Light

## WASH BASIN UNIT BPS

DEPTH 50CM / 19<sup>5/8</sup>"

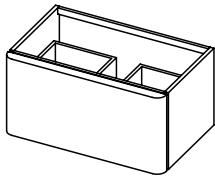

Wash basin unit. Organisation tray included.

Basi portalavabo. Include vassoio organizzatore.

Тумбочка под умывальник. Включает органайзер.



MEASURES	(xx)	FINISHES	SAP	POINTS
60x40x50 / 23 <sup>5/8</sup> x15 <sup>3/4</sup> x19 <sup>5/8</sup>		Olmo Dark	100278407	0950
		Olmo Light	100278406	0950
80x40x50 / 31 <sup>1/2</sup> x15 <sup>3/4</sup> x19 <sup>5/8</sup>		Olmo Dark	100278409	1028
		Olmo Light	100278408	1028
120x40x50 / 47 <sup>1/4</sup> x15 <sup>3/4</sup> x19 <sup>5/8</sup>		Olmo Dark	100278405	1383
		Olmo Light	100278404	1383

## MIRROR RADIO

DEPTH 20CM / 7<sup>7/8</sup>"

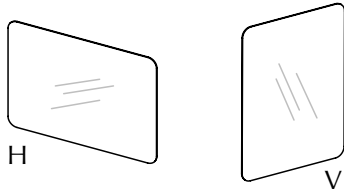

Mirror.

Specchio

Зеркало.

MEASURES	(xx)	SAP	POINTS
55x55x20 / 21 <sup>5/8</sup> x21 <sup>5/8</sup> x7 <sup>7/8</sup>		100278362	0223
75x55x20 / 29 <sup>1/2</sup> x21 <sup>5/8</sup> x7 <sup>7/8</sup>		100278363	0247
115x55x20 / 45 <sup>1/4</sup> x21 <sup>5/8</sup> x7 <sup>7/8</sup>		100278361	0391

## RADIO BASIN

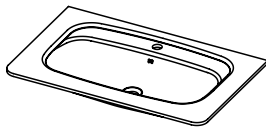

-KRION basin.

**-Requires valve SAP 100174610 112P.**

-Lavabo KRION.

**-Richiede valvola SAP 100174610 112P.**

-Раковина KRION.

**-Требуется постоянный перелив SAP 100174610 112P.**



MEASURES	(xx)	FINISHES	SAP	POINTS
60x12x50 / 23 <sup>5/8</sup> x4 <sup>3/4</sup> x19 <sup>5/8</sup>		KRION	100278353	0904
80x12x50 / 31 <sup>1/2</sup> x4 <sup>3/4</sup> x19 <sup>5/8</sup>			100278354	1069
120x12x50 / 47 <sup>1/4</sup> x4 <sup>3/4</sup> x19 <sup>5/8</sup>			100278352	1343

radio

BP

ES

LA



The interpretation made in inches for the dimensions of the different items shown in the price list has been rounded to 1/8, however for a more accurate measurement please use millimetres or centimetres.

## Gap

<b>EXTERIOR FINISHES</b> FINITURE ESTERNE ОТДЕЛКА ДЛЯ НАРУЖНОГО ИСПОЛЬЗОВАНИЯ	<input type="checkbox"/> Laminate Laminato ЛАМИНАТ	<input type="checkbox"/> Matt lacquer Laccato opaco МАТОВЫЙ ЛАК	<input type="checkbox"/> Wood veneer Legno ДЕРЕВО
	<input type="checkbox"/> HPL Stratificato СЛОИСТАЯ	<input type="checkbox"/> Gloss lacquer Laccato lucido ГЛЯНЦЕВЫЙ ЛАК	
<b>INTERIOR FINISHES</b> FINITURE INTERNE ОТДЕЛКА ДЛЯ ВНУТРЕННЕГО ИСПОЛЬЗОВАНИЯ	<input type="checkbox"/> Laminate Laminato ЛАМИНАТ	<input type="checkbox"/> Wood veneer Legno ДЕРЕВО	<input type="checkbox"/> Aluminium+laminated base Alluminio + base in laminato Алюминий + основа из ламината
	<input type="checkbox"/> Front handle Maniglia frontale a vista Декоративная передняя ручка	<input type="checkbox"/> Integrated metal handle Maniglia metallica integrata Встроенная металлическая ручка	<input type="checkbox"/> Integrated mechanized h. Maniglia integrata ricavata sul bordo Встроенная ручка по краю
<b>HANDLES</b> MANIGLIE РУЧКИ	<input type="checkbox"/> Push handle Maniglia Push РУЧКИ Push		
<b>TYPE OF UNITS</b> TIPI DI MODULI ТИПЫ МОДУЛЕЙ	<input checked="" type="checkbox"/> Compact Compatto Компактная	<input type="checkbox"/> Modular Modulare Модульная	
<b>POSITION</b> POSIZIONE ПОЗИЦИЯ	<input checked="" type="checkbox"/> Wall-mounted Sospeso Подвесная	<input type="checkbox"/> Floor-mounted A terra Напольная	
<b>MEASURES (CM)</b> DIMENSIONI РАЗМЕРЫ	60 / 90 / 120	40	48,2
	23 <sup>5/8</sup> / 35 <sup>3/8</sup> / 47 <sup>1/4</sup>	15 <sup>3/4</sup>	19
<b>WORKTOP &amp; BASIN OPTIONS</b> OPZIONI TOP E LAVABI ВАРИАНТЫ СТОЛЕШНИЦ И УМЫВАЛЬНЫХ РАКОВИН	<input type="checkbox"/> Bath serie's worktop / basin Lavabo / top della serie Серийная умывальная раковина / столешница	<input type="checkbox"/> Standard worktops Top standard Стандартные столешницы	<input checked="" type="checkbox"/> Worktop + integrated basin Encimera + lavabo integrato Столешница + встроенная умывальная раковина
	<input checked="" type="checkbox"/> Over-mounted basin Lavabo da appoggio Настольная умывальная раковина	<input type="checkbox"/> Under-mounted basin Lavabo sottopiano Умывальная раковина, встраиваемая в столешницу снизу	<input checked="" type="checkbox"/> Double basin as option Opzione doppia vasca Вариант с двойной чашей
<b>WORKTOP FINISHES</b> FINITURE TOP ОТДЕЛКА СТОЛЕШНИЦ	<input checked="" type="checkbox"/> Krion® worktop Top in KRION® Столешница KRION®	<input checked="" type="checkbox"/> Gel Coat worktop Top in Gel Coat Столешница с покрытием гелькоут	<input type="checkbox"/> Natural Stone worktop Top in pietra naturale Столешница из натурального камня.
	<input type="checkbox"/> Glass worktop Top in vetro Столешница из стекла	<input type="checkbox"/> Bath furniture finish worktop Top con la finitura del mobile Столешница с той же отделкой, что и консоль/тумба	
<b>BASIN FINISHES</b> FINITURE LAVABI ОТДЕЛКА УМЫВАЛЬНЫХ РАКОВИН	<input checked="" type="checkbox"/> Krion® basin Lavabo in Krion® Умывальная раковина из Krion®	<input checked="" type="checkbox"/> Gel Coat basin Lavabo Gelcoat Раковина Gelcoat	<input type="checkbox"/> Ceramic basin Lavabo in ceramica Керамическая умывальная раковина
	<input type="checkbox"/> Natural Stone basin Lavabo in pietra naturale Умывальная раковина из натурального камня.		
<b>ACCESSORIES</b> ACCESSORI АКСЕССУАРЫ	<input checked="" type="checkbox"/> Mirror Specchio Зеркало	<input type="checkbox"/> Wall-mounted module Modulo sospeso Подвесной модуль	<input type="checkbox"/> Tall cabinet Modulo colonna Высокий шкаф
	<input type="checkbox"/> Upper unit Modulo alto Верхний модуль	<input type="checkbox"/> Organizer Organizzatore Органайзер	<input type="checkbox"/> Shelves Mensola Полка
			<input type="checkbox"/> Accessories Accessori Аксессуары



## gap



Gap is a bathroom unit named after the large space in it normally occupied by drawers. With its 40cm-high steel frame and expanded metal mesh with a 3D texture, it brings a stylish, minimalist, industrial charm to bathrooms. Gap comes with a fully customizable washbasin, with the option of a natural stone, gelcoat or Krión model among others, contributing to the creation of the bathroom of your dreams.

Il nostro mobile da bagno Gap fa riferimento allo spazio, che in questo mobile da bagno invece essere occupato da cassetti, è contenuto in una struttura in profilato d'acciaio di 40 cm di altezza con una rete espansa con rilievo in 3D, per donare al bagno un aspetto elegante, minimal e industriale.

Gap dispone di un lavabo completamente personalizzabile scegliendo tra pietre naturali, gelcoat, Krión, ... per creare il mobile da bagno perfetto.

Наша мебель для ванных комнат Gap воплощает в себе идею пространства. В данном случае оно занято не выдвигаемыми ящиками, а конструкцией из стальных трубок 40-сантиметровой высоты и развернутой сеткой с трехмерным рельефом. Все это придает пространству элегантный, минималистичный вид в индустриальном стиле. Умывальную раковину Gap можно полностью персонализировать, выбрав натуральный камень, гелькоат, Krión и т. д. — чтобы создать идеальную мебель у себя в ванной.



5006 Points  
GAP Sable

+info p.391



+info p.391

1767 Points  
GAP Sable

## FINISHES



Sable

## WASH BASIN UNIT BPS

DEPTH 48,2CM / 19"

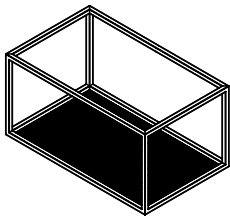

Wash basin unit.  
Basi portalavabo.  
Тумбочка под умывальник.

MEASURES	(xx)	FINISHES	SAP	POINTS
60x40x48,2	/ 23 <sup>5/8</sup> x15 <sup>3/4</sup> x19	Metal Sable	100278402	0515
90x40x48,2	/ 35 <sup>3/8</sup> x15 <sup>3/4</sup> x19		100278403	0536
120x40x48,2	/ 47 <sup>1/4</sup> x15 <sup>3/4</sup> x19		100278401	0647

## SLIM BASIN

DEPTH 49CM / 19<sup>1/4</sup>"

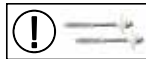
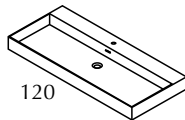
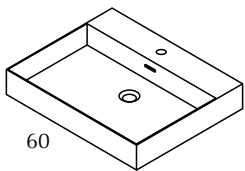

-GELCOAT basin with overflow.  
-Requires for installation valve SAP 100200010, 72 P.  
-Lavabo GELCOAT con troppopieno.  
-Richiede valvola SAP 100200010, 72 P.  
-Раковина GELCOAT с переливом.  
-Требуется установка клапана SAP 100200010, 72 P.

MEASURES	(xx)	FINISHES	SAP	POINTS
60x10x49	/ 23 <sup>5/8</sup> x3 <sup>7/8</sup> x19 <sup>1/4</sup>	GELCOAT	100221199	596
90x10x49	/ 35 <sup>3/8</sup> x3 <sup>7/8</sup> x19 <sup>1/4</sup>		100221203	765
120x10x49	/ 47 <sup>1/4</sup> x3 <sup>7/8</sup> x19 <sup>1/4</sup>		100221205	822
① FIXINGS / ANCLAJE PARED. 60/80/90/100 (1UND.) - 120 (2UNDS.)			250010391	9

## BASIN

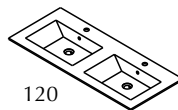
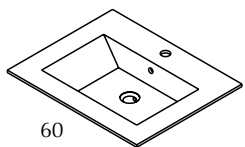

-GELCOAT basin with overflow.  
-Requires for installation valve SAP 100200010, 72 P.  
-Lavabo GELCOAT con troppopieno.  
-Richiede valvola SAP 100200010, 72 P.  
-Раковина GELCOAT с переливом.  
-Требуется установка клапана SAP 100200010, 72 P.

MEASURES	(xx)	FINISHES	SAP	POINTS
60,5x14,1x49,2	/ 23 <sup>7/8</sup> x5 <sup>1/2</sup> x19 <sup>3/8</sup>	GELCOAT	100160956	0560
120,5x14,1x49,2	/ 47 <sup>1/2</sup> x5 <sup>1/2</sup> x19 <sup>3/8</sup>		100171860	0981

## WORKTOP KRION STONE

DEPTH 49,2CM / 19<sup>3/8</sup>"

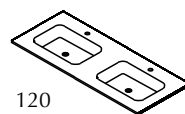
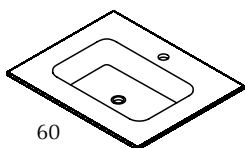

-Worktop KRION STONE with integrated basin.  
-Requires for installation permanent valve SAP 100036254.  
-Requires drainage SAP 100036255.  
-Top in KRION STONE con lavabo integrato.  
-Richiede valvola SAP 100036254.  
-Richiede scarico SAP 100036255.  
-Столешница KRION STONE со встроенной раковиной.  
-Требуется установка постоянного клапана SAP 100036254.  
-Требуется дренаж SAP 100036255.

MEASURES	(xx)	FINISHES	SAP	POINTS
60,2x13x49,2	/ 23 <sup>5/8</sup> x5 <sup>1/8</sup> x19 <sup>3/8</sup>	Krion STONE	100091017	617
120,2x13x49,2	/ 47 <sup>3/8</sup> x5 <sup>1/8</sup> x19 <sup>3/8</sup>		100110448	1356



The interpretation made in inches for the dimensions of the different items shown in the price list has been rounded to 1/8, however for a more accurate measurement please use millimetres or centimetres.

## Skill

<b>EXTERIOR FINISHES</b> FINITURE ESTERNE ОТДЕЛКА ДЛЯ НАРУЖНОГО ИСПОЛЬЗОВАНИЯ	<input type="checkbox"/> Laminate Laminato ЛАМИНАТ	<input type="checkbox"/> Matt lacquer Laccato opaco МАТОВЫЙ ЛАК	<input type="checkbox"/> Wood veneer Legno ДЕРЕВО
	<input type="checkbox"/> HPL Stratificato СЛОИСТАЯ	<input checked="" type="checkbox"/> Gloss lacquer Laccato lucido ГЛЯНЦЕВЫЙ ЛАК	
<b>INTERIOR FINISHES</b> FINITURE INTERNE ОТДЕЛКА ДЛЯ ВНУТРЕННЕГО ИСПОЛЬЗОВАНИЯ	<input checked="" type="checkbox"/> Laminate Laminato ЛАМИНАТ	<input type="checkbox"/> Wood veneer Legno ДЕРЕВО	<input type="checkbox"/> Aluminium+laminated base Alluminio + base in laminato Алюминий + основа из ламината
	<input type="checkbox"/> Front handle Maniglia frontale a vista Декоративная передняя ручка	<input type="checkbox"/> Integrated metal handle Maniglia metallica integrata Встроенная металлическая ручка	<input checked="" type="checkbox"/> Integrated mechanized h. Maniglia integrata ricavata sul bordo Встроенная ручка по краю
<b>HANDLES</b> MANIGLIE РУЧКИ	<input type="checkbox"/> Push handle Maniglia Push РУЧКИ Push		
<b>TYPE OF UNITS</b> TIPI DI MODULI ТИПЫ МОДУЛЕЙ	<input checked="" type="checkbox"/> Compact Compatto Компактная	<input type="checkbox"/> Modular Modulare Модульная	
<b>POSITION</b> POSIZIONE ПОЗИЦИЯ	<input checked="" type="checkbox"/> Wall-mounted Sospeso Подвесная	<input type="checkbox"/> Floor-mounted A terra Напольная	
<b>MEASURES (CM)</b> DIMENSIONI РАЗМЕРЫ	◀ 60 / 90 / 120	▲ 42	▶ 48,5
	◀ 23 <sup>5/8</sup> / 35 <sup>3/8</sup> / 47 <sup>1/4</sup>	▲ 16 <sup>1/2</sup>	▶ 19 <sup>1/8</sup>
<b>WORKTOP &amp; BASIN OPTIONS</b> OPZIONI TOP E LAVABI ВАРИАНТЫ СТОЛЕШНИЦ И УМЫВАЛЬНЫХ РАКОВИН	<input type="checkbox"/> Bath serie's worktop / basin Lavabo / top della serie Серийная умывальная раковина / столешница	<input type="checkbox"/> Standard worktops Top standard Стандартные столешницы	<input checked="" type="checkbox"/> Worktop + integrated basin Encimera + lavabo integrato Столешница + встроенная умывальная раковина
	<input type="checkbox"/> Over-mounted basin Lavabo da appoggio Настольная умывальная раковина	<input type="checkbox"/> Under-mounted basin Lavabo sottopiano Умывальная раковина, встраиваемая в столешницу снизу	<input type="checkbox"/> Double basin as option Opzione doppia vasca Вариант с двойной чашей
<b>WORKTOP FINISHES</b> FINITURE TOP ОТДЕЛКА СТОЛЕШНИЦ	<input type="checkbox"/> Krion® worktop Top in KRION® Столешница KRION®	<input checked="" type="checkbox"/> Gel Coat worktop Top in Gel Coat Столешница с покрытием гелькоут	<input type="checkbox"/> Natural Stone worktop Top in pietra naturale Столешница из натурального камня.
	<input type="checkbox"/> Glass worktop Top in vetro Столешница из стекла	<input type="checkbox"/> Bath furniture finish worktop Top con la finitura del mobile Столешница с той же отделкой, что и консоль/тумба	
<b>BASIN FINISHES</b> FINITURE LAVABI ОТДЕЛКА УМЫВАЛЬНЫХ РАКОВИН	<input type="checkbox"/> Krion® basin Lavabo in Krion® Умывальная раковина из Krion®	<input checked="" type="checkbox"/> Gel Coat basin Lavabo Gelcoat Раковина Gelcoat	<input type="checkbox"/> Ceramic basin Lavabo in ceramica Керамическая умывальная раковина
	<input type="checkbox"/> Natural Stone basin Lavabo in pietra naturale Умывальная раковина из натурального камня.		
<b>ACCESSORIES</b> ACCESSORI АКСЕССУАРЫ	<input checked="" type="checkbox"/> Mirror Specchio Зеркало	<input type="checkbox"/> Wall-mounted module Modulo sospeso Подвесной модуль	<input type="checkbox"/> Tall cabinet Modulo colonna Высокий шкаф
	<input type="checkbox"/> Upper unit Modulo alto Верхний модуль	<input type="checkbox"/> Organizer Organizzatore Органайзер	<input type="checkbox"/> Shelves Mensola Полка
			<input type="checkbox"/> Accessories Accessori Аксессуары

# Skill



Skill is the beauty of simplicity made into bathroom furniture; this unit is characterized by a built-in side handle and a perfect organizing tray to gain storage in the bathroom. Skill is available in gloss lacquer, white and slate, a piece that becomes the star of the room.

Skill rappresenta la bellezza della semplicità. Questo mobile da bagno è caratterizzato da maniglia laterale integrata e da un vassoio organizzatore perfetto per sfruttare al meglio gli spazio all'interno del proprio bagno. Skill è disponibile in laccato lucido, nei colori bianco e ardesia, le sue caratteristiche lo rendono immediatamente protagonista all'interno del bagno.

Skill - это красота простоты, воплощенная в мебели для ванных комнат. Характеризуется встроенной боковой ручкой и идеальным лотком для оптимального хранения в ванной комнате. Skill доступно в глянцевоом лаке, белом и сланце. Мебель, которая становится звездой комнаты.



+info p.391





1952 Points  
SKILL Blanco Brillo

## FINISHES

GLOSS LACQUER

LACCATO LUCIDO

ГЛЯНЦЕВЫЙ ЛАК

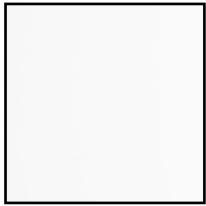

Blanco Emotions



Pizarra

## WASH BASIN UNIT BPS

DEPTH 48,5CM / 19 1/8"

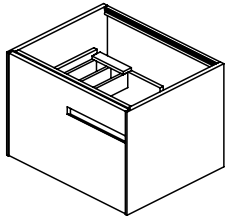

Wash basin unit. Organisation tray included.

Basi portalavabo. Include vassoio organizzatore.

Тумбочка под умывальник. Включает органайзер.

MEASURES	(x)x(x)x(x)	FINISHES	SAP	POINTS
60x42x48,5 / 23 <sup>5/8</sup> x16 <sup>1/2</sup> x19 <sup>1/8</sup>		Blanco Brillo	100242157	958
		Pizarra Brillo	100242172	
90x42x48,5 / 35 <sup>3/8</sup> x16 <sup>1/2</sup> x19 <sup>1/8</sup>		Blanco Brillo	100242180	1101
		Pizarra Brillo	100242164	
120x42x48,5 / 47 <sup>1/4</sup> x16 <sup>1/2</sup> x19 <sup>1/8</sup>		Blanco Brillo	100242190	1291
		Pizarra Brillo	100242165	

BP

## MIRROR SKILL

DEPTH 2CM / 0 3/4"

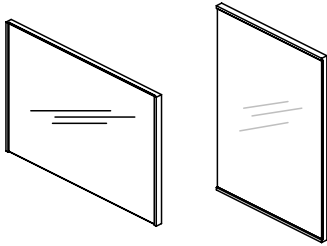

Mirror.

Specchio

Зеркало.

MEASURES	(x)x(x)x(x)	FINISHES	SAP	POINTS
60x42x2 / 23 <sup>5/8</sup> x16 <sup>1/2</sup> x0 <sup>3/4</sup>		Blanco Brillo	100242210	204
		Pizarra Brillo	100242179	
90x42x2 / 35 <sup>3/8</sup> x16 <sup>1/2</sup> x0 <sup>3/4</sup>		Blanco Brillo	100242182	231
		Pizarra Brillo	100242174	
120x42x2 / 47 <sup>1/4</sup> x16 <sup>1/2</sup> x0 <sup>3/4</sup>		Blanco Brillo	100242158	294
		Pizarra Brillo	100242173	

ES

## NEW DESS BASIN

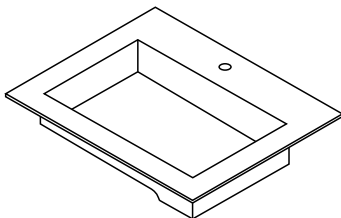

-GELCOAT basin.

-Requires for installation permanent valve SAP 100104178, 59 P.

-Requires drainage SAP 100036255, 103 P.

-Lavabo GELCOAT.

-Richiede valvola SAP 100104178, 59 P.

-Richiede scarico SAP 100036255, 103 P.

-Раковина GELCOAT.

-Требуется установка постоянного клапана SAP 100104178, 59 P.

-Требуется дренаж SAP 100036255, 103 P.

MEASURES	(x)x(x)x(x)	FINISHES	SAP	POINTS
60,2x13,2x48,5 / 23 <sup>3/4</sup> x5 <sup>1/4</sup> x19 <sup>1/8</sup>		GELCOAT / SG	100221192	469
		GELCOAT / 1G	100221191	
90,2x13,2x48,5 / 35 <sup>1/2</sup> x5 <sup>1/4</sup> x19 <sup>1/8</sup>		GELCOAT / SG	100221194	561
		GELCOAT / 1G	100221193	
120,2x13,2x48,5 / 47 <sup>3/8</sup> x5 <sup>1/4</sup> x19 <sup>1/8</sup>		GELCOAT / SG	100221196	675
		GELCOAT / 1G	100221195	

LA



The interpretation made in inches for the dimensions of the different items shown in the price list has been rounded to 1/8, however for a more accurate measurement please use millimetres or centimetres.

## Hem

<b>EXTERIOR FINISHES</b> FINITURE ESTERNE ОТДЕЛКА ДЛЯ НАРУЖНОГО ИСПОЛЬЗОВАНИЯ	<input checked="" type="checkbox"/> Laminate Laminato ЛАМИНАТ	<input type="checkbox"/> Matt lacquer Laccato opaco МАТОВЫЙ ЛАК	<input type="checkbox"/> Wood veneer Legno ДЕРЕВО
	<input type="checkbox"/> HPL Stratificato СЛОИСТАЯ	<input type="checkbox"/> Gloss lacquer Laccato lucido ГЛЯНЦЕВЫЙ ЛАК	
<b>INTERIOR FINISHES</b> FINITURE INTERNE ОТДЕЛКА ДЛЯ ВНУТРЕННЕГО ИСПОЛЬЗОВАНИЯ	<input checked="" type="checkbox"/> Laminate Laminato ЛАМИНАТ	<input type="checkbox"/> Wood veneer Legno ДЕРЕВО	<input type="checkbox"/> Aluminium+laminated base Alluminio + base in laminato Алюминий + основа из ламината
<b>HANDLES</b> MANIGLIE РУЧКИ	<input checked="" type="checkbox"/> Front handle Maniglia frontale a vista Декоративная передняя ручка	<input type="checkbox"/> Integrated metal handle Maniglia metallica integrata Встроенная металлическая ручка	<input type="checkbox"/> Integrated mechanized h. Maniglia integrata ricavata sul bordo Встроенная ручка по краю
	<input type="checkbox"/> Push handle Maniglia Push РУЧКИ Push		
<b>TYPE OF UNITS</b> TIPI DI MODULI ТИПЫ МОДУЛЕЙ	<input checked="" type="checkbox"/> Compact Compatto Компактная	<input type="checkbox"/> Modular Modulare Модульная	
<b>POSITION</b> POSIZIONE ПОЗИЦИЯ	<input checked="" type="checkbox"/> Wall-mounted Sospeso Подвесная	<input type="checkbox"/> Floor-mounted A terra Напольная	
<b>MEASURES (CM)</b> DIMENSIONI РАЗМЕРЫ	◀ 60 / 80 / 120 23 <sup>5/8</sup> / 31 <sup>1/2</sup> / 47 <sup>1/4</sup>	▲ 42 16 <sup>1/2</sup>	↙ 49 19 <sup>1/4</sup>
<b>WORKTOP &amp; BASIN OPTIONS</b> OPZIONI TOP E LAVABI ВАРИАНТЫ СТОЛЕШНИЦ И УМЫВАЛЬНЫХ РАКОВИН	<input type="checkbox"/> Bath serie's worktop / basin Lavabo / top della serie Серийная умывальная раковина / столешница	<input type="checkbox"/> Standard worktops Top standard Стандартные столешницы	<input checked="" type="checkbox"/> Worktop + integrated basin Encimera + lavabo integrato Столешница + встроенная умывальная раковина
	<input checked="" type="checkbox"/> Over-mounted basin Lavabo da appoggio Настольная умывальная раковина	<input type="checkbox"/> Under-mounted basin Lavabo sottopiano Умывальная раковина, встраиваемая в столешницу снизу	<input type="checkbox"/> Double basin as option Opzione doppia vasca Вариант с двойной чашей
<b>WORKTOP FINISHES</b> FINITURE TOP ОТДЕЛКА СТОЛЕШНИЦ	<input type="checkbox"/> Krion® worktop Top in KRION® Столешница KRION®	<input checked="" type="checkbox"/> Gel Coat worktop Top in Gel Coat Столешница с покрытием гелькоут	<input type="checkbox"/> Natural Stone worktop Top in pietra naturale Столешница из натурального камня.
	<input type="checkbox"/> Glass worktop Top in vetro Столешница из стекла	<input type="checkbox"/> Bath furniture finish worktop Top con la finitura del mobile Столешница с той же отделкой, что и консоль/тумба	
<b>BASIN FINISHES</b> FINITURE LAVABI ОТДЕЛКА УМЫВАЛЬНЫХ РАКОВИН	<input type="checkbox"/> Krion® basin Lavabo in Krion® Умывальная раковина из Krion®	<input checked="" type="checkbox"/> Gel Coat basin Lavabo Gelcoat Раковина Gelcoat	<input type="checkbox"/> Ceramic basin Lavabo in ceramica Керамическая умывальная раковина
	<input type="checkbox"/> Natural Stone basin Lavabo in pietra naturale Умывальная раковина из натурального камня.		
<b>ACCESSORIES</b> ACCESSORI АКСЕССУАРЫ	<input checked="" type="checkbox"/> Mirror Specchio Зеркало	<input checked="" type="checkbox"/> Wall-mounted module Modulo sospeso Подвесной модуль	<input checked="" type="checkbox"/> Tall cabinet Modulo colonna Высокий шкаф
	<input type="checkbox"/> Upper unit Modulo alto Верхний модуль	<input type="checkbox"/> Organizer Organizzatore Органайзер	<input type="checkbox"/> Shelves Mensola Полка
			<input type="checkbox"/> Accessories Accessori Аксессуары

# hem



hem

It is a very versatile bathroom cabinet with a large capacity drawer, which has a removable tray that allows us to keep order in our bathroom. It is characterized above all by very thin fronts, which provide a touch of style and distinction, in addition to two totally different finishes such as White and Sugi Black, both very attractive and elegant, perfect to be the centrepiece of any bathroom.

È un mobile da bagno molto versatile e con un cassetto di grande capacità. Il vassoio estraibile al suo interno ci permette di mantenere l'ordine nel nostro bagno. Il suo punto di forza sono le linee raffinate, che gli conferiscono un tocco di stile ed eleganza, oltre alle due finiture Blanco e Sugi Black, attraenti ed eleganti, perfette per essere il punto focale di ogni bagno.

Это очень универсальный шкаф для ванной комнаты с выдвижным ящиком большой емкости, с выдвижным поддоном, который позволяет нам поддерживать порядок в нашей ванной комнате. Отличительной особенностью являются тонкие фасады, которые несут в себе изящный стиль и не похожи на другие, в дополнение к двум совершенно разным видам отделки, таким как Blanco и Sugi Black, оба очень привлекательны и элегантны, идеально подходящие для того, чтобы быть центральным элементом любой ванной комнаты.



+



+



+info p.391

2399 Points  
HEM Sugi Black



hem



+info p.392

**2608 Points**  
**HEM Sugi Black**

## FINISHES

LAMINATE

LAMINATO

ЛАМИНАТ



Blanco



Sugi Black



## WASH BASIN UNIT BPS

DEPTH 49CM / 19 1/4"

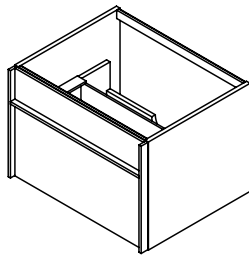

Wash basin unit. Organisation tray included.

Basi portalavabo. Include vassoio organizzatore.

Тумбочка под умывальник. Включает органайзер.



MEASURES (x x x)	FINISHES	SAP	POINTS
60x43x49 / 23 5/8 x 16 7/8 x 19 1/4	Blanco	100243626	0900
80x43x49 / 31 1/2 x 16 7/8 x 19 1/4		100243612	0931
120x43x49 / 47 1/4 x 16 7/8 x 19 1/4		100243607	1220
60x43x49 / 23 5/8 x 16 7/8 x 19 1/4	Sugi Black	100243584	0900
80x43x49 / 31 1/2 x 16 7/8 x 19 1/4		100243613	0931
120x43x49 / 47 1/4 x 16 7/8 x 19 1/4		100243618	1220

BP

## MIRROR

DEPTH 4CM / 1 5/8"

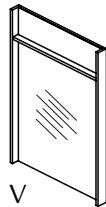
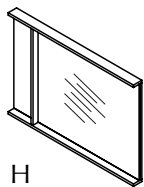

Mirror.

Specchio

Зеркало.

MEASURES (x x x)	FINISHES	SAP	POINTS
60x42x4 / 23 5/8 x 16 1/2 x 1 5/8	Blanco	100243615	0319
80x42x4 / 31 1/2 x 16 1/2 x 1 5/8		100243624	0343
120x42x4 / 47 1/4 x 16 1/2 x 1 5/8		100243597	0385
60x42x4 / 23 5/8 x 16 1/2 x 1 5/8	Sugi Black	100243622	0319
80x42x4 / 31 1/2 x 16 1/2 x 1 5/8		100243598	0343
120x42x4 / 47 1/4 x 16 1/2 x 1 5/8		100243577	0385

ES

## TALL CABINET

DEPTH 30CM / 11<sup>3/4</sup>"

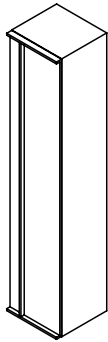

DX / SX

- Tall cabinet. DX / SX
- Modulo colonna. DX / SX
- Высокий шкаф. DX / SX

MC

MEASURES	FINISHES	SAP	POINTS
30x144x30 / 11 <sup>3/4</sup> x56 <sup>3/4</sup> x11 <sup>3/4</sup>	Blanco	100243585	0938
	Sugi Black	100243620	0938

## SLIM BASIN

DEPTH 49CM / 19<sup>1/4</sup>"

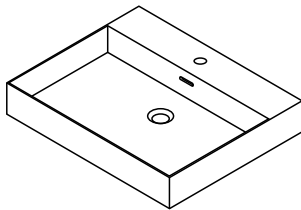

- GELCOAT basin with overflow.
- Requires for installation valve SAP 100200010, 72 P.
- Lavabo GELCOAT con troppopieno.
- Richiede valvola SAP 100200010, 72 P.
- Раковина GELCOAT с переливом.
- Требуется установка клапана SAP 100200010, 72 P.

MEASURES	FINISHES	SAP	POINTS
60x10x49 / 23 <sup>5/8</sup> x3 <sup>7/8</sup> x19 <sup>1/4</sup>	GELCOAT	100221199	596
80x10x49 / 31 <sup>1/2</sup> x3 <sup>7/8</sup> x19 <sup>1/4</sup>		100221201	682
120x10x49 / 47 <sup>1/4</sup> x3 <sup>7/8</sup> x19 <sup>1/4</sup>		100221205	822

## FIT BASIN

DEPTH 49CM / 19<sup>1/4</sup>"

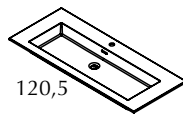
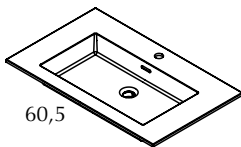

- GELCOAT basin with overflow.
- Requires for installation valve SAP 100200010, 72 P.
- Lavabo GELCOAT con troppopieno.
- Richiede valvola SAP 100200010, 72 P.
- Раковина GELCOAT с переливом.
- Требуется установка клапана SAP 100200010, 72 P.

MEASURES	FINISHES	SAP	POINTS
60,5x13,5x49 / 23 <sup>7/8</sup> x5 <sup>3/8</sup> x19 <sup>1/4</sup>	GELCOAT	100241712	427
80,5x13,5x49 / 31 <sup>3/4</sup> x5 <sup>3/8</sup> x19 <sup>1/4</sup>		100241723	532
120,5x13,5x49 / 47 <sup>1/2</sup> x5 <sup>3/8</sup> x19 <sup>1/4</sup>		100241693	794

## WORKTOP KRION STONE

DEPTH 49,2CM / 19<sup>3/8</sup>"

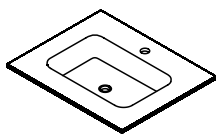

- Worktop KRION STONE with integrated basin.
- Requires for installation permanent valve SAP 100036254, 68 P.
- Top in KRION STONE con lavabo integrato.
- Richiede valvola SAP 100036254, 68 P.
- Столешница KRION STONE со встроенной раковиной.
- Требуется установка постоянного клапана SAP 100036254, 68 P.

MEASURES	FINISHES	SAP	POINTS
60,2x13x49,2 / 23 <sup>5/8</sup> x5 <sup>1/8</sup> x19 <sup>3/8</sup>	Krion STONE	100091017	617

LA

# skyline

hem



The interpretation made in inches for the dimensions of the different items shown in the price list has been rounded to 1/8, however for a more accurate measurement please use millimetres or centimetres.

## Tuck

<b>EXTERIOR FINISHES</b> FINITURE ESTERNE ОТДЕЛКА ДЛЯ НАРУЖНОГО ИСПОЛЬЗОВАНИЯ	<input checked="" type="checkbox"/> Laminate Laminato ЛАМИНАТ	<input type="checkbox"/> Matt lacquer Laccato opaco МАТОВЫЙ ЛАК	<input type="checkbox"/> Wood veneer Legno ДЕРЕВО
	<input type="checkbox"/> HPL Stratificato СЛОИСТАЯ	<input type="checkbox"/> Gloss lacquer Laccato lucido ГЛЯНЦЕВЫЙ ЛАК	
<b>INTERIOR FINISHES</b> FINITURE INTERNE ОТДЕЛКА ДЛЯ ВНУТРЕННЕГО ИСПОЛЬЗОВАНИЯ	<input checked="" type="checkbox"/> Laminate Laminato ЛАМИНАТ	<input type="checkbox"/> Wood veneer Legno ДЕРЕВО	<input type="checkbox"/> Aluminium+laminated base Alluminio + base in laminato Алюминий + основа из ламината
<b>HANDLES</b> MANIGLIE РУЧКИ	<input type="checkbox"/> Front handle Maniglia frontale a vista Декоративная передняя ручка	<input type="checkbox"/> Integrated metal handle Maniglia metallica integrata Встроенная металлическая ручка	<input checked="" type="checkbox"/> Integrated mechanized h. Maniglia integrata ricavata sul bordo Встроенная ручка по краю
	<input type="checkbox"/> Push handle Maniglia Push РУЧКИ Push		
<b>TYPE OF UNITS</b> TIPI DI MODULI ТИПЫ МОДУЛЕЙ	<input checked="" type="checkbox"/> Compact Compatto Компактная	<input type="checkbox"/> Modular Modulare Модульная	
<b>POSITION</b> POSIZIONE ПОЗИЦИЯ	<input checked="" type="checkbox"/> Wall-mounted Sospeso Подвесная	<input type="checkbox"/> Floor-mounted A terra Напольная	
<b>MEASURES (CM)</b> DIMENSIONI РАЗМЕРЫ	◀ 60 / 80 / 120 23 <sup>5/8</sup> / 31 <sup>1/2</sup> / 47 <sup>1/4</sup>	▲ 60 23 <sup>5/8</sup>	↘ 48 18 <sup>7/8</sup>
<b>WORKTOP &amp; BASIN OPTIONS</b> OPZIONI TOP E LAVABI ВАРИАНТЫ СТОЛЕШНИЦ И УМЫВАЛЬНЫХ РАКОВИН	<input type="checkbox"/> Bath serie's worktop / basin Lavabo / top della serie Серийная умывальная раковина / столешница	<input type="checkbox"/> Standard worktops Top standard Стандартные столешницы	<input checked="" type="checkbox"/> Worktop + integrated basin Encimera + lavabo integrato Столешница + встроенная умывальная раковина
	<input checked="" type="checkbox"/> Over-mounted basin Lavabo da appoggio Настольная умывальная раковина	<input type="checkbox"/> Under-mounted basin Lavabo sottopiano Умывальная раковина, встраиваемая в столешницу снизу	<input checked="" type="checkbox"/> Double basin as option Opzione doppia vasca Вариант с двойной чашей
<b>WORKTOP FINISHES</b> FINITURE TOP ОТДЕЛКА СТОЛЕШНИЦ	<input checked="" type="checkbox"/> Krion® worktop Top in KRION® Столешница KRION®	<input checked="" type="checkbox"/> Gel Coat worktop Top in Gel Coat Столешница с покрытием гелькоут	<input type="checkbox"/> Natural Stone worktop Top in pietra naturale Столешница из натурального камня.
	<input type="checkbox"/> Glass worktop Top in vetro Столешница из стекла	<input type="checkbox"/> Bath furniture finish worktop Top con la finitura del mobile Столешница с той же отделкой, что и консоль/тумба	
<b>BASIN FINISHES</b> FINITURE LAVABI ОТДЕЛКА УМЫВАЛЬНЫХ РАКОВИН	<input checked="" type="checkbox"/> Krion® basin Lavabo in Krion® Умывальная раковина из Krion®	<input checked="" type="checkbox"/> Gel Coat basin Lavabo Gelcoat Раковина Gelcoat	<input type="checkbox"/> Ceramic basin Lavabo in ceramica Керамическая умывальная раковина
	<input type="checkbox"/> Natural Stone basin Lavabo in pietra naturale Умывальная раковина из натурального камня.		
<b>ACCESSORIES</b> ACCESSORI АКСЕССУАРЫ	<input checked="" type="checkbox"/> Mirror Specchio Зеркало	<input type="checkbox"/> Wall-mounted module Modulo sospeso Подвесной модуль	<input type="checkbox"/> Tall cabinet Modulo colonna Высокий шкаф
	<input type="checkbox"/> Upper unit Modulo alto Верхний модуль	<input type="checkbox"/> Organizer Organizzatore Органайзер	<input type="checkbox"/> Shelves Mensola Полка
			<input type="checkbox"/> Accessories Accessori Аксессуары

# tuck



tuck

Tuck is a bathroom series made up of a washbasin unit featuring an individual or double drawer and vertical integrated handle, and a mirror whose special design includes an integrated shelf, made of the same material, and door so that objects can be stored inside it.

Serie da bagno formata da un modulo portalavabo con cassetto che può essere singolo o doppio, con maniglia verticale integrata e specchio dal design speciale con ripiano incorporato dello stesso materiale del mobile oppure munito di anta per riporre oggetti all'interno.

Эта серия для ванной комнаты включает модуль, в который устанавливается умывальная раковина, и ящик. Оба элемента могут быть выполнены в одинарном или двойном варианте. Модуль имеет вертикально встроенную ручку и зеркало с особым дизайном. В дополнение к этому — полка из того же материала или дверца, чтобы внутри можно было хранить разные предметы.



+info p.392



tuck



2963 Points  
TUCK Fresno Cendra

## FINISHES

LAMINATE

LAMINATO

ЛАМИНАТ



Fresno Cendra



Fresno Nigra



## WASH BASIN UNIT BPS

DEPTH 49CM / 19<sup>1</sup>/<sub>4</sub>"

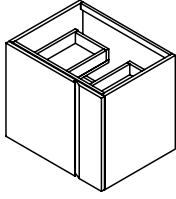

Wash basin unit.

Basi portalavabo

Тумбочка под умывальник.

MEASURES	()	FINISHES	SAP	POINTS
60x51x49 / 23 <sup>5</sup> / <sub>8</sub> x20 <sup>1</sup> / <sub>8</sub> x19 <sup>1</sup> / <sub>4</sub>		Fresno Cendra	100222331	1084
80x51x49 / 31 <sup>1</sup> / <sub>2</sub> x20 <sup>1</sup> / <sub>8</sub> x19 <sup>1</sup> / <sub>4</sub>			100222289	1129
120x51x49 / 47 <sup>1</sup> / <sub>4</sub> x20 <sup>1</sup> / <sub>8</sub> x19 <sup>1</sup> / <sub>4</sub>			100222278	1516
60x51x49 / 23 <sup>5</sup> / <sub>8</sub> x20 <sup>1</sup> / <sub>8</sub> x19 <sup>1</sup> / <sub>4</sub>		Fresno Nigra	100222288	1084
80x51x49 / 31 <sup>1</sup> / <sub>2</sub> x20 <sup>1</sup> / <sub>8</sub> x19 <sup>1</sup> / <sub>4</sub>			100222319	1129
120x51x49 / 47 <sup>1</sup> / <sub>4</sub> x20 <sup>1</sup> / <sub>8</sub> x19 <sup>1</sup> / <sub>4</sub>			100222330	1516

BP

## MIRROR

DEPTH 2CM / 0<sup>3</sup>/<sub>4</sub>"

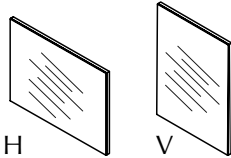

Mirror.

Specchio

Зеркало.

MEASURES	()	FINISHES	SAP	POINTS
56x45x2 / 22x17 <sup>3</sup> / <sub>4</sub> x0 <sup>3</sup> / <sub>4</sub>		Cuero	100222325	173
76x45x2 / 29 <sup>7</sup> / <sub>8</sub> x17 <sup>3</sup> / <sub>4</sub> x0 <sup>3</sup> / <sub>4</sub>			100222321	204
116x45x2 / 45 <sup>5</sup> / <sub>8</sub> x17 <sup>3</sup> / <sub>4</sub> x0 <sup>3</sup> / <sub>4</sub>			100222334	347

## MIRROR TUCK

DEPTH 13CM / 5<sup>1</sup>/<sub>8</sub>"

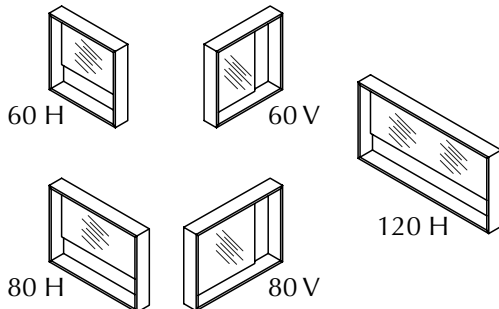

Mirror.

Specchio

Зеркало.

MEASURES	()	FINISHES	SAP	POINTS
60x60x13 / 23 <sup>5</sup> / <sub>8</sub> x23 <sup>5</sup> / <sub>8</sub> x5 <sup>1</sup> / <sub>8</sub>		Fresno Cendra V/H	100222324	447
		Fresno Nigra V/H	100222332	447
80x60x13 / 31 <sup>1</sup> / <sub>2</sub> x23 <sup>5</sup> / <sub>8</sub> x5 <sup>1</sup> / <sub>8</sub>		Fresno Cendra V/H	100241966	506
		Fresno Nigra V/H	100241989	506
120x60x13 / 47 <sup>1</sup> / <sub>4</sub> x23 <sup>5</sup> / <sub>8</sub> x5 <sup>1</sup> / <sub>8</sub>		Fresno Cendra H	100222294	553
		Fresno Nigra H	100222279	553

tuck

ES

## TALL CABINET

DEPTH 30CM / 11<sup>3/4</sup>"

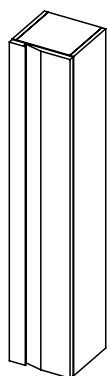

DX / SX

- Tall cabinet. DX / SX
- Modulo colonna. DX / SX
- Высокий шкаф. DX / SX

MC

MEASURES	( x  x )	FINISHES	SAP	POINTS
30x156x30	/ 11 <sup>3/4</sup> x61 <sup>3/8</sup> x11 <sup>3/4</sup>	Fresno Cendra	100242171	977
		Fresno Nigra	100242137	1010

## SLIM BASIN

DEPTH 49CM / 19<sup>1/4</sup>"

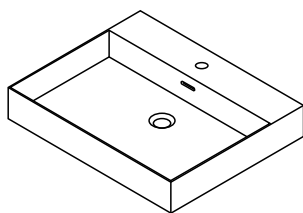

- GELCOAT basin with overflow.
- Requires for installation valve SAP 100200010, 72 P.
- Lavabo GELCOAT con troppopieno.
- Richiede valvola SAP 100200010, 72 P.
- Раковина GELCOAT с переливом.
- Требуется установка клапана SAP 100200010, 72 P.

MEASURES	( x  x )	FINISHES	SAP	POINTS
60x10x49	/ 23 <sup>5/8</sup> x3 <sup>7/8</sup> x19 <sup>1/4</sup>	GELCOAT	100221199	596
80x10x49	/ 31 <sup>1/2</sup> x3 <sup>7/8</sup> x19 <sup>1/4</sup>		100221201	682
120x10x49	/ 47 <sup>1/4</sup> x3 <sup>7/8</sup> x19 <sup>1/4</sup>		100221205	822

## BASIN

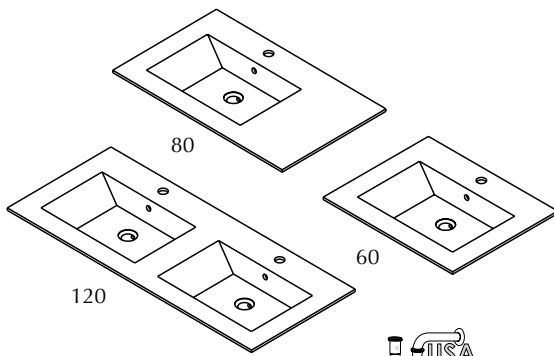

- GELCOAT basin with overflow.
- Requires for installation valve SAP 100200010, 72 P.
- Lavabo GELCOAT con troppopieno.
- Richiede valvola SAP 100200010, 72 P.
- Раковина GELCOAT с переливом.
- Требуется установка клапана SAP 100200010, 72 P.

MEASURES	(xx)	FINISHES	SAP	POINTS
60,5x14,1x49,2 / 23 <sup>7/8</sup> x5 <sup>1/2</sup> x19 <sup>3/8</sup>		GELCOAT	100160956	0560
80,5x14,1x49,2 / 31 <sup>3/4</sup> x5 <sup>1/2</sup> x19 <sup>3/8</sup>			100160957	0582
120,5x14,1x49,2 / 47 <sup>1/2</sup> x5 <sup>1/2</sup> x19 <sup>3/8</sup>			100171860	0981

## KRION STONE WORKTOP

DEPTH 49,2CM / 19<sup>3/8</sup>"

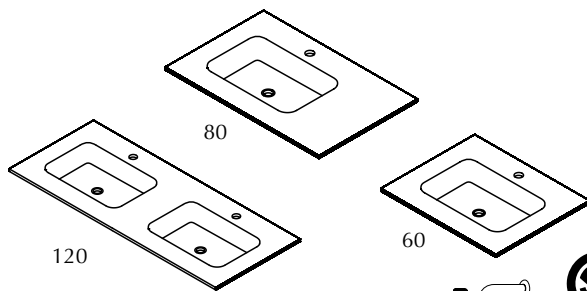

- KRION STONE Worktop with integrated basin.
- Requires for installation permanent valve SAP 100036254, 68 P.
- Requires drainage SAP 100036255, 103 P.
- Top in KRION STONE con lavabo integrato.
- Richiede valvola SAP 100036254, 68 P.
- Richiede scarico SAP 100036255, 103 P.
- Столешница KRION STONE со встроенной раковиной.
- Требуется установка постоянного клапана SAP 100036254, 68 P.
- Требуется дренаж SAP 100036255, 103 P.

MEASURES	(xx)	FINISHES	SAP	POINTS
60,2x13x49,2 / 23 <sup>5/8</sup> x5 <sup>1/8</sup> x19 <sup>3/8</sup>		Krión STONE	100091017	617
80,2x13x49,2 / 31 <sup>1/2</sup> x5 <sup>1/8</sup> x19 <sup>3/8</sup>			100091018	660
120,2x13x49,2 / 47 <sup>3/8</sup> x5 <sup>1/8</sup> x19 <sup>3/8</sup>			100110448	1356

## FIT BASIN

DEPTH 49CM / 19<sup>1/4</sup>"

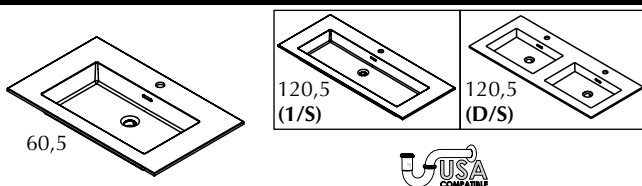

- GELCOAT basin with overflow.
- Requires for installation valve SAP 100200010, 72 P.
- Lavabo GELCOAT con troppopieno.
- Richiede valvola SAP 100200010, 72 P.
- Раковина GELCOAT с переливом.
- Требуется установка клапана SAP 100200010, 72 P.

MEASURES	(xx)	FINISHES	SAP	POINTS
60,5x13,5x49 / 23 <sup>7/8</sup> x5 <sup>3/8</sup> x19 <sup>1/4</sup>		GELCOAT	100241712	427
80,5x13,5x49 / 31 <sup>3/4</sup> x5 <sup>3/8</sup> x19 <sup>1/4</sup>			100241723	532
120,5x13,5x49 / 47 <sup>1/2</sup> x5 <sup>3/8</sup> x19 <sup>1/4</sup> (1/S)			100241693	794
120,5x13,5x49 / 47 <sup>1/2</sup> x5 <sup>3/8</sup> x19 <sup>1/4</sup> (D/S)			100296392	898



The interpretation made in inches for the dimensions of the different items shown in the price list has been rounded to 1/8, however for a more accurate measurement please use millimetres or centimetres.

## Nut

<b>EXTERIOR FINISHES</b> FINITURE ESTERNE ОТДЕЛКА ДЛЯ НАРУЖНОГО ИСПОЛЬЗОВАНИЯ	<input checked="" type="checkbox"/> Laminate Laminato ЛАМИНАТ	<input type="checkbox"/> Matt lacquer Laccato opaco МАТОВЫЙ ЛАК	<input type="checkbox"/> Wood veneer Legno ДЕРЕВО
	<input type="checkbox"/> HPL Stratificato СЛОИСТАЯ	<input type="checkbox"/> Gloss lacquer Laccato lucido ГЛЯНЦЕВЫЙ ЛАК	
<b>INTERIOR FINISHES</b> FINITURE INTERNE ОТДЕЛКА ДЛЯ ВНУТРЕННЕГО ИСПОЛЬЗОВАНИЯ	<input checked="" type="checkbox"/> Laminate Laminato ЛАМИНАТ	<input type="checkbox"/> Wood veneer Legno ДЕРЕВО	<input type="checkbox"/> Aluminium+laminated base Alluminio + base in laminato Алюминий + основа из ламината
	<input type="checkbox"/> Front handle Maniglia frontale a vista Декоративная передняя ручка	<input checked="" type="checkbox"/> Integrated metal handle Maniglia metallica integrata Встроенная металлическая ручка	<input type="checkbox"/> Integrated mechanized h. Maniglia integrata ricavata sul bordo Встроенная ручка по краю
<b>HANDLES</b> MANIGLIE РУЧКИ	<input type="checkbox"/> Push handle Maniglia Push РУЧКИ Push		
<b>TYPE OF UNITS</b> TIPI DI MODULI ТИПЫ МОДУЛЕЙ	<input checked="" type="checkbox"/> Compact Compatto Компактная	<input type="checkbox"/> Modular Modulare Модульная	
<b>POSITION</b> POSIZIONE ПОЗИЦИЯ	<input checked="" type="checkbox"/> Wall-mounted Sospeso Подвесная	<input type="checkbox"/> Floor-mounted A terra Напольная	
<b>MEASURES (CM)</b> DIMENSIONI РАЗМЕРЫ	◀ 49 19 <sup>1/4</sup>	▲ 50 19 <sup>5/8</sup>	↘ 38 15
<b>WORKTOP &amp; BASIN OPTIONS</b> OPZIONI TOP E LAVABI ВАРИАНТЫ СТОЛЕШНИЦ И УМЫВАЛЬНЫХ РАКОВИН	<input checked="" type="checkbox"/> Bath serie's worktop / basin Lavabo / top della serie Серийная умывальная раковина / столешница	<input type="checkbox"/> Standard worktops Top standard Стандартные столешницы	<input checked="" type="checkbox"/> Worktop + integrated basin Encimera + lavabo integrato Столешница + встроенная умывальная раковина
	<input type="checkbox"/> Over-mounted basin Lavabo da appoggio Настольная умывальная раковина	<input type="checkbox"/> Under-mounted basin Lavabo sottopiano Умывальная раковина, встраиваемая в столешницу снизу	<input type="checkbox"/> Double basin as option Opzione doppia vasca Вариант с двойной чашей
<b>WORKTOP FINISHES</b> FINITURE TOP ОТДЕЛКА СТОЛЕШНИЦ	<input type="checkbox"/> Krion® worktop Top in KRION® Столешница KRION®	<input checked="" type="checkbox"/> Gel Coat worktop Top in Gel Coat Столешница с покрытием гелькоут	<input type="checkbox"/> Natural Stone worktop Top in pietra naturale Столешница из натурального камня.
	<input type="checkbox"/> Glass worktop Top in vetro Столешница из стекла	<input type="checkbox"/> Bath furniture finish worktop Top con la finitura del mobile Столешница с той же отделкой, что и консоль/тумба	
<b>BASIN FINISHES</b> FINITURE LAVABI ОТДЕЛКА УМЫВАЛЬНЫХ РАКОВИН	<input type="checkbox"/> Krion® basin Lavabo in Krion® Умывальная раковина из Krion®	<input checked="" type="checkbox"/> Gel Coat basin Lavabo Gelcoat Раковина Gelcoat	<input type="checkbox"/> Ceramic basin Lavabo in ceramica Керамическая умывальная раковина
	<input type="checkbox"/> Natural Stone basin Lavabo in pietra naturale Умывальная раковина из натурального камня.		
<b>ACCESSORIES</b> ACCESSORI АКСЕССУАРЫ	<input checked="" type="checkbox"/> Mirror Specchio Зеркало	<input type="checkbox"/> Wall-mounted module Modulo sospeso Подвесной модуль	<input type="checkbox"/> Tall cabinet Modulo colonna Высокий шкаф
	<input type="checkbox"/> Upper unit Modulo alto Верхний модуль	<input type="checkbox"/> Organizer Organizzatore Органайзер	<input type="checkbox"/> Shelves Mensola Полка
			<input type="checkbox"/> Accessories Accessori Аксессуары

# *nut*



nut

Nut is a minimalist shallow bathroom unit, featuring a drawer with an integrated handle. Its washbasin is distinctive in design, with the tap on one side unlike other models. The outcome is an apparently simple bathroom unit conceived to lend bathrooms a highly original appearance, thanks to its design and special features.

Nut è un mobile da bagno minimalista e poco profondo che dispone di un cassetto con maniglia integrata. Il lavabo presenta un design speciale in cui il rubinetto, al contrario di altri modelli, è posizionato su un lato: così, con un pezzo semplice solo in apparenza, il bagno diventa diverso e speciale grazie ai dettagli dei materiali e al design.

Nut — это мебель для ванной комнаты, созданная в стиле минимализма. Она отличается небольшой глубиной, имеет один ящик и встроенную ручку. Умывальная раковина обладает особым дизайном: в отличие от других моделей, смеситель здесь расположен сбоку. Изделие, которое на первый взгляд могло бы показаться простым, делает ванную комнату необычной благодаря изысканным материалам и дизайну.



+info p.392



nut



1144 Points  
NUT Roble Carbón

## FINISHES

LAMINATE

LAMINATO

ЛАМИНАТ



Roble Carbón



## WASH BASIN UNIT BPS

DEPTH 38CM / 15"

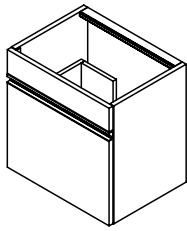

Wash basin unit.

Basi portalavabo

Тумбочка под умывальник.



MEASURES	(xx)	FINISHES	SAP	POINTS
49x50x38 / 19 <sup>1/4</sup> x19 <sup>5/8</sup> x15		Roble Carbón	100314883	511

BP

## MIRROR NUT

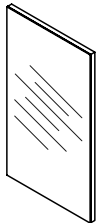
DEPTH 3CM / 1<sup>1/8</sup>"

Mirror.

Specchio

Зеркало.

MEASURES	(xx)	FINISHES	SAP	POINTS
40x70x3 / 15 <sup>3/4</sup> x27 <sup>1/2</sup> x1 <sup>1/8</sup>		Roble Carbón	100314857	236

ES

## GELCOAT BASIN

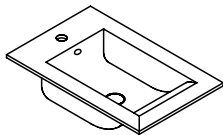

-GELCOAT basin with overflow.

**-Requires for installation valve SAP 100200010, 72 P.**

-Lavabo GELCOAT con troppopieno.

**-Richiede valvola SAP 100200010, 72 P.**

-Раковина GELCOAT с переливом.

-Требуется установка клапана SAP 100200010, 72 P.



MEASURES	(xx)	FINISHES	SAP	POINTS
50,4x13,2x38,2 / 19 <sup>7/8</sup> x5 <sup>1/4</sup> x15		GELCOAT	100144923	397

	FINISHES	SAP	POINTS
VALVE	Chrome	100200010	72

LA



The interpretation made in inches for the dimensions of the different items shown in the price list has been rounded to 1/8, however for a more accurate measurement please use millimetres or centimetres.

## Bambu

<b>EXTERIOR FINISHES</b> FINITURE ESTERNE ОТДЕЛКА ДЛЯ НАРУЖНОГО ИСПОЛЬЗОВАНИЯ	<input type="checkbox"/> Laminate Laminato ЛАМИНАТ	<input type="checkbox"/> Matt lacquer Laccato opaco МАТОВЫЙ ЛАК	<input type="checkbox"/> Wood veneer Legno ДЕРЕВО
	<input type="checkbox"/> HPL Stratificato СЛОИСТАЯ	<input checked="" type="checkbox"/> Gloss lacquer Laccato lucido ГЛЯНЦЕВЫЙ ЛАК	
<b>INTERIOR FINISHES</b> FINITURE INTERNE ОТДЕЛКА ДЛЯ ВНУТРЕННЕГО ИСПОЛЬЗОВАНИЯ	<input checked="" type="checkbox"/> Laminate Laminato ЛАМИНАТ	<input type="checkbox"/> Wood veneer Legno ДЕРЕВО	<input type="checkbox"/> Aluminium+laminated base Alluminio + base in laminato Алюминий + основа из ламината
	<input type="checkbox"/> Front handle Maniglia frontale a vista Декоративная передняя ручка	<input type="checkbox"/> Integrated metal handle Maniglia metallica integrata Встроенная металлическая ручка	<input checked="" type="checkbox"/> Integrated mechanized h. Maniglia integrata ricavata sul bordo Встроенная ручка по краю
<b>HANDLES</b> MANIGLIE РУЧКИ	<input type="checkbox"/> Push handle Maniglia Push РУЧКИ Push		
<b>TYPE OF UNITS</b> TIPI DI MODULI ТИПЫ МОДУЛЕЙ	<input checked="" type="checkbox"/> Compact Compatto Компактная	<input type="checkbox"/> Modular Modulare Модульная	
<b>POSITION</b> POSIZIONE ПОЗИЦИЯ	<input checked="" type="checkbox"/> Wall-mounted Sospeso Подвесная	<input type="checkbox"/> Floor-mounted A terra Напольная	
<b>MEASURES (CM)</b> DIMENSIONI РАЗМЕРЫ	60 / 80	48	46
	23 <sup>5/8</sup> / 31 <sup>1/2</sup>	18 <sup>7/8</sup>	18 <sup>1/8</sup>
<b>WORKTOP &amp; BASIN OPTIONS</b> OPZIONI TOP E LAVABI ВАРИАНТЫ СТОЛЕШНИЦ И УМЫВАЛЬНЫХ РАКОВИН	<input type="checkbox"/> Bath serie's worktop / basin Lavabo / top della serie Серийная умывальная раковина / столешница	<input type="checkbox"/> Standard worktops Top standard Стандартные столешницы	<input checked="" type="checkbox"/> Worktop + integrated basin Encimera + lavabo integrato Столешница + встроенная умывальная раковина
	<input type="checkbox"/> Over-mounted basin Lavabo da appoggio Настольная умывальная раковина	<input type="checkbox"/> Under-mounted basin Lavabo sotto Умывальная раковина, встраиваемая в столешницу снизу	<input type="checkbox"/> Double basin as option Opzione doppia vasca Вариант с двойной чашей
<b>WORKTOP FINISHES</b> FINITURE TOP ОТДЕЛКА СТОЛЕШНИЦ	<input type="checkbox"/> Krion® worktop Top in KRION® Столешница KRION®	<input checked="" type="checkbox"/> Gel Coat worktop Top in Gel Coat Столешница с покрытием гелькоут	<input type="checkbox"/> Natural Stone worktop Top in pietra naturale Столешница из натурального камня.
	<input checked="" type="checkbox"/> Glass worktop Top in vetro Столешница из стекла	<input type="checkbox"/> Bath furniture finish worktop Top con la finitura del mobile Столешница с той же отделкой, что и консоль/тумба	
<b>BASIN FINISHES</b> FINITURE LAVABI ОТДЕЛКА УМЫВАЛЬНЫХ РАКОВИН	<input type="checkbox"/> Krion® basin Lavabo in Krion® Умывальная раковина из Krion®	<input type="checkbox"/> Gel Coat basin Lavabo Gelcoat Раковина Gelcoat	<input type="checkbox"/> Ceramic basin Lavabo in ceramica Керамическая умывальная раковина
	<input type="checkbox"/> Natural Stone basin Lavabo in pietra naturale Умывальная раковина из натурального камня.		
<b>ACCESSORIES</b> ACCESSORI АКСЕССУАРЫ	<input checked="" type="checkbox"/> Mirror Specchio Зеркало	<input type="checkbox"/> Wall-mounted module Modulo sospeso Подвесной модуль	<input type="checkbox"/> Tall cabinet Modulo colonna Высокий шкаф
	<input type="checkbox"/> Upper unit Modulo alto Верхний модуль	<input checked="" type="checkbox"/> Organizer Organizzatore Органайзер	<input type="checkbox"/> Shelves Mensola Полка
			<input type="checkbox"/> Accessories Accessori Аксессуары

# *bambu*



bamboo

Wall suspended bathroom unit in a straight line design. Comes with two manual opening drawers and fits round the U-bend.

Mobile da bagno sospeso a parete dalle linee rette. Disponibile con due cassetti ad estrazione manuale e foro per sifone.

Подвесной блок для ванной комнаты, монтирующийся на стену, отличается четкостью прямых линий. Поставляется с двумя выдвижными ящиками, открываемыми вручную. Подходит для установки в место U-образного изгиба.



1852 Points  
**BAMBU blanco brillo**

+info p.392



bambu



+info p.393

1783 Points  
BAMBU gris sombra

## FINISHES

GLOSS LACQUER

LACCATO LUCIDO

ГЛЯНЦЕВЫЙ ЛАК

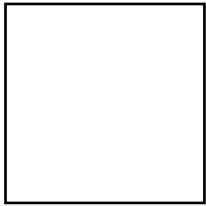

Blanco brillo



Gris sombra  
brillo

## WASH BASIN UNIT BPS 60

DEPTH 46CM / 18<sup>1</sup>/<sub>8</sub>"

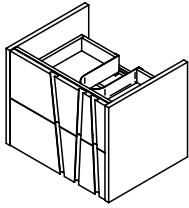

Wash basin unit.  
Basi portalavabo  
Тумбочка под умывальник.

MEASURES	(xx)	FINISHES	SAP	POINTS
60x48x46	/ 23 <sup>5</sup> / <sub>8</sub> x18 <sup>7</sup> / <sub>8</sub> x18 <sup>1</sup> / <sub>8</sub>	Blanco brillo	100208438	1005
		Gris sombra brillo	100208446	

## WASH BASIN UNIT BPS 80

DEPTH 46CM / 18<sup>1</sup>/<sub>8</sub>"

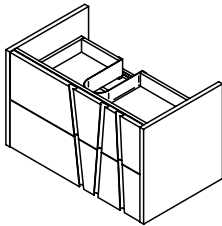

Wash basin unit.  
Basi portalavabo  
Тумбочка под умывальник.

MEASURES	(xx)	FINISHES	SAP	POINTS	BP
80,5x48x46	/ 31 <sup>3</sup> / <sub>4</sub> x18 <sup>7</sup> / <sub>8</sub> x18 <sup>1</sup> / <sub>8</sub>	Blanco brillo	100208467	1074	
		Gris sombra brillo	100208468		

## MIRROR BAMBU

DEPTH 2,1CM / 0<sup>7</sup>/<sub>8</sub>"

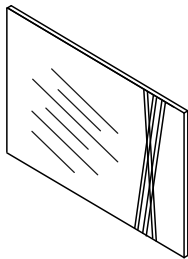

Mirror.  
Specchio  
Зеркало.

MEASURES	(xx)	SAP	POINTS
55x60x2,1	/ 21 <sup>5</sup> / <sub>8</sub> x23 <sup>5</sup> / <sub>8</sub> x0 <sup>7</sup> / <sub>8</sub>	100112922	143
75x60x2,1	/ 29 <sup>1</sup> / <sub>2</sub> x23 <sup>5</sup> / <sub>8</sub> x0 <sup>7</sup> / <sub>8</sub>	100112923	187

# bambu

## GLASS WORKTOP

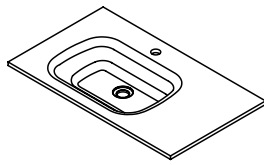

Glass worktop with incorporated basin.  
Requires for installation valve SAP 100200010, 72 P.

Top in vetro.  
Richiede valvola SAP 100200010, 72 P.

-Керамическая раковина.  
Требуется установка постоянного клапана SAP 100200010, 72 P.

MEASURES	FINISHES	SAP	POINTS
60,5x12x47 / 23 <sup>7/8</sup> x4 <sup>3/4</sup> x18 <sup>1/2</sup>	Cristal blanco brillo	100173921	704
	Cristal gris sombra brillo	100173888	
	Cristal negro brillo	100172879	
81x12x47 / 31 <sup>7/8</sup> x4 <sup>3/4</sup> x18 <sup>1/2</sup>	Cristal blanco brillo	100173908	815
	Cristal gris sombra brillo	100173922	
	Cristal negro brillo	100172912	

## WAY 60 BASIN

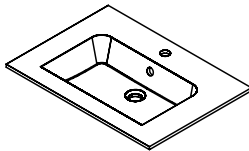

GELCOAT basin.  
Requires for installation valve SAP 100200010, 72 P.

Lavabo GELCOAT  
Richiede valvola SAP 100200010, 72 P.

Раковина GELCOAT.  
Требуется установка постоянного клапана SAP 100200010, 72 P.

MEASURES	FINISHES	SAP	POINTS
60x12x46 / 23 <sup>5/8</sup> x4 <sup>3/4</sup> x18 <sup>1/8</sup>	GELCOAT	100172893	491

## WAY 80 BASIN

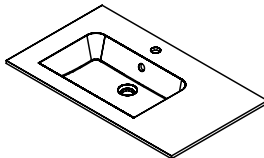

GELCOAT basin.  
Requires for installation valve SAP 100200010, 72 P.

Lavabo GELCOAT  
Richiede valvola SAP 100200010, 72 P.

Раковина GELCOAT.  
Требуется установка постоянного клапана SAP 100200010, 72 P.

MEASURES	FINISHES	SAP	POINTS
80x12x46 / 31 <sup>1/2</sup> x4 <sup>3/4</sup> x18 <sup>1/8</sup>	GELCOAT	100172916	522



# skyline

bambu



The interpretation made in inches for the dimensions of the different items shown in the price list has been rounded to 1/8, however for a more accurate measurement please use millimetres or centimetres.

## Urban

<b>EXTERIOR FINISHES</b> FINITURE ESTERNE ОТДЕЛКА ДЛЯ НАРУЖНОГО ИСПОЛЬЗОВАНИЯ	<input checked="" type="checkbox"/> Laminate Laminato ЛАМИНАТ	<input type="checkbox"/> Matt lacquer Laccato opaco МАТОВЫЙ ЛАК	<input type="checkbox"/> Wood veneer Legno ДЕРЕВО
	<input type="checkbox"/> HPL Stratificato СЛОИСТАЯ	<input type="checkbox"/> Gloss lacquer Laccato lucido ГЛЯНЦЕВЫЙ ЛАК	
<b>INTERIOR FINISHES</b> FINITURE INTERNE ОТДЕЛКА ДЛЯ ВНУТРЕННЕГО ИСПОЛЬЗОВАНИЯ	<input checked="" type="checkbox"/> Laminate Laminato ЛАМИНАТ	<input type="checkbox"/> Wood veneer Legno ДЕРЕВО	<input type="checkbox"/> Aluminium+laminated base Alluminio + base in laminato Алюминий + основа из ламината
<b>HANDLES</b> MANIGLIE РУЧКИ	<input checked="" type="checkbox"/> Front handle Maniglia frontale a vista Декоративная передняя ручка	<input type="checkbox"/> Integrated metal handle Maniglia metallica integrata Встроенная металлическая ручка	<input type="checkbox"/> Integrated mechanized h. Maniglia integrata ricavata sul bordo Встроенная ручка по краю
	<input type="checkbox"/> Push handle Maniglia Push РУЧКИ Push		
<b>TYPE OF UNITS</b> TIPI DI MODULI ТИПЫ МОДУЛЕЙ	<input checked="" type="checkbox"/> Compact Compatto Компактная	<input type="checkbox"/> Modular Modulare Модульная	
<b>POSITION</b> POSIZIONE ПОЗИЦИЯ	<input checked="" type="checkbox"/> Wall-mounted Sospeso Подвесная	<input type="checkbox"/> Floor-mounted A terra Напольная	
<b>MEASURES (CM)</b> DIMENSIONI РАЗМЕРЫ	60 / 80 / 120	48	48
	23 <sup>5/8</sup> / 31 <sup>1/2</sup> / 47 <sup>1/4</sup>	18 <sup>7/8</sup>	18 <sup>7/8</sup>
<b>WORKTOP &amp; BASIN OPTIONS</b> OPZIONI TOP E LAVABI ВАРИАНТЫ СТОЛЕШНИЦ И УМЫВАЛЬНЫХ РАКОВИН	<input type="checkbox"/> Bath serie's worktop / basin Lavabo / top della serie Серийная умывальная раковина / столешница	<input type="checkbox"/> Standard worktops Top standard Стандартные столешницы	<input checked="" type="checkbox"/> Worktop + integrated basin Encimera + lavabo integrato Столешница + встроенная умывальная раковина
	<input type="checkbox"/> Over-mounted basin Lavabo da appoggio Настольная умывальная раковина	<input type="checkbox"/> Under-mounted basin Lavabo sottopiano Умывальная раковина, встраиваемая в столешницу снизу	<input checked="" type="checkbox"/> Double basin as option Opzione doppia vasca Вариант с двойной чашей
<b>WORKTOP FINISHES</b> FINITURE TOP ОТДЕЛКА СТОЛЕШНИЦ	<input checked="" type="checkbox"/> Krion® worktop Top in KRION® Столешница KRION®	<input checked="" type="checkbox"/> Gel Coat worktop Top in Gel Coat Столешница с покрытием гелькоут	<input type="checkbox"/> Natural Stone worktop Top in pietra naturale Столешница из натурального камня.
	<input type="checkbox"/> Glass worktop Top in vetro Столешница из стекла	<input type="checkbox"/> Bath furniture finish worktop Top con la finitura del mobile Столешница с той же отделкой, что и консоль/тумба	
<b>BASIN FINISHES</b> FINITURE LAVABI ОТДЕЛКА УМЫВАЛЬНЫХ РАКОВИН	<input type="checkbox"/> Krion® basin Lavabo in Krion® Умывальная раковина из Krion®	<input type="checkbox"/> Gel Coat basin Lavabo Gelcoat Раковина Gelcoat	<input type="checkbox"/> Ceramic basin Lavabo in ceramica Керамическая умывальная раковина
	<input type="checkbox"/> Natural Stone basin Lavabo in pietra naturale Умывальная раковина из натурального камня.		
<b>ACCESSORIES</b> ACCESSORI АКСЕССУАРЫ	<input checked="" type="checkbox"/> Mirror Specchio Зеркало	<input type="checkbox"/> Wall-mounted module Modulo sospeso Подвесной модуль	<input type="checkbox"/> Tall cabinet Modulo colonna Высокий шкаф
	<input type="checkbox"/> Upper unit Modulo alto Верхний модуль	<input type="checkbox"/> Organizer Organizzatore Органайзер	<input type="checkbox"/> Shelves Mensola Полка
			<input checked="" type="checkbox"/> Accessories Accessori Аксессуары

# urban



Wall-hung bathroom cabinet with straight-line design and available in gloss white laminate and oak rood laminate. Equipped with a drawer pulled-out by hand with recessed handle and a space to clear the trap. The series includes mirror, Gelcoat basin, and support leg.

Mobile da bagno sospeso, dalle linee rette disponibile in laminato bianco lucido e rovere rood. Dispone di un cassetto ad estrazione manuale con maniglia incassata e foro per sifone. La serie dispone di specchio, lavabo in Gelcoat e piedini di appoggio.

Настенный шкаф для ванной комнаты отличается четкостью прямых линий. Предлагается в двух вариантах отделки: белым глянцевым ламинатом и ламинатом из древесины дуба. Оборудован выдвигаемым ящиком с утопленной ручкой. Предусмотрено пространство, позволяющее осуществлять чистку сифона. В эту серию входят зеркало, раковина Gelcoat и опорная ножка.



+



+



+info p.393

1332 Points  
**URBAN laminado roble root**



urban



+info p.393

**2376 Points**  
**URBAN laminado roble root**

## FINISHES

LAMINATE

LAMINATO

ЛАМИНАТ

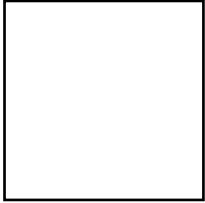

Blanco Brillo



Roble Root

## URBAN N WASH BASIN UNIT

DEPTH 48,2CM / 19"

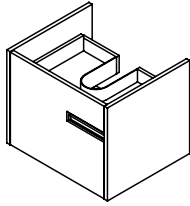

Wash basin unit.  
Basi portalavabo  
Тумбочка под умывальник.



MEASURES (WxDxH)	FINISHES	SAP	POINTS
60x48x48,2 / 23 <sup>5/8</sup> x18 <sup>7/8</sup> x19	Laminate Blanco Brillo	100304640	627
	Laminate Roble Root	100304638	
80x48x48,2 / 31 <sup>1/2</sup> x18 <sup>7/8</sup> x19	Laminate Blanco Brillo	100304643	724
	Laminate Roble Root	100304661	
120x48x48,2 / 47 <sup>1/4</sup> x18 <sup>7/8</sup> x19	Laminate Blanco Brillo	100304623	1091
	Laminate Roble Root	100304625	

BP

## BASIN

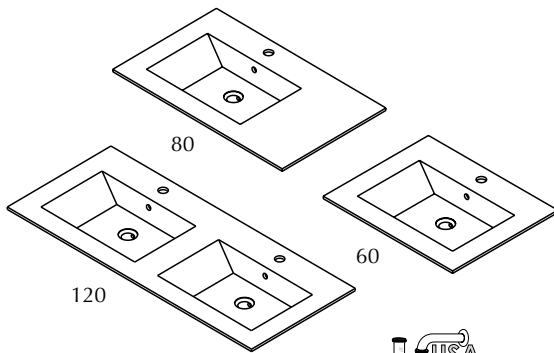

-GELCOAT basin with overflow.  
-Requires for installation valve SAP 100200010, 72 P.  
-Lavabo GELCOAT con troppopieno.  
-Richiede valvola SAP 100200010, 72 P.  
-Раковина GELCOAT с переливом.  
-Требуется установка клапана SAP 100200010, 72 P.



MEASURES (WxDxH)	FINISHES	SAP	POINTS
60,5x14,1x49,2 / 23 <sup>7/8</sup> x5 <sup>1/2</sup> x19 <sup>3/8</sup>	GELCOAT	100160956	0560
80,5x14,1x49,2 / 31 <sup>3/4</sup> x5 <sup>1/2</sup> x19 <sup>3/8</sup>		100160957	0582
120,5x14,1x49,2 / 47 <sup>1/2</sup> x5 <sup>1/2</sup> x19 <sup>3/8</sup>		100171860	0981

## KRION STONE WORKTOP

DEPTH 49,2CM / 19<sup>3/8</sup>"

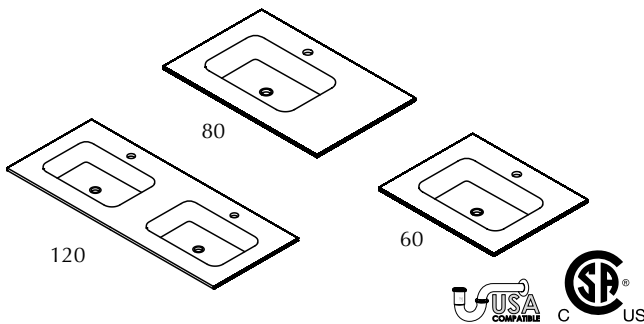

-KRION STONE Worktop with integrated basin.  
-Requires for installation permanent valve SAP 100036254, 68 P.  
-Requires drainage SAP 100036255, 103 P.  
-Top in KRION STONE con lavabo integrato.  
-Richiede valvola SAP 100036254, 68 P.  
-Richiede scarico SAP 100036255, 103 P.  
-Столешница KRION STONE со встроенной раковиной.  
-Требуется установка постоянного клапана SAP 100036254, 68 P.  
-Требуется дренаж SAP 100036255, 103 P.



MEASURES (WxDxH)	FINISHES	SAP	POINTS
60,2x13x49,2 / 23 <sup>5/8</sup> x5 <sup>1/8</sup> x19 <sup>3/8</sup>	Krion STONE	100091017	617
80,2x13x49,2 / 31 <sup>1/2</sup> x5 <sup>1/8</sup> x19 <sup>3/8</sup>		100091018	660
120,2x13x49,2 / 47 <sup>3/8</sup> x5 <sup>1/8</sup> x19 <sup>3/8</sup>		100110448	1356

LA

# urban

## SLIM BASIN

DEPTH 49CM / 19<sup>1</sup>/<sub>4</sub>"

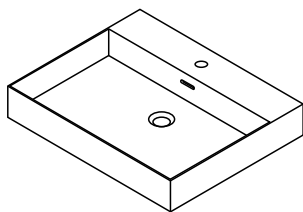

- GELCOAT basin with overflow.
- Requires for installation valve SAP 100200010, 72 P.
- Lavabo GELCOAT con troppopieno.
- Richiede valvola SAP 100200010, 72 P.
- Раковина GELCOAT с переливом.
- Требуется установка клапана SAP 100200010, 72 P.



MEASURES	FINISHES	SAP	POINTS
60x10x49 / 23 <sup>5</sup> / <sub>8</sub> x3 <sup>7</sup> / <sub>8</sub> x19 <sup>1</sup> / <sub>4</sub>	GELCOAT	100221199	596

## FIT BASIN

DEPTH 49CM / 19<sup>1</sup>/<sub>4</sub>"

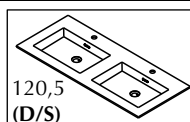
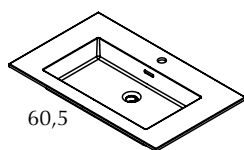

- GELCOAT basin with overflow.
- Requires for installation valve SAP 100200010, 72 P.
- Lavabo GELCOAT con troppopieno.
- Richiede valvola SAP 100200010, 72 P.
- Раковина GELCOAT с переливом.
- Требуется установка клапана SAP 100200010, 72 P.



MEASURES	FINISHES	SAP	POINTS
60,5x13,5x49 / 23 <sup>7</sup> / <sub>8</sub> x5 <sup>3</sup> / <sub>8</sub> x19 <sup>1</sup> / <sub>4</sub>	GELCOAT	100241712	427
120,5x13,5x49 / 47 <sup>1</sup> / <sub>2</sub> x5 <sup>3</sup> / <sub>8</sub> x19 <sup>1</sup> / <sub>4</sub> (D/S)		100296392	898

## LEG

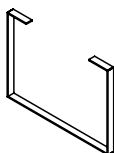

- Leg.
- Piedini
- Ножка.

MEASURES	FINISHES	SAP	POINTS
53x38,5x3 / 20 <sup>7</sup> / <sub>8</sub> x15 <sup>1</sup> / <sub>8</sub> x1 <sup>1</sup> / <sub>8</sub>	Blanco Brillo	100124694	0147
73x38,5x3 / 28 <sup>3</sup> / <sub>4</sub> x15 <sup>1</sup> / <sub>8</sub> x1 <sup>1</sup> / <sub>8</sub>		100125007	0173

## TALL CABINET

DEPTH 30CM / 11<sup>3</sup>/<sub>4</sub>"

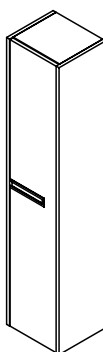

- Tall cabinet. DX / SX
- Modulo colonna. DX / SX
- Высокий шкаф. DX / SX

MEASURES	FINISHES	SAP	POINTS
34x160x30 / 13 <sup>3</sup> / <sub>8</sub> x63x11 <sup>3</sup> / <sub>4</sub>	Laminate Blanco Brillo	100304604	669
	Laminate Roble Root	100304605	

MC



## MIRROR

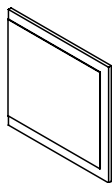

Mirror.  
Specchio  
Зеркало.

MEASURES	(  )	FINISHES	SAP	POINTS
60x60x2 / 23 <sup>5/8</sup> x23 <sup>5/8</sup> x0 <sup>3/4</sup>		Laminate Blanco Brillo	100117617	0156
		Laminate Roble Root	100304634	0145
80x60x2 / 31 <sup>1/2</sup> x23 <sup>5/8</sup> x0 <sup>3/4</sup>		Laminate Blanco Brillo	100126789	0203
		Laminate Roble Root	100304622	0189
120x60x2 / 47 <sup>1/4</sup> x23 <sup>5/8</sup> x0 <sup>3/4</sup>		Laminate Blanco Brillo	100171842	0303
		Laminate Roble Root	100304603	0304



The interpretation made in inches for the dimensions of the different items shown in the price list has been rounded to 1/8, however for a more accurate measurement please use millimetres or centimetres.

## Folk

<b>EXTERIOR FINISHES</b> FINITURE ESTERNE ОТДЕЛКА ДЛЯ НАРУЖНОГО ИСПОЛЬЗОВАНИЯ	<input checked="" type="checkbox"/> Laminate Laminato ЛАМИНАТ	<input type="checkbox"/> Matt lacquer Laccato opaco МАТОВЫЙ ЛАК	<input type="checkbox"/> Wood veneer Legno ДЕРЕВО
	<input type="checkbox"/> HPL Stratificato СЛОИСТАЯ	<input type="checkbox"/> Gloss lacquer Laccato lucido ГЛЯНЦЕВЫЙ ЛАК	
<b>INTERIOR FINISHES</b> FINITURE INTERNE ОТДЕЛКА ДЛЯ ВНУТРЕННЕГО ИСПОЛЬЗОВАНИЯ	<input checked="" type="checkbox"/> Laminate Laminato ЛАМИНАТ	<input type="checkbox"/> Wood veneer Legno ДЕРЕВО	<input type="checkbox"/> Aluminium+laminated base Alluminio + base in laminato Алюминий + основа из ламината
<b>HANDLES</b> MANIGLIE РУЧКИ	<input checked="" type="checkbox"/> Front handle Maniglia frontale a vista Декоративная передняя ручка	<input type="checkbox"/> Integrated metal handle Maniglia metallica integrata Встроенная металлическая ручка	<input type="checkbox"/> Integrated mechanized h. Maniglia integrata ricavata sul bordo Встроенная ручка по краю
	<input type="checkbox"/> Push handle Maniglia Push РУЧКИ Push		
<b>TYPE OF UNITS</b> TIPI DI MODULI ТИПЫ МОДУЛЕЙ	<input checked="" type="checkbox"/> Compact Compatto Компактная	<input type="checkbox"/> Modular Modulare Модульная	
<b>POSITION</b> POSIZIONE ПОЗИЦИЯ	<input checked="" type="checkbox"/> Wall-mounted Sospeso Подвесная	<input type="checkbox"/> Floor-mounted A terra Напольная	
<b>MEASURES (CM)</b> DIMENSIONI РАЗМЕРЫ	◀ 60 / 80 / 120 23 <sup>5/8</sup> / 31 <sup>1/2</sup> / 47 <sup>1/4</sup>	▲ 48 18 <sup>7/8</sup>	↘ 49 19 <sup>1/4</sup>
<b>WORKTOP &amp; BASIN OPTIONS</b> OPZIONI TOP E LAVABI ВАРИАНТЫ СТОЛЕШНИЦ И УМЫВАЛЬНЫХ РАКОВИН	<input type="checkbox"/> Bath serie's worktop / basin Lavabo / top della serie Серийная умывальная раковина / столешница	<input type="checkbox"/> Standard worktops Top standard Стандартные столешницы	<input checked="" type="checkbox"/> Worktop + integrated basin Encimera + lavabo integrato Столешница + встроенная умывальная раковина
	<input type="checkbox"/> Over-mounted basin Lavabo da appoggio Настольная умывальная раковина	<input type="checkbox"/> Under-mounted basin Lavabo sottopiano Умывальная раковина, встраиваемая в столешницу снизу	<input checked="" type="checkbox"/> Double basin as option Opzione doppia vasca Вариант с двойной чашей
<b>WORKTOP FINISHES</b> FINITURE TOP ОТДЕЛКА СТОЛЕШНИЦ	<input checked="" type="checkbox"/> Krion® worktop Top in KRION® Столешница KRION®	<input checked="" type="checkbox"/> Gel Coat worktop Top in Gel Coat Столешница с покрытием гелькоут	<input type="checkbox"/> Natural Stone worktop Top in pietra naturale Столешница из натурального камня.
	<input type="checkbox"/> Glass worktop Top in vetro Столешница из стекла	<input type="checkbox"/> Bath furniture finish worktop Top con la finitura del mobile Столешница с той же отделкой, что и консоль/тумба	
<b>BASIN FINISHES</b> FINITURE LAVABI ОТДЕЛКА УМЫВАЛЬНЫХ РАКОВИН	<input type="checkbox"/> Krion® basin Lavabo in Krion® Умывальная раковина из Krion®	<input type="checkbox"/> Gel Coat basin Lavabo Gelcoat Раковина Gelcoat	<input type="checkbox"/> Ceramic basin Lavabo in ceramica Керамическая умывальная раковина
	<input type="checkbox"/> Natural Stone basin Lavabo in pietra naturale Умывальная раковина из натурального камня.		
<b>ACCESSORIES</b> ACCESSORI АКСЕССУАРЫ	<input checked="" type="checkbox"/> Mirror Specchio Зеркало	<input type="checkbox"/> Wall-mounted module Modulo sospeso Подвесной модуль	<input checked="" type="checkbox"/> Tall cabinet Modulo colonna Высокий шкаф
	<input checked="" type="checkbox"/> Upper unit Modulo alto Верхний модуль	<input checked="" type="checkbox"/> Organizer Organizzatore Органайзер	<input type="checkbox"/> Shelves Mensola Полка
			<input type="checkbox"/> Accessories Accessori Аксессуары

# folk



Series made up of a suspended washbasin unit with two drawers. The base, sides and handles come in a Lino laminate finish, whilst the interiors feature a Textil laminate finish. The drawer front panels are available in laminate Ice, Camel or Blanco finishes. The Krion vanity top comes with an integrated basin. This series also includes a mirror with a Lino laminate finish and a drawer organizer.

Serie composta da modulo portalavabo sospeso con due cassetti con base, fianchi e maniglia in finitura laminato Lino, interno in laminato Textil e frontali dei cassetti in finitura laminato Ice, Camel o Blanco lucido. Top in KRION con lavabo integrato. La serie è completata da uno specchio in finitura laminato Lino e da un organizer per il cassetto.

В серию входит подвесная умывальная раковина с двумя выдвижными ящиками. Основание, боковые стороны и ручки отделаны ламинатом Lino, а внутренние поверхности — ламинатом Textil. Варианты отделки фасадов выдвижных ящиков: ламинат Ice, Camel, Blanco Brillo. Поверхность тумбы выполнена из материала Krion и оборудована встроенной раковиной. В серию также входят зеркало с отделкой ламинатом Lino и органайзер с выдвижными ящиками.



+info p.393

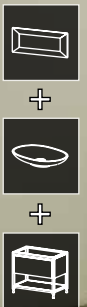

**1923 Points**  
**FOLK Lino / Ice**

## FINISHES

LAMINATE

LAMINATO

ЛАМИНАТ

Fronts  
Frontali  
Фасады



Ice



Camel

Interior  
Interno  
Внутренняя



Textil

Carcass  
Scocca  
Каркас



Lino

## WASH BASIN UNIT BPS-1

DEPTH 49,2CM / 19<sup>3/8</sup>"

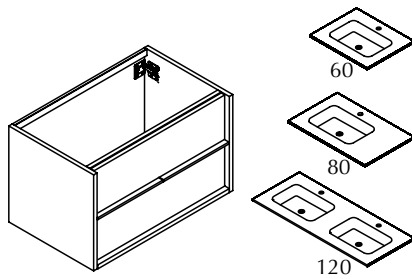

- Wash basin unit.
- Inside drawer organiser can be incorporated.
- Basi portalavabo
- Possibilità di incorporare organizer per il cassetto interno.
- Тумбочка под умывальник.
- Возможность встроить внутренний органайзер с выдвижными ящиками.

MEASURES	(xx)	FINISHES	SAP	POINTS
60x48x49,2 / 23 <sup>5/8</sup> x18 <sup>7/8</sup> x19 <sup>3/8</sup>		Camel	100210798	978
		Ice	100210799	978
80x48x49,2 / 31 <sup>1/2</sup> x18 <sup>7/8</sup> x19 <sup>3/8</sup>		Camel	100210804	1065
		Ice	100210805	1065
120x48x49,2 / 47 <sup>1/4</sup> x18 <sup>7/8</sup> x19 <sup>3/8</sup>		Camel	100210795	1290
		Ice	100210796	1290

## WASH BASIN UNIT BPS-2

DEPTH 49,2CM / 19<sup>3/8</sup>"

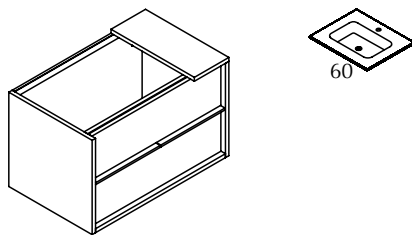

- Wash basin unit.
- Inside drawer organiser can be incorporated.
- Basi portalavabo
- Possibilità di incorporare organizer per il cassetto interno.
- Тумбочка под умывальник.
- Возможность встроить внутренний органайзер с выдвижными ящиками.

MEASURES	(xx)	FINISHES	SAP	POINTS
80x50x49,2 / 31 <sup>1/2</sup> x19 <sup>5/8</sup> x19 <sup>3/8</sup>		Camel	100210802	1075
		Ice	100210800	1075

BP

## KRION STONE WORKTOP

DEPTH 49,2CM / 19<sup>3/8</sup>"

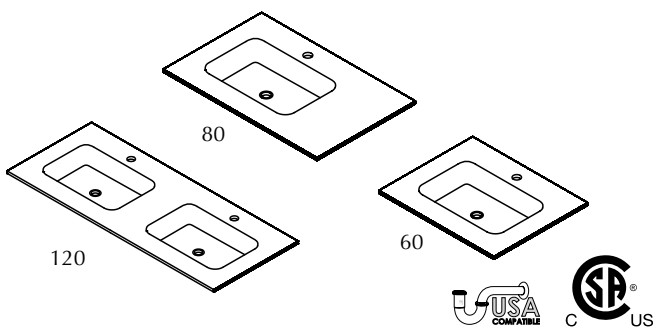

- KRION STONE worktop with integrated basin.
- Requires for installation permanent valve SAP 100036254, 68 P.
- Requires drainage SAP 100036255, 103 P.
- Top in KRION STONE con lavabo integrato.
- Richiede valvola SAP 100036254, 68 P.
- Richiede scarico SAP 100036255, 103 P.
- Столешница KRION STONE со встроенной раковиной.
- Требуется установка постоянного клапана SAP 100036254, 68 P.
- Требуется дренаж SAP 100036255, 103 P.

MEASURES	(xx)	FINISHES	SAP	POINTS
60,2x13x49,2 / 23 <sup>5/8</sup> x5 <sup>1/8</sup> x19 <sup>3/8</sup>		Kרון STONE	100091017	617
80,2x13x49,2 / 31 <sup>1/2</sup> x5 <sup>1/8</sup> x19 <sup>3/8</sup>			100091018	660
120,2x13x49,2 / 47 <sup>3/8</sup> x5 <sup>1/8</sup> x19 <sup>3/8</sup>			100110448	1356

folk

EN

## GELCOAT BASIN

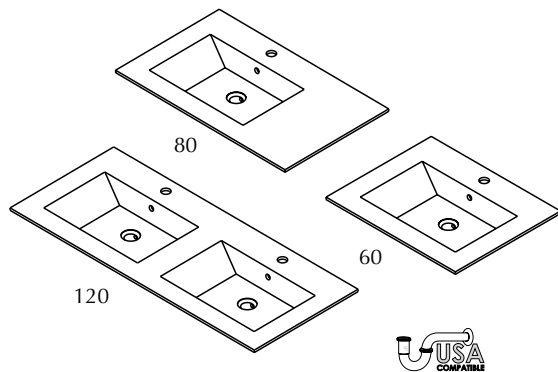

- GELCOAT basin with overflow.
- Requires for installation valve SAP 100200010, 72 P.
- Lavabo GELCOAT con troppopieno.
- Richiede valvola SAP 100200010, 72 P.
- Раковина GELCOAT с переливом.
- Требуется установка клапана SAP 100200010, 72 P.

MEASURES	FINISHES	SAP	POINTS
60,5x14,1x49,2 / 23 <sup>7/8</sup> x5 <sup>1/2</sup> x19 <sup>3/8</sup>	GELCOAT	100160956	0560
80,5x14,1x49,2 / 31 <sup>3/4</sup> x5 <sup>1/2</sup> x19 <sup>3/8</sup>		100160957	0582
120,5x14,1x49,2 / 47 <sup>1/2</sup> x5 <sup>1/2</sup> x19 <sup>3/8</sup>		100171860	0981

## SLIM BASIN

DEPTH 49CM / 19<sup>1/4</sup>"

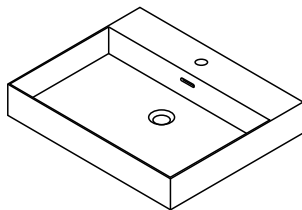

- GELCOAT basin with overflow.
- Requires for installation valve SAP 100200010, 72 P.
- Lavabo GELCOAT con troppopieno.
- Richiede valvola SAP 100200010, 72 P.
- Раковина GELCOAT с переливом.
- Требуется установка клапана SAP 100200010, 72 P.

MEASURES	FINISHES	SAP	POINTS
60x10x49 / 23 <sup>5/8</sup> x3 <sup>7/8</sup> x19 <sup>1/4</sup>	GELCOAT	100221199	596

## ORGANISER MB (Travat / Folk)

DEPTH 37CM / 14<sup>5/8</sup>"

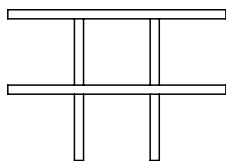

- Organiser. For inside drawer.
- Organizer. Per interno cassetto.
- Организер. Для внутреннего выдвижного ящика.

MEASURES	FINISHES	SAP	POINTS
27x10x37 / 10 <sup>5/8</sup> x3 <sup>7/8</sup> x14 <sup>5/8</sup>	Textil	100215109	126

## TALL CABINET

DEPTH 30CM / 11<sup>3/4</sup>"



- Tall cabinet. DX / SX
- Modulo colonna. DX / SX
- Высокий шкаф. DX / SX

MEASURES	FINISHES	SAP	POINTS
30x156x30 / 11 <sup>3/4</sup> x61 <sup>3/8</sup> x11 <sup>3/4</sup>	Camel	100095695	828
	Ice	100095696	828



## MIRROR

DEPTH 2,1CM / 0<sup>7</sup>/<sub>8</sub>"

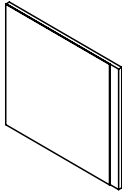

- Mirror.
- Specchio
- Зеркало.

MEASURES	(  )	FINISHES	SAP	POINTS
50x60x2,1 / 19 <sup>5</sup> / <sub>8</sub> x23 <sup>5</sup> / <sub>8</sub> x0 <sup>7</sup> / <sub>8</sub>			100091019	172
65x60x2,1 / 25 <sup>5</sup> / <sub>8</sub> x23 <sup>5</sup> / <sub>8</sub> x0 <sup>7</sup> / <sub>8</sub>		Lino	100091020	198
116x60x2,1 / 45 <sup>5</sup> / <sub>8</sub> x23 <sup>5</sup> / <sub>8</sub> x0 <sup>7</sup> / <sub>8</sub>			100110465	358

## MIRROR

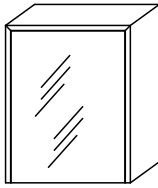

- Upper unit with door and mirror front.
- Pensile con anta e frontale a specchio.
- Верхний блок с дверцей и зеркальным фасадом.

MEASURES	(  )	FINISHES	OPENS	SAP	POINTS
49x62x22 / 19 <sup>1</sup> / <sub>4</sub> x24 <sup>3</sup> / <sub>8</sub> x8 <sup>5</sup> / <sub>8</sub>				100115789	
49x62x16 / 19 <sup>1</sup> / <sub>4</sub> x24 <sup>3</sup> / <sub>8</sub> x6 <sup>1</sup> / <sub>4</sub>		Lino	SX	100120938	558

## MIRROR

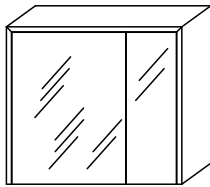

- Upper unit with door and mirror front.
- Pensile con anta e frontale a specchio.
- Верхний блок с дверцей и зеркальным фасадом.

MEASURES	(  )	FINISHES	SAP	POINTS
69x62x22 / 27 <sup>1</sup> / <sub>8</sub> x24 <sup>3</sup> / <sub>8</sub> x8 <sup>5</sup> / <sub>8</sub>			100115790	
69x62x16 / 27 <sup>1</sup> / <sub>8</sub> x24 <sup>3</sup> / <sub>8</sub> x6 <sup>1</sup> / <sub>4</sub>		Lino	100120939	682



The interpretation made in inches for the dimensions of the different items shown in the price list has been rounded to 1/8, however for a more accurate measurement please use millimetres or centimetres.

## Travat

<b>EXTERIOR FINISHES</b> FINITURE ESTERNE ОТДЕЛКА ДЛЯ НАРУЖНОГО ИСПОЛЬЗОВАНИЯ	<input checked="" type="checkbox"/> Laminate Laminato ЛАМИНАТ	<input type="checkbox"/> Matt lacquer Laccato opaco МАТОВЫЙ ЛАК	<input type="checkbox"/> Wood veneer Legno ДЕРЕВО
	<input type="checkbox"/> HPL Stratificato СЛОИСТАЯ	<input type="checkbox"/> Gloss lacquer Laccato lucido ГЛЯНЦЕВЫЙ ЛАК	
<b>INTERIOR FINISHES</b> FINITURE INTERNE ОТДЕЛКА ДЛЯ ВНУТРЕННЕГО ИСПОЛЬЗОВАНИЯ	<input checked="" type="checkbox"/> Laminate Laminato ЛАМИНАТ	<input type="checkbox"/> Wood veneer Legno ДЕРЕВО	<input type="checkbox"/> Aluminium+laminated base Alluminio + base in laminato Алюминий + основа из ламината
	<input type="checkbox"/> Front handle Maniglia frontale a vista Декоративная передняя ручка	<input checked="" type="checkbox"/> Integrated metal handle Maniglia metallica integrata Встроенная металлическая ручка	<input type="checkbox"/> Integrated mechanized h. Maniglia integrata ricavata sul bordo Встроенная ручка по краю
<b>HANDLES</b> MANIGLIE РУЧКИ	<input type="checkbox"/> Push handle Maniglia Push РУЧКИ Push		
<b>TYPE OF UNITS</b> TIPI DI MODULI ТИПЫ МОДУЛЕЙ	<input checked="" type="checkbox"/> Compact Compatto Компактная	<input type="checkbox"/> Modular Modulare Модульная	
<b>POSITION</b> POSIZIONE ПОЗИЦИЯ	<input checked="" type="checkbox"/> Wall-mounted Sospeso Подвесная	<input checked="" type="checkbox"/> Floor-mounted A terra Напольная	
<b>MEASURES (CM)</b> DIMENSIONI РАЗМЕРЫ	60 / 80 / 120	53 / 87	49
	23 <sup>5/8</sup> / 31 <sup>1/2</sup> / 47 <sup>1/4</sup>	20 <sup>7/8</sup> / 34 <sup>1/4</sup>	19 <sup>1/4</sup>
<b>WORKTOP &amp; BASIN OPTIONS</b> OPZIONI TOP E LAVABI ВАРИАНТЫ СТОЛЕШНИЦ И УМЫВАЛЬНЫХ РАКОВИН	<input type="checkbox"/> Bath serie's worktop / basin Lavabo / top della serie Серийная умывальная раковина / столешница	<input type="checkbox"/> Standard worktops Top standard Стандартные столешницы	<input checked="" type="checkbox"/> Worktop + integrated basin Encimera + lavabo integrato Столешница + встроенная умывальная раковина
	<input type="checkbox"/> Over-mounted basin Lavabo da appoggio Настольная умывальная раковина	<input type="checkbox"/> Under-mounted basin Lavabo sottopiano Умывальная раковина, встраиваемая в столешницу снизу	<input checked="" type="checkbox"/> Double basin as option Opzione doppia vasca Вариант с двойной чашей
<b>WORKTOP FINISHES</b> FINITURE TOP ОТДЕЛКА СТОЛЕШНИЦ	<input checked="" type="checkbox"/> Krion® worktop Top in KRION® Столешница KRION®	<input checked="" type="checkbox"/> Gel Coat worktop Top in Gel Coat Столешница с покрытием гелькоут	<input type="checkbox"/> Natural Stone worktop Top in pietra naturale Столешница из натурального камня.
	<input type="checkbox"/> Glass worktop Top in vetro Столешница из стекла	<input type="checkbox"/> Bath furniture finish worktop Top con la finitura del mobile Столешница с той же отделкой, что и консоль/тумба	
<b>BASIN FINISHES</b> FINITURE LAVABI ОТДЕЛКА УМЫВАЛЬНЫХ РАКОВИН	<input type="checkbox"/> Krion® basin Lavabo in Krion® Умывальная раковина из Krion®	<input type="checkbox"/> Gel Coat basin Lavabo Gelcoat Раковина Gelcoat	<input type="checkbox"/> Ceramic basin Lavabo in ceramica Керамическая умывальная раковина
	<input type="checkbox"/> Natural Stone basin Lavabo in pietra naturale Умывальная раковина из натурального камня.		
<b>ACCESSORIES</b> ACCESSORI АКСЕССУАРЫ	<input checked="" type="checkbox"/> Mirror Specchio Зеркало	<input type="checkbox"/> Wall-mounted module Modulo sospeso Подвесной модуль	<input checked="" type="checkbox"/> Tall cabinet Modulo colonna Высокий шкаф
	<input checked="" type="checkbox"/> Upper unit Modulo alto Верхний модуль	<input checked="" type="checkbox"/> Organizer Organizzatore Органайзер	<input type="checkbox"/> Shelves Mensola Полка
			<input type="checkbox"/> Accessories Accessori Аксессуары

# travat



A bathroom series made up of a hung washbasin unit with two drawers and recessed handles, or alternatively a floor standing washbasin module with three drawers and recessed handles. The interiors come in a Textil laminate finish whilst the exteriors are available in a laminate Camel or Fume finish. The Krion vanity top comes with an integrated basin.

This series also includes a mirror in the same finish as the exterior furniture finish and a drawer organizer.

Serie da bagno composta da un modulo portalavabo sospeso con due cassetti e maniglia integrata o da un modulo portalavabo a terra con tre cassetti e maniglia integrata. Interno in finitura laminato

Textil ed esterno in finitura laminato Camel o Fume. Top in KRION con lavabo integrato.

La serie si compone anche di specchio nella stessa finitura dell'interno del mobile e di organizer per il cassetto.

Серия мебели для ванной комнаты, а которую входят подвесной тумбочка под умывальник с двумя выдвижными ящиками с утопленными ручками или напольный модуль, состоящий из умывальной раковины и трех выдвижных ящиков с утопленными ручками. Для внутренней отделки используется ламинат Textil, наружные поверхности могут быть отделаны ламинатом Camel или Fume. Поверхность тумбы выполнена из материала Krion и оборудована встроенной раковиной.

В серию входит зеркало с той же отделкой, что и наружные поверхности мебели, а также органайзер с выдвижным ящиком.



1951 Points  
TRAVAT Fume

+info p.394



travat

+info p.394

**3090 Points**  
**TRAVAT Camel**

## FINISHES

LAMINATE

LAMINATO

ЛАМИНАТ

Exterior  
Esterno:

Наружная отделка

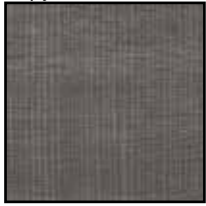

Fume



Camel



Blanco

Interior  
Interno

Внутренняя отделка



Textil

## WASH BASIN UNIT BPS

DEPTH 49,2CM / 19<sup>3/8</sup>"

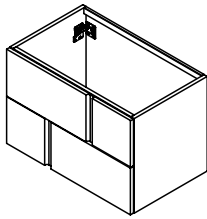

Wash basin unit.  
Basi portalavabo  
Тумбочка под умывальник.



MEASURES	(xx)	FINISHES	SAP	POINTS
60x52,8x49,2 / 23 <sup>5/8</sup> x20 <sup>3/4</sup> x19 <sup>3/8</sup>		Blanco	100144935	962
		Camel	100144936	
		Fume	100144937	
80x52,8x49,2 / 31 <sup>1/2</sup> x20 <sup>3/4</sup> x19 <sup>3/8</sup>		Blanco	100144946	1075
		Camel	100091031	
		Fume	100091032	
120x52,8x49,2 / 47 <sup>1/4</sup> x20 <sup>3/4</sup> x19 <sup>3/8</sup>		Blanco	100144934	1337
		Camel	100110453	
		Fume	100110463	

## WASH BASIN UNIT BPT

DEPTH 49,2CM / 19<sup>3/8</sup>"

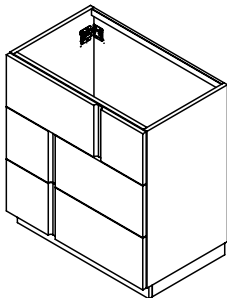

Wash basin unit.  
Basi portalavabo  
Тумбочка под умывальник.



MEASURES	(xx)	FINISHES	SAP	POINTS
60x87x49,2 / 23 <sup>5/8</sup> x34 <sup>1/4</sup> x19 <sup>3/8</sup>		Blanco	100144939	1117
		Camel	100144940	
		Fume	100144941	
80x87x49,2 / 31 <sup>1/2</sup> x34 <sup>1/4</sup> x19 <sup>3/8</sup>		Blanco	100144970	1290
		Camel	100091033	
		Fume	100091034	
120x87x49,2 / 47 <sup>1/4</sup> x34 <sup>1/4</sup> x19 <sup>3/8</sup>		Blanco	100144938	1616
		Camel	100110454	
		Fume	100110455	

## KRION STONE WORKTOP

DEPTH 49,2CM / 19<sup>3/8</sup>"

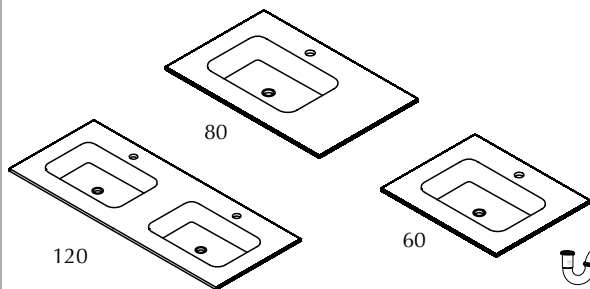

- KRION STONE Worktop with integrated basin.
- Requires for installation permanent valve SAP 100036254, 68 P.
- Top in KRION STONE con lavabo integrato.
- Richiede valvola SAP 100036254, 68 P.
- Столешница KRION STONE со встроенной раковиной.
- Требуется установка постоянного клапана SAP 100036254, 68 P.



MEASURES	FINISHES	SAP	POINTS
60,2x13x49,2 / 23 <sup>5/8</sup> x5 <sup>1/8</sup> x19 <sup>3/8</sup>	Krion STONE	100091017	617
80,2x13x49,2 / 31 <sup>1/2</sup> x5 <sup>1/8</sup> x19 <sup>3/8</sup>		100091018	660
120,2x13x49,2 / 47 <sup>3/8</sup> x5 <sup>1/8</sup> x19 <sup>3/8</sup>		100110448	1356

## BASIN

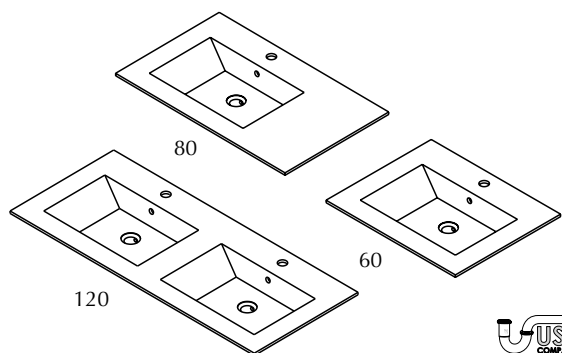

- GELCOAT basin with overflow.
- Requires for installation valve SAP 100200010, 72 P.
- Lavabo GELCOAT con troppopieno.
- Richiede valvola SAP 100200010, 72 P.
- Раковина GELCOAT с переливом.
- Требуется установка клапана SAP 100200010, 72 P.



EN

MEASURES	FINISHES	SAP	POINTS
60,5x14,1x49,2 / 23 <sup>7/8</sup> x5 <sup>1/2</sup> x19 <sup>3/8</sup>	GELCOAT	100160956	0560
80,5x14,1x49,2 / 31 <sup>3/4</sup> x5 <sup>1/2</sup> x19 <sup>3/8</sup>		100160957	0582
120,5x14,1x49,2 / 47 <sup>1/2</sup> x5 <sup>1/2</sup> x19 <sup>3/8</sup>		100171860	0981

## SLIM BASIN

DEPTH 49CM / 19<sup>1/4</sup>"

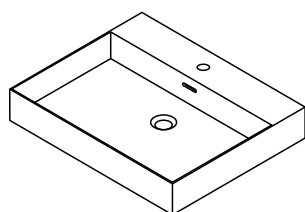

- GELCOAT basin with overflow.
- Requires for installation valve SAP 100200010, 72 P.
- Lavabo GELCOAT con troppopieno.
- Richiede valvola SAP 100200010, 72 P.
- Раковина GELCOAT с переливом.
- Требуется установка клапана SAP 100200010, 72 P.

MEASURES	FINISHES	SAP	POINTS
60x10x49 / 23 <sup>5/8</sup> x3 <sup>7/8</sup> x19 <sup>1/4</sup>	GELCOAT (BPS ONLY)	100221199	596

## FIT BASIN

DEPTH 49CM / 19<sup>1/4</sup>"

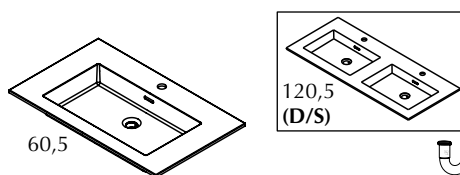

- GELCOAT basin with overflow.
- Requires for installation valve SAP 100200010, 72 P.
- Lavabo GELCOAT con troppopieno.
- Richiede valvola SAP 100200010, 72 P.
- Раковина GELCOAT с переливом.
- Требуется установка клапана SAP 100200010, 72 P.

MEASURES	FINISHES	SAP	POINTS
60,5x13,5x49 / 23 <sup>7/8</sup> x5 <sup>3/8</sup> x19 <sup>1/4</sup>	GELCOAT	100241712	427
120,5x13,5x49 / 47 <sup>1/2</sup> x5 <sup>3/8</sup> x19 <sup>1/4</sup> (D/S)		100296392	898



## MIRROR

DEPTH 2,1CM / 0<sup>7</sup>/<sub>8</sub>"

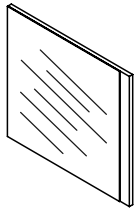

- Mirror.
- Specchio.
- Зеркало.

MEASURES	(xx)	FINISHES	SAP	POINTS
65x60x2,1 / 25 <sup>5</sup> / <sub>8</sub> x23 <sup>5</sup> / <sub>8</sub> x0 <sup>7</sup> / <sub>8</sub>		Blanco	100144917	216
		Camel	100091021	
		Fume	100091022	
116x60x2,1 / 45 <sup>5</sup> / <sub>8</sub> x23 <sup>5</sup> / <sub>8</sub> x0 <sup>7</sup> / <sub>8</sub>		Blanco	100144916	358
		Camel	100110458	
		Fume	100110459	

## MIRROR

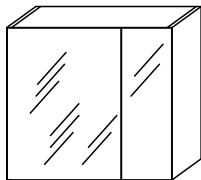

- Upper unit with door and mirror front.
- Pensile con anta e frontale a specchio.
- Верхний блок с дверцей и зеркальным фасадом.

MEASURES	(xx)	FINISHES	SAP	POINTS
65x60x20 / 25 <sup>5</sup> / <sub>8</sub> x23 <sup>5</sup> / <sub>8</sub> x7 <sup>7</sup> / <sub>8</sub>		Camel	100115791	664
		Fume	100115792	
65x60x15 / 25 <sup>5</sup> / <sub>8</sub> x23 <sup>5</sup> / <sub>8</sub> x5 <sup>7</sup> / <sub>8</sub>		Blanco	100144943	664
		Camel	100120940	
		Fume	100120941	

## ORGANISER MB (Travat / Folk)

DEPTH 37CM / 14<sup>5</sup>/<sub>8</sub>"

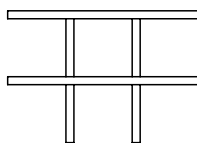

- Organiser. For inside drawer.
- Organizer. Per interno cassetto.
- Организер. Для внутреннего выдвижного ящика.

MEASURES	(xx)	FINISHES	SAP	POINTS
27x10x37 / 10 <sup>5</sup> / <sub>8</sub> x3 <sup>7</sup> / <sub>8</sub> x14 <sup>5</sup> / <sub>8</sub>		Textil	100215109	126

## TALL CABINET

DEPTH 30CM / 11<sup>3</sup>/<sub>4</sub>"



- Tall cabinet. DX / SX.
- Modulo colonna. DX / SX.
- Высокий шкаф. DX / SX.

MEASURES	(xx)	FINISHES	SAP	POINTS
30x160x30 / 11 <sup>3</sup> / <sub>4</sub> x63x11 <sup>3</sup> / <sub>4</sub>		Blanco	100144944	924
		Camel	100095697	
		Fume	100095698	



The interpretation made in inches for the dimensions of the different items shown in the price list has been rounded to 1/8, however for a more accurate measurement please use millimetres or centimetres.

## Dock

<b>EXTERIOR FINISHES</b> FINITURE ESTERNE ОТДЕЛКА ДЛЯ НАРУЖНОГО ИСПОЛЬЗОВАНИЯ	<input checked="" type="checkbox"/> Laminate Laminato ЛАМИНАТ	<input type="checkbox"/> Matt lacquer Laccato opaco МАТОВЫЙ ЛАК	<input type="checkbox"/> Wood veneer Legno ДЕРЕВО
	<input type="checkbox"/> HPL Stratificato СЛОИСТАЯ	<input type="checkbox"/> Gloss lacquer Laccato lucido ГЛЯНЦЕВЫЙ ЛАК	
<b>INTERIOR FINISHES</b> FINITURE INTERNE ОТДЕЛКА ДЛЯ ВНУТРЕННЕГО ИСПОЛЬЗОВАНИЯ	<input checked="" type="checkbox"/> Laminate Laminato ЛАМИНАТ	<input type="checkbox"/> Wood veneer Legno ДЕРЕВО	<input type="checkbox"/> Aluminium+laminated base Alluminio + base in laminato Алюминий + основа из ламината
<b>HANDLES</b> MANIGLIE РУЧКИ	<input checked="" type="checkbox"/> Front handle Maniglia frontale a vista Декоративная передняя ручка	<input type="checkbox"/> Integrated metal handle Maniglia metallica integrata Встроенная металлическая ручка	<input type="checkbox"/> Integrated mechanized h. Maniglia integrata ricavata sul bordo Встроенная ручка по краю
	<input type="checkbox"/> Push handle Maniglia Push РУЧКИ Push		
<b>TYPE OF UNITS</b> TIPI DI MODULI ТИПЫ МОДУЛЕЙ	<input checked="" type="checkbox"/> Compact Compatto Компактная	<input type="checkbox"/> Modular Modulare Модульная	
<b>POSITION</b> POSIZIONE ПОЗИЦИЯ	<input checked="" type="checkbox"/> Wall-mounted Sospeso Подвесная	<input type="checkbox"/> Floor-mounted A terra Напольная	
<b>MEASURES (CM)</b> DIMENSIONI РАЗМЕРЫ	60 / 80	48	48
	23 <sup>5/8</sup> / 31 <sup>1/2</sup>	18 <sup>7/8</sup>	18 <sup>7/8</sup>
<b>WORKTOP &amp; BASIN OPTIONS</b> OPZIONI TOP E LAVABI ВАРИАНТЫ СТОЛЕШНИЦ И УМЫВАЛЬНЫХ РАКОВИН	<input type="checkbox"/> Bath serie's worktop / basin Lavabo / top della serie Серийная умывальная раковина / столешница	<input type="checkbox"/> Standard worktops Top standard Стандартные столешницы	<input checked="" type="checkbox"/> Worktop + integrated basin Encimera + lavabo integrato Столешница + встроенная умывальная раковина
	<input type="checkbox"/> Over-mounted basin Lavabo da appoggio Настольная умывальная раковина	<input type="checkbox"/> Under-mounted basin Lavabo sottopiano Умывальная раковина, встраиваемая в столешницу снизу	<input type="checkbox"/> Double basin as option Opzione doppia vasca Вариант с двойной чашей
<b>WORKTOP FINISHES</b> FINITURE TOP ОТДЕЛКА СТОЛЕШНИЦ	<input type="checkbox"/> Krion® worktop Top in KRION® Столешница KRION®	<input checked="" type="checkbox"/> Gel Coat worktop Top in Gel Coat Столешница с покрытием гелькоут	<input type="checkbox"/> Natural Stone worktop Top in pietra naturale Столешница из натурального камня.
	<input type="checkbox"/> Glass worktop Top in vetro Столешница из стекла	<input type="checkbox"/> Bath furniture finish worktop Top con la finitura del mobile Столешница с той же отделкой, что и консоль/тумба	
<b>BASIN FINISHES</b> FINITURE LAVABI ОТДЕЛКА УМЫВАЛЬНЫХ РАКОВИН	<input type="checkbox"/> Krion® basin Lavabo in Krion® Умывальная раковина из Krion®	<input type="checkbox"/> Gel Coat basin Lavabo Gelcoat Раковина Gelcoat	<input type="checkbox"/> Ceramic basin Lavabo in ceramica Керамическая умывальная раковина
	<input type="checkbox"/> Natural Stone basin Lavabo in pietra naturale Умывальная раковина из натурального камня.		
<b>ACCESSORIES</b> ACCESSORI АКСЕССУАРЫ	<input checked="" type="checkbox"/> Mirror Specchio Зеркало	<input type="checkbox"/> Wall-mounted module Modulo sospeso Подвесной модуль	<input type="checkbox"/> Tall cabinet Modulo colonna Высокий шкаф
	<input type="checkbox"/> Upper unit Modulo alto Верхний модуль	<input type="checkbox"/> Organizer Organizzatore Органайзер	<input type="checkbox"/> Shelves Mensola Полка
			<input type="checkbox"/> Accessories Accessori Аксессуары

# dock



Wall-hung bathroom cabinet. Equipped with a drawer pulled-out by hand and a space to clear the trap. The series includes mirror, Gelcoat basin.

Mobile da bagno sospeso. Dispone di un cassetto ad estrazione manuale e foro per sifone. La serie è completata da uno specchio.

Шкаф, монтирующийся на стену, для ванной комнаты. Оборудован выдвижным ящиком. Предусмотрено пространство, позволяющее осуществлять чистку сифона. В эту серию входят зеркало и раковина Gelcoat.



+info p.394



1226 Points  
DOCK roble carbón

## FINISHES

LAMINATE

LAMINATO

ЛАМИНАТ

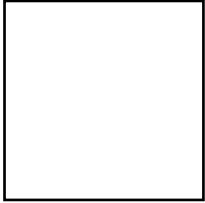

Blanco Brillo



Roble Carbón

## WASH BASIN UNIT

DEPTH 48CM / 18<sup>7</sup>/<sub>8</sub>"

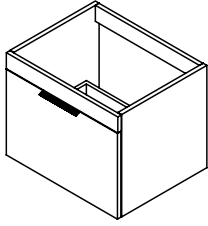

Wash basin unit.  
Basi portalavabo  
Тумбочка под умывальник.



MEASURES	(xx)	FINISHES	SAP	POINTS
60x48x48	/ 23 <sup>5</sup> / <sub>8</sub> x18 <sup>7</sup> / <sub>8</sub> x18 <sup>7</sup> / <sub>8</sub>	Blanco brillo	100210791	491
		Roble carbón	100314858	491

## WASH BASIN UNIT

DEPTH 48CM / 18<sup>7</sup>/<sub>8</sub>"

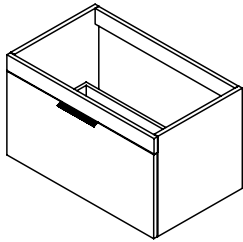

Wash basin unit.  
Basi portalavabo  
Тумбочка под умывальник.



MEASURES	(xx)	FINISHES	SAP	POINTS
80x48x48	/ 31 <sup>1</sup> / <sub>2</sub> x18 <sup>7</sup> / <sub>8</sub> x18 <sup>7</sup> / <sub>8</sub>	Blanco brillo	100219039	585
		Roble carbón	100314873	585

## WASH BASIN UNIT

DEPTH 48CM / 18<sup>7</sup>/<sub>8</sub>"

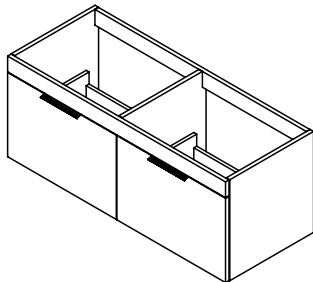

Wash basin unit.  
Basi portalavabo  
Тумбочка под умывальник.



MEASURES	(xx)	FINISHES	SAP	POINTS
120x48x48	/ 47 <sup>1</sup> / <sub>4</sub> x18 <sup>7</sup> / <sub>8</sub> x18 <sup>7</sup> / <sub>8</sub>	Blanco brillo	100241710	1109
		Roble carbón	100314882	1109

BP

## MIRROR

DEPTH 3CM / 1<sup>1</sup>/<sub>8</sub>"

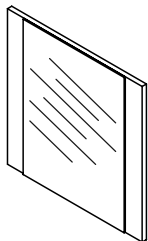

Mirror.  
Specchio  
Зеркало.

MEASURES	(xx)	FINISHES	SAP	POINTS
60x60x3	/ 23 <sup>5</sup> / <sub>8</sub> x 23 <sup>5</sup> / <sub>8</sub> x1 <sup>1</sup> / <sub>8</sub>	Blanco brillo	100203967	175
80x60x3	/ 31 <sup>1</sup> / <sub>2</sub> x 23 <sup>5</sup> / <sub>8</sub> x1 <sup>1</sup> / <sub>8</sub>		100219046	229
120x60x3	/ 47 <sup>1</sup> / <sub>4</sub> x 23 <sup>5</sup> / <sub>8</sub> x1 <sup>1</sup> / <sub>8</sub>		100241678	335
60x60x3	/ 23 <sup>5</sup> / <sub>8</sub> x 23 <sup>5</sup> / <sub>8</sub> x1 <sup>1</sup> / <sub>8</sub>	Roble carbón	100314870	175
80x60x3	/ 31 <sup>1</sup> / <sub>2</sub> x 23 <sup>5</sup> / <sub>8</sub> x1 <sup>1</sup> / <sub>8</sub>		100314880	229
120x60x3	/ 47 <sup>1</sup> / <sub>4</sub> x 23 <sup>5</sup> / <sub>8</sub> x1 <sup>1</sup> / <sub>8</sub>		100314853	335

ES

**GELCOAT BASIN**

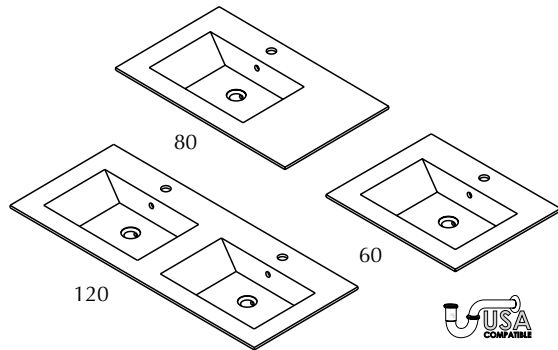

- GELCOAT basin with overflow.
- Requires for installation valve SAP 100200010, 72 P.
- Lavabo GELCOAT con troppopieno.
- Richiede valvola SAP 100200010, 72 P.
- Раковина GELCOAT с переливом.
- Требуется установка клапана SAP 100200010, 72 P.

MEASURES	FINISHES	SAP	POINTS
60,5x14,1x49,2 / 23 <sup>7/8</sup> x5 <sup>1/2</sup> x19 <sup>3/8</sup>	GELCOAT	100160956	0560
80,5x14,1x49,2 / 31 <sup>3/4</sup> x5 <sup>1/2</sup> x19 <sup>3/8</sup>		100160957	0582
120,5x14,1x49,2 / 47 <sup>1/2</sup> x5 <sup>1/2</sup> x19 <sup>3/8</sup>		100171860	0981

**KRION STONE WORKTOP**

**DEPTH 49,2CM / 19<sup>3/8</sup>"**

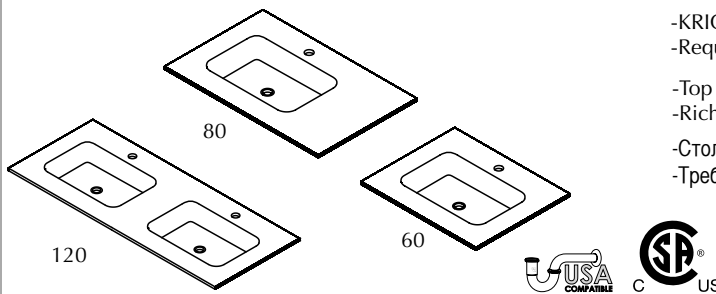

- KRION estone Worktop with integrated basin.
- Requires for installation permanent valve SAP 100036254, 68 P.
- Top in KRION STONE con lavabo integrato.
- Richiede valvola SAP 100036254, 68 P.
- Столешница KRION STONE со встроенной раковиной.
- Требуется установка постоянного клапана SAP 100036254, 68 P.

MEASURES	FINISHES	SAP	POINTS
60,2x13x49,2 / 23 <sup>5/8</sup> x5 <sup>1/8</sup> x19 <sup>3/8</sup>	Krión STON wor xE	100091017	617
80,2x13x49,2 / 31 <sup>1/2</sup> x5 <sup>1/8</sup> x19 <sup>3/8</sup>		100091018	660
120,2x13x49,2 / 47 <sup>3/8</sup> x5 <sup>1/8</sup> x19 <sup>3/8</sup>		100110448	1356

**SLIM BASIN**

**DEPTH 49CM / 19<sup>1/4</sup>"**

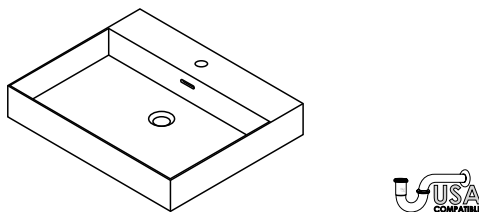

- GELCOAT basin with overflow.
- Requires for installation valve SAP 100200010, 72 P.
- Lavabo GELCOAT con troppopieno.
- Richiede valvola SAP 100200010, 72 P.
- Раковина GELCOAT с переливом.
- Требуется установка клапана SAP 100200010, 72 P.

MEASURES	FINISHES	SAP	POINTS
60x10x49 / 23 <sup>5/8</sup> x3 <sup>7/8</sup> x19 <sup>1/4</sup>	GELCOAT	100221199	596
80x10x49 / 31 <sup>1/2</sup> x3 <sup>7/8</sup> x19 <sup>1/4</sup>		100221201	682

**FIT BASIN**

**DEPTH 49CM / 19<sup>1/4</sup>"**

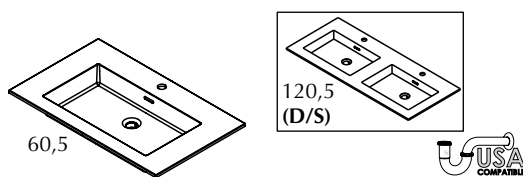

- GELCOAT basin with overflow.
- Requires for installation valve SAP 100200010, 72 P.
- Lavabo GELCOAT con troppopieno.
- Richiede valvola SAP 100200010, 72 P.
- Раковина GELCOAT с переливом.
- Требуется установка клапана SAP 100200010, 72 P.

MEASURES	FINISHES	SAP	POINTS
60,5x13,5x49 / 23 <sup>7/8</sup> x5 <sup>3/8</sup> x19 <sup>1/4</sup>	GELCOAT	100241712	427
80,5x13,5x49 / 31 <sup>3/4</sup> x5 <sup>3/8</sup> x19 <sup>1/4</sup>		100241723	532
120,5x13,5x49 / 47 <sup>1/2</sup> x5 <sup>3/8</sup> x19 <sup>1/4</sup> (D/S)		100296392	898









## sets

highline 380

skyline 390

## PLAY



ARTICLE	SAP	POINTS
Wash basin unit 60 Xtone Nylo Noir Pulido	700031534	2410
Basin PLAY 60 Xtone Nylo Noir Pulido	700031505	3762
Drainage Black matt lacquer	100287054	161
Valve Black matt lacquer	100287055	130
Accessory 45 cm. Roble Torrefacto	700029961	290
Accessory toallero circular	100136307	117
Mirror 60x48 Sable with light	700019736	699
Tall cabinet 45x144 Sable / Roble Torrefacto	700015249	1084
Column front 45x73 Xtone Nylo Noir Pulido	700031628	584
Tall cabinet 15x144 Sable / Xtone Nylo Noir Pulido	700015268	771
<b>PLAY Xtone Nylo Noir Pulido / Roble Torrefacto</b>		<b>10008</b>

## PLAY



ARTICLE	SAP	POINTS
Basin PLAY XTONE Xtone Liem Grey 120	700031501	5086
Drainage	100242315	255
Valve	100104178	59
Accessory 90 cm. Roble Polvo	700018623	403
Accessory toallero circular x 2 Unds.	100136307	234
MS 90x26 Roble Polvo / Xtone Liem Grey Nature x 2 Unds.	700031564	3584
MA Living 60x26 Roble Polvo x 2 Unds.	700028408	2454
MA Living frente 60x26 Roble Polvo x 2 Unds.	700028530	1172
Mirror 210x26	700028132	361
Mirror 90x26	700028128	217
<b>PLAY Xtone Liem Grey / Roble Polvo</b>		<b>13825</b>

## STAGE



ARTICLE	SAP	POINTS
Wash basin unit 81 Tórtola x 2 Unds.	700031107	10098
Legs Roble Bronce x 2 Unds.	700030904	2092
Mirror 69,5x74,6 Roble Bronce x 2 Unds.	700031105	2100
Basin STAGE KRION 81 x 2 Unds.	100316561	4728
<b>STAGE Tórtola Mate</b>		<b>19018</b>

## UP



ARTICLE	SAP	POINTS
Wash basin unit 60 Alabastro mate	700029742	1763
Profile 60 Alabastro mate	700029890	96
Mirror 60x80 Acero	100035988	317
Basin SLIM 60	100221199	596
Valve	100200010	72
<b>UP Alabastro Mate</b>		<b>2844</b>

## UP



ARTICLE	SAP	POINTS
Wash basin unit 80 Blanco Snow Mate	700029762	1776
Wall-hung module 40 Blanco Snow Mate	700029826	1292
Wall-hung module 40 Blanco Snow Mate	700029830	1427
Profile 160 Blanco Snow Mate	700029890	256
Worktop Krion LAST SOTTO 1361-1660	700027726	1805
Valve	100174610	112
Mirror ICON 90x36 Sable x2	700019731	1504
Accessory-holder shelf Roble Puro 210	700018620	658
Flat Towel Rack Metal x 2	100136308	202
Accessory CICLO ESTANTE C/BOTES	100136306	379
<b>UP Blanco Snow Mate</b>		<b>9411</b>

## UP



ARTICLE	SAP	POINTS
Wash basin unit 80 Roble puro	700029761	2413
Wall-hung module 40 Roble puro	700029829	1914
Profile 120 Roble puro	700029890	240
Mirror 60x80 Acero	100035988	317
Worktop Krion LAST SOTTO 1061-1360	700027725	1545
Valve	100174610	112
Tall cabinet 30X156X30 MSC DX Roble puro	700029873	3230
<b>UP Roble Puro</b>		<b>9771</b>

## BLIND



ARTICLE	SAP	POINTS
Wash basin unit 120 DX Roble Noche	700026300	3584
Leg BPS120 Metal	100243178	429
Basin BLIND Amarula Vintage 120	700026230	3073
Mirror BLIND 150x30 Metal	700026256	931
Mirror BLIND 30x150 Metal	700026227	931
Valve	100104178	59
<b>BLIND Roble Noche</b>		<b>9007</b>

## BLIND



ARTICLE	SAP	POINTS
Wash basin unit 120 DX Roble Cobre x 2Unds.	700026300	7168
Leg BPS120 Metal x 2Unds.	100243178	858
Basin BLIND Barocco Vintage 120 x 2Unds.	700026246	5686
Mirror BLIND 30x150 Metal x 2Unds.	700026227	1862
Valve x 2Unds.	100104178	118
<b>BLIND Roble Cobre</b>		<b>15692</b>

**SIDE**

ARTICLE	SAP	POINTS
Wash basin unit SIDE 60X52X48 BPS 2005 LAC BR	700027780	1479
Worktop FIT C/LAV 605X490 1G GEL COAT	100241712	427
Mirror ESP-290/30 30X90 S/I	100043788	260
Valve CLIC-CLAC C/TORNILLO FIJADOR	100200010	72
<b>SIDE Blanco Emotions Brillo</b>		<b>2238</b>

**SIDE**

ARTICLE	SAP	POINTS
Basin SLIM 805X490 1G GEL COAT x 2Unds.	100221201	1364
Fixings SLIM x 2Unds.	250010391	18
Valve CLIC-CLAC C/TORNILLO FIJADOR x 2Unds.	100200010	144
Drainage MINI DUNA CROMO x 2Unds.	100190984	420
M.B. SIDE 45X26X48 MS 2013 LAC BR x 2Unds.	700027876	1740
M.B. DESS 210 BARRA PORTA-ACC L.BRILLO	700015395	530
Accessory CICLO ESTANTE C/BOTES x 2Unds.	100136306	758
Mirror 90X48X9 C/ILU x 2Unds.	700019737	1546
<b>SIDE Blanco Emotions Brillo</b>		<b>6520</b>

**SIDE**

ARTICLE	SAP	POINTS
M.B. SIDE 60X52X48 MS 2014 MAD	700027905	1768
M.B. SIDE 60X26X48 MS 2013 MAD	700027881	1122
Basin TOMO 180 DX MD KRION	100278789	3174
Drainage SIFON MINI BOT.G-D 32X300 CROM.	100036255	103
Valve CLICK-CLACK C/TOR FIJAD TAPA KRI	100174610	112
Accessory DESS 60X9X12 PORTA-ACC SABLE KR	100160321	214
Accessory DESS BOTE SABLE x 2 Unds.	100157824	112
Accessory DESS 30 BARRA PORTA-ACC ALBA E6	700029942	267
Accessory CICLO TOALLERO CIRCULAR	100136307	117
Mirror S/MEDIDAS C/TRASERA MAD 1800x600 mm	700028111	444
M.B. DESS 30X144X18 MSC-2 SABLE MADERA	700015248	954
M.B. DESS PUERTA 30X73 MSC-2 144 MADERA	700015254	338
M.B. DESS 45X144X18 MSC-2 SABLE MADERA	700015249	1084
M.B. DESS PUERTA 45X73 MSC-2 144 MADERA	700015255	410
<b>SIDE Roble Alba</b>		<b>10219</b>

**SIDE**

ARTICLE	SAP	POINTS
Wash basin unit SIDE 60 BPS LAC MT x 2 Unds.	700028007	3372
LAST 45-60X2X48 PEANA LAC MT x 2 Unds.	700026637	228
Worktop NOVA XLIGHT BOTEGA x 2 Unds.	700023402	1454
Basin SOTTO NOVA 50 UPC x 2 Unds.	100241696	428
Valve CLIC-CLAC x 2 Unds.	100200010	144
Drainage MINI x 2 Unds.	100036255	206
Accessory BARRA PERFIL 60 SABLE x 2 Unds.	100278338	922
Accessory TOALLERO 30 SABLE	100278348	321
Accessory BOTE PORTA-ACCESORIOS SABLE	100157824	56
Mirror C/TRASERA 600x600 x 2 Unds.	700028134	474
<b>SIDE Alabastro Mate</b>		<b>7605</b>

## LAST

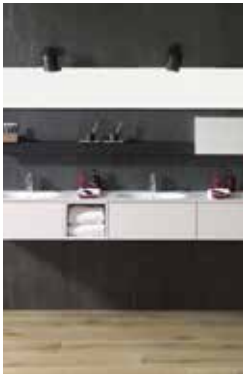

ARTICLE	SAP	POINTS
Wash basin unit 60X26X48 BPS 2002 LAC MT 2 Unds.	700026365	1648
M.B. LAST 15-30X26X48 EST 2020 LAC MT	700031339	753
M.B. LAST 60X26X48 MS 2013 LAC MT 2 Unds.	700026489	1684
Worktop KRION LAST SOTTO C/RE 2261-2710	700027729	2200
Valve CLICK-CLACK C/TOR FIJAD TAPA KRI 2 Unds.	100174610	224
Drainage MINI BOT.G-D 32X300 CROM. 2 Unds.	100036255	206
M.A. LIVING CASCO BLANCO SNOW ABATIBLE 2 Unds.	700028408	1122
M.A. LIVING FRENTE BLANCO SNOW ABATIBLE Unds.	700028530	980
Accessory LAST BARRA PERFIL 150 SABLE	100278331	926
Accessory LAST CEPILLOS 15 ROBLE PURO 2 Unds.	100278340	76
Accessory DESS BOTE SABLE 2 Unds.	100157824	112
Accessory LAST CUBO 15 ROBLE PURO	100278342	63
Mirror S/MEDIDAS RANGO 7 2700x300 mm	700026315	310
Light LAST SABLE 2 Unds.	100278351	390
<b>LAST Blanco Snow Mate</b>		<b>10654</b>

## LAST



ARTICLE	SAP	POINTS
Mirror ESP-310/120 120X60 S/I	100043791	350
Accessory 60X9X12 SABLE	100160321	214
Accessory DESS BOTE SABLE 2 Unds.	100157824	112
Wash basin unit LAST 120X52X48 BPS LAMI BL SNOW	700026408	1262
Worktop KRION STONE 1202X492 TRAVAT/FOLK	100110448	1356
Tall cabinet LAST 30X156 MSC SX BL SNOW 4 Unds.	700031478	3232
Drainage MINI BOT.G-D 32X300 CROM. 2 Unds.	100036255	206
Valve DESCARGA LIBRE 2 Unds.	100036254	136
<b>LAST Blanco Snow Mate</b>		<b>6868</b>

## LAST



ARTICLE	SAP	POINTS
Mirror BLIND 90x45 HORIZONTAL SABLE	700026269	838
Mirror BLIND 45x150 VERTICAL SABLE	700026228	1021
Wash basin unit LAST 100 BPS OCEAN BLUE M	700026401	1470
Basin SOTTO NOVA	100286592	328
Worktop LAST 100 XTONE GLEM WHITE	700023414	1042
Valve CLIC-CLAC C/TORNILLO FIJADOR	100200010	72
Drainage MINI BOT.G-D 32X300 CROM.	100036255	103
<b>LAST Ocean Blue</b>		<b>4874</b>

## SET 0477



ARTICLE	SAP	POINTS
M.B.LAST FSP 100X52X48 BPS 2005 WIND M-L	100279110	1142
Worktop FIT C/LAV 1005X490 1G GEL COAT	100241627	659
Drainage chrome	100036255	103
Valve CLIC-CLAC C/TORNILLO FIJADOR	100200010	72
<b>SET 0477 LAST Wind</b>	<b>100254958</b>	<b>1976</b>



## MERTENS



ARTICLE	SAP	POINTS
Wash basin unit 132 cm. Roble Puro	700023508	1534
Basin MERTENS 132 Cristal Taupe 1G	100221189	1986
Mirror 120x60 cm.	700026285	293
Wallmounted unit 120 cm. Roble Puro	700023515	3820
Accessory-holder shelf Roble Puro 60	700018622	320
Flat Towel Rack Metal x 2	100136308	202
Accessory-holder shelf Metal / Inox 60 x 2	100160321	428
Pot x 6 unds.	100157824	336
Drainage chrome	100190984	210
<b>MERTENS Roble Puro</b>		<b>9129</b>

## DUNA



ARTICLE	SAP	POINTS
Wash basin unit 120 cm. Metal	100190985	1655
Basin DUNA PORTOBELLO	700019859	2600
Mirror 61x61 cm. Metal	700019702	1098
Shelf	700019703	154
Wallmounted unit 120 cm. Roble Noche	700019706	2566
Drainage	100190984	210
<b>DUNA Roble Noche</b>		<b>8283</b>

## CENTURY



ARTICLE	SAP	POINTS
Wash basin unit 94 cm. Roble Polvo	700019860	2772
Worktop 94 cm. Mármol Carrara	700002508	722
Basin sotto box	100036217	260
Mirror 48x90	100274378	262
<b>CENTURY Roble Polvo</b>		<b>4016</b>

## EDGE



ARTICLE	SAP	POINTS
Wash basin unit 90 cm. Roble Cuero	700019845	3767
Basin EDGE 86 cm. CHEYENNE	700023594	2632
Mirror 90x48 Metal	700019842	354
<b>EDGE Roble Cuero</b>		<b>6753</b>



## ICON



ARTICLE	SAP	POINTS
Wash basin unit 60 cm. Roble Carbón	700018706	2376
Basin ICON 60 CHEYENNE	700018750	2852
Mirror 90x36 cm. Metal	100138792	260
Accessory-holder shelf 45	100176532	190
Pot x 3 unds.	100157824	168
<b>ICON Roble Carbón</b>		<b>5846</b>

## ICON



ARTICLE	SAP	POINTS
Wash basin unit 90 cm. Roble Carbón	700018704	1385
Wallmounted unit 90 cm. Roble Carbón	700018711	2773
Basin ICON 90 CHEYENNE	700018741	3406
Mirror 90x36 cm. Metal	100138792	260
Accessory-holder shelf 45	100176532	190
Pot x 3 unds.	100157824	168
<b>ICON Roble Carbón</b>		<b>8182</b>

## ICON



ARTICLE	SAP	POINTS
Wash basin unit 120 cm. Roble Polvo	700018702	1997
Basin ICON 120 CHEYENNE	700018739	3965
Mirror 120x48 cm. Metal	100138775	344
Accessory-holder shelf 45	100176532	190
Pot x 3 unds.	100157824	168
<b>ICON Roble Polvo</b>		<b>6664</b>

## SET 0322



ARTICLE	SAP	POINTS
Wash basin unit SX 90 cm. Blanco Snow Mate	100176465	1488
Worktop SX LEAF KRION 90 cm.	100173957	1470
Mirror 90x36 cm. Metal	100160323	268
Shelf 45 cm. Metal	100176532	190
Accessory Negro Metal x3 Unds.	100157824	168
Valve	100174610	112
<b>SET 0322 LEAF Blanco Snow Mate</b>	<b>100176394</b>	<b>3696</b>



## SET 0417



ARTICLE	SAP	POINTS
Wash basin unit 90 cm. Noche Ghost	100210828	2134
Mirror 90x48 cm. Metal	100138793	291
Shelf 45 cm. Metal	100176532	190
Accessory Negro Metal x3 Unds.	100157824	168
<b>SET 0417</b> <b>SOFT Noche Ghost</b>	<b>100222333</b>	<b>2783</b>

## SOFT



ARTICLE	SAP	POINTS
Wash basin unit 120 cm. Gris Carbono Ghost	700015853	1926
Mirror 120x36 cm.	700026294	340
Basin ONES 115 cm.	100100507	1202
<b>SOFT Gris Carbono Ghost</b>		<b>3468</b>

## SOFT



ARTICLE	SAP	POINTS
Wash basin unit 90 cm. Negro Ghost	700015872	1740
Lower unit 90 cm. Negro Ghost	700015848	1232
Mirror 90x36 cm.	700026303	241
<b>SOFT Negro Ghost</b>		<b>3213</b>

## DESS



ARTICLE	SAP	POINTS
Wash basin unit 60 cm. Borax B. DX 2U.	700015124	3568
Lower unit 60 cm. Borax B. SX 2Unds.	700015135	3896
Basin DESS 60 GEL COAT 2 Unds.	100221191	938
Accessory 60 cm. 2 Unds.	100160321	428
Accessory Bote 6 Unds.	100157824	336
Accessory 120 cm. Roble Bronce	700015385	444
Accessory 2 Unds.	100136307	234
Mirror 120x36x9 cm. Metal 2 Unds.	700015221	718
<b>DESS Borax Brillo / Roble Bronce</b>		<b>10562</b>

## SET 0472



ARTICLE	SAP	POINTS
Wash basin unit 90 cm. R. Torrefacto	100160322	2245
Basin DESS 90 cm.	100221193	561
Mirror 90x36 cm. Negro Metal	100160323	268
Shelf 60 cm. Negro Metal	100160321	214
Accessory Negro Metal x3 Unds.	100157824	168
Valve	100036254	68
Drainage	100138072	40
<b>SET 0472      DESS Roble Torrefacto</b>	<b>100243222</b>	<b>3564</b>

## SET 0473



ARTICLE	SAP	POINTS
Wash basin unit 90 cm. Roble Noche	100176475	2245
Mirror 90x36 cm. Metal	100160323	268
Basin DESS 90 cm.	100221193	561
<b>SET 0473      DESS Roble Noche</b>	<b>100243927</b>	<b>3074</b>

## DESS



ARTICLE	SAP	POINTS
Wash basin unit 120 cm. Limo Brillo	700015108	2271
Basin DESS 120 cm.	100221195	675
Mirror 120x36 cm.	700026294	340
Valve	100036254	68
Drainage	100138072	40
<b>DESS Limo Brillo</b>		<b>3394</b>

## CICLO



ARTICLE	SAP	POINTS
Wash basin unit 95 cm. Blanco Mate Emotions	700011040	1623
Wash basin unit 90 cm. Blanco Mate Emotions	700011028	1515
Lower unit 95 cm. Blanco Mate Emotions	700011049	1560
Worktop KRION LUX 270 cm.	700009524	2651
Valve	100036254	68
Mini drain	100036255	103
Mirror 180x36 cm.	100138778	407
Accessory-holder rod 180	700010983	452
Accessory 2 Unds.	100136305	362
Accessory	100136306	379
<b>CICLO Blanco Mate Emotions</b>		<b>9120</b>

## SET 0350



ARTICLE	SAP	POINTS
Wash basin unit 100 cm. Blanco Brillo EM	100190258	2020
Worktop Blanco Brillo EM	100190248	467
Mirror 90x48 cm.	100138793	291
Basin CICLO 70 GEL COAT	100128501	736
Drainage	100138072	40
<b>SET 0350</b> CICLO Blanco B. / Enc. B. Brillo / Lav.70	<b>100193158</b>	<b>3554</b>

## CICLO



ARTICLE	SAP	POINTS
Wash basin unit 95 cm. Pérgamon Mate DX	700011040	1623
Wash basin unit 95 cm. Pérgamon Mate SX	700011043	1623
Drawer 30 cm. Pérgamon Mate	700010992	798
Worktop Pérgamon Mate 210 cm.	700011082	651
Basin CICLO 70 2 Unds.	100128501	1472
Mirror 120x36 cm.	100138774	305
Mirror 150x36 cm.	100138776	356
Accessory-holder rod 120	700010947	351
Accessory-holder rod 150	700010980	399
Accessory	100136305	181
Accessory	100136306	379
Shelf DX 5 Unds.	700011052	2260
Shelf SX 5 Unds.	700011055	2260
<b>CICLO Pérgamon Mate</b>		<b>12658</b>

## CICLO



ARTICLE	SAP	POINTS
Wash basin unit 100 cm. Grafito Mate	700010941	1751
Worktop CICLO 76'1-106x1'9x50 cm. Grafito Mate	700011085	337
Mirror 90x48 cm.	100138793	291
Basin CICLO 70 GEL COAT	100128501	736
Drainage	100138072	40
<b>CICLO Grafito Mate</b>		<b>3155</b>

## IN



ARTICLE	SAP	POINTS
Wash basin unit M.B. IN 120 BPS-1 ROBLE	700007232	2327
Lower unit M.B. IN 120 MS-1 ROBLE	700007271	2332
Basin ONES 115 D/S GEL COAT	100100507	1202
Mirror 120X63 S/ILU	700026273	347
Mirror 60X32 S/ILU	700026305	208
Accessory DESS 60 BARRA PORTA-ACC MADERA	700015383	313
Accessory CICLO ESTANTE C/BOTES	100136306	379
Tall cabinet M.B. IN 30X156 MA-H DX ROBLE 2 Unds.	700013838	5094
Drainage TUBO CORRUGADO DIAM. 32	100100505	281
<b>IN Roble Noche</b>		<b>12483</b>

## SET 0471



ARTICLE	SAP	POINTS
Wash basin unit 120 cm. Blanco Brillo EM	100241382	1858
Basin ONES 115 cm.	100100507	1202
<b>SET 0471 IN Blanco Brillo EM + ONES 115</b>	<b>100241551</b>	<b>3060</b>

## SET 0348



ARTICLE	SAP	POINTS
Wash basin unit 90 cm. Blanco Brillo EM	100190249	2101
Basin ONES 71,5 cm.	100100508	982
Mirror 90x60 cm. S/I	100043790	260
<b>SET 0348 IN Blanco Brillo EM</b>	<b>100193172</b>	<b>3343</b>

## IN



ARTICLE	SAP	POINTS
Wash basin unit 120 cm. Pizarra Mate	700007235	1766
Lower unit 60 cm. Pizarra Mate	700007272	1314
Mirror 36x90	100274407	237
Basin ONES 115 cm.	100100507	1202
<b>IN Pizarra Mate</b>		<b>4519</b>

**SET CORNER**

ARTICLE	SAP	POINTS
Wash basin unit CORNER 120 BPS Nogal Frost	100292658	1329
Mirror CORNER 92x62x16,8 Nogal Frost	100292730	728
Basin FIT 120 GELCOAT	100241693	794
Valve CLIC-CLAC C/TORNILLO FIJADOR	100200010	72
<b>SET CORNER Nogal Frost</b>		<b>2923</b>

**SET CORNER**

ARTICLE	SAP	POINTS
Wash basin unit CORNER 80 BPS Nogal Moon	100292706	1016
Mirror CORNER 47x62x16,8 Nogal Moon	100292659	577
Basin SLIM APOYO 80 GEL COAT	100221201	682
Valve CLIC-CLAC C/TORNILLO FIJADOR	100200010	72
<b>SET CORNER Nogal Moon</b>		<b>2347</b>

**SET FASE**

ARTICLE	SAP	POINTS
Wash basin unit FASE 80 BPS SUGI BLACK	100278399	1022
Mirror ESP-290/30 30X90 S/I	100043788	260
Basin FASE 80 CERAMICA	100278366	260
<b>SET FASE Sugi Black</b>		<b>1542</b>

**SET RADIO**

ARTICLE	SAP	POINTS
Wash basin unit RADIO 60 BPS OLMO LIGHT	100278406	950
Mirror RADIO 55X55	100278362	223
Worktop KRION RADIO 60	100278353	904
Valve	100174610	112
<b>SET RADIO Olmo Light</b>		<b>2189</b>

## SET GAP



ARTICLE	SAP	POINTS
Wash basin unit GAP 60 Sable x 2 Unds.	100278402	1030
Basin SLIM APOYO 605X490 1G GEL COAT x 2 Unds.	100221199	1192
Valve CLIC-CLAC C/TORNILLO FIJADOR x 2 Unds.	100200010	144
Drainage MINI BOT.G-D 32X300 CROM. x 2 Unds.	100036255	206
Accessory DESS 60X9X12 SABLE KR x 2 Unds.	100160321	428
Accessory DESS BOTE SABLE x 4 Unds.	100157824	224
Accessory DESS 30 BARRA ROBLE NOCHE	700029942	267
Accessory DESS TOALLERO CIRCULAR	100136307	117
Mirror 60X48X9 SABLE C/ILU x 2 Unds.	700019736	1398
<b>GAP Sable</b>		<b>5006</b>

## SET GAP



ARTICLE	SAP	POINTS
Wash basin unit GAP 90 Sable	100278403	536
Basin SLIM APOYO 905X490 1G GEL COAT	100221203	765
Valve CLIC-CLAC C/TORNILLO FIJADOR	100200010	72
Drainage MINI BOT.G-D 32X300 CROM.	100036255	103
Mirror CICLO 90x48 cm.	100138793	291
<b>GAP Sable</b>		<b>1767</b>

## SET SKILL



ARTICLE	SAP	POINTS
Wash basin unit 90 Blanco Brillo	100242180	1101
Basin DESS 1G GEL COAT 90	100221193	561
Mirror SKILL 90 Blanco Brillo	100242182	231
Valve	100104178	59
<b>SET SKILL Blanco Brillo</b>		<b>1952</b>

## SET HEM



ARTICLE	SAP	POINTS
Wash basin unit 120 cm. Sugi Black	100243618	1220
Worktop FIT GELCOAT 120	100241693	794
Mirror HEM 120x42 cm. Sugi Black	100243577	385
<b>SET HEM Sugi Black</b>		<b>2399</b>

## SET HEM



ARTICLE	SAP	POINTS
Wash basin unit 60 cm. Sugi Black	100243584	900
Worktop FIT GELCOAT 60	100241712	427
Mirror HEM 80x42 cm. Sugi Black	100243598	343
Tall cabinet 30x144 Sugi Black	100243620	938
SET HEM Sugi Black		2608

## SET TUCK



ARTICLE	SAP	POINTS
Wash basin unit 120 cm. Fresno Cendra	100222278	1516
Basin SLIM GELCOAT 120 1G	100221205	822
Mirror Tuck 120x60 Fresno Cendra	100222294	553
Valve	100200010	72
SET TUCK Fresno Cendra		2963

## SET NUT



ARTICLE	SAP	POINTS
Wash basin unit 49x50 Roble Carbón	100314883	511
Worktop GELCOAT 50,4	100144923	397
Mirror Nut 40x70 Roble Carbón	100314857	236
NUT Roble Carbón		1144

## SET BAMBU



ARTICLE	SAP	POINTS
Wash basin unit 60 cm. Blanco Brillo	100208438	1005
Worktop 60,5 cm. Cristal blanco	100173921	704
Mirror 55x60	100112922	143
SET BAMBU Blanco brillo		1852



**SET BAMBU**

ARTICLE	SAP	POINTS
Wash basin unit 80,5 cm. Gris sombra	100208468	1074
Basin 80 cm. Gelcoat	100172916	522
Mirror 75x60	100112923	187
<b>SET BAMBU Gris sombra</b>		<b>1783</b>

**SET URBAN**

ARTICLE	SAP	POINTS
Wash basin unit 60 cm. L. Roble Root	100304638	627
Basin 60,5 cm. Gelcoat	100160956	560
Mirror 60x60 Laminado Roble Root	100304634	145
<b>SET URBAN N Laminado roble root</b>		<b>1332</b>

**SET URBAN**

ARTICLE	SAP	POINTS
Wash basin unit 120 cm. L. Roble Root	100304625	1091
Basin 120,5 cm. Gelcoat	100171860	981
Mirror 120x60 Laminado Roble Root	100304603	304
<b>SET URBAN N Laminado roble root</b>		<b>2376</b>

**SET FOLK**

ARTICLE	SAP	POINTS
Wash basin unit 80 cm. Lino / Ice	100210805	1065
Worktop KRION STONE 80	100091018	660
Mirror Lino 65x60	100091020	198
<b>SET FOLK Lino / Ice</b>		<b>1923</b>

## SET TRAVAT



ARTICLE	SAP	POINTS
Wash basin unit 80 cm. Fume	100091032	1075
Basin 80 krion STONE	100091018	660
Mirror 65x60 Fume	100091022	216
SET TRAVAT Fume		1951

## SET TRAVAT



ARTICLE	SAP	POINTS
Wash basin unit 80 cm. Camel	100091033	1290
Basin 80 krion STONE	100091018	660
Mirror 65x60 Camel	100091021	216
Tall cabinet 30x160 Camel	100095697	924
SET TRAVAT Camel		3090

## SET DOCK



ARTICLE	SAP	POINTS
Wash basin unit 60 cm. Roble Carbón	100314858	491
Basin 60,5 cm. GELCOAT	100160956	560
Mirror 60x60 Roble Carbón	100314870	175
SET DOCK Roble Carbón		1226







## accessories

Mirrors Specchi Зеркала	398
Lights Lampade Лампы	402
Accessories Accessori Аксессуары	404
Valves Valvole Клапаны	408

## ESP-MARCO



- Mirror with steel frame.
- Specchio con cornice in acciaio
- Зеркало в стальной раме.

MEASURES	(↔x↕□x↗)	SAP	POINTS
45x90x3 / 17 <sup>3/4</sup> x35 <sup>3/8</sup> x1 <sup>1/8</sup>		100035985	308
60x80x3 / 23 <sup>5/8</sup> x31 <sup>1/2</sup> x1 <sup>1/8</sup>		100035988	317

## ESP-140/140 / ESP-140/120 / ESP-140/100 / ESP-140/70



- Mirror.
- Specchio
- Зеркало.

MEASURES	(↔x↕□x↗)	SAP	POINTS
140x70x3 / 55 <sup>1/8</sup> x27 <sup>1/2</sup> x1 <sup>1/8</sup>		100274386	425
120x70x3 / 47 <sup>1/4</sup> x27 <sup>1/2</sup> x1 <sup>1/8</sup>		100274416	370
100x70x3 / 39 <sup>3/8</sup> x27 <sup>1/2</sup> x1 <sup>1/8</sup>		100274377	318
70x70x3 / 27 <sup>1/2</sup> x27 <sup>1/2</sup> x1 <sup>1/8</sup>		100035991	235

## ESP-290/30



- Mirror.
- Specchio
- Зеркало.

MEASURES	(↔x↕□x↗)	SAP	POINTS
30x90x3 / 11 <sup>3/4</sup> x35 <sup>3/8</sup> x1 <sup>1/8</sup>		100043788	260

## ESP-310/90 / ESP-310/110 / ESP-310/120



- Mirror.
- Specchio
- Зеркало.

MEASURES	(↔x↕□x↗)	SAP	POINTS
90x60x3 / 35 <sup>3/8</sup> x23 <sup>5/8</sup> x1 <sup>1/8</sup>		100043790	260
110x60x3 / 43 <sup>1/4</sup> x23 <sup>5/8</sup> x1 <sup>1/8</sup>		100043789	318
120x60x3 / 47 <sup>1/4</sup> x23 <sup>5/8</sup> x1 <sup>1/8</sup>		100043791	350



-Mirror.  
-Specchio  
-Зеркало.

MEASURES	(↔x↑□x↙)	SAP	POINTS
40x80x2 / 15 <sup>3/4</sup> x31 <sup>1/2</sup> x0 <sup>3/4</sup>		100069508	190
36x90x2 / 14 <sup>1/8</sup> x35 <sup>3/8</sup> x0 <sup>3/4</sup>		100274407	237
48x90x2 / 18 <sup>7/8</sup> x35 <sup>3/8</sup> x0 <sup>3/4</sup>		100274378	262
36x80x2 / 14 <sup>1/8</sup> x31 <sup>1/2</sup> x0 <sup>3/4</sup>		100274398	231
60x48x2 / 23 <sup>5/8</sup> x18 <sup>7/8</sup> x0 <sup>3/4</sup>		100274421	221
90x48x2 / 35 <sup>3/8</sup> x18 <sup>7/8</sup> x0 <sup>3/4</sup>		100274440	262
120x48x2 / 47 <sup>1/4</sup> x18 <sup>7/8</sup> x0 <sup>3/4</sup>		100274397	318

**CUSTOM MIRROR**

-Mirror.  
-Specchio  
-Зеркало.

ESP-RANGO		↔						
		15-30 cm. 5 <sup>7/8</sup> -11 <sup>3/4</sup>	30,1-60 cm. 11 <sup>7/8</sup> -23 <sup>5/8</sup>	60,1-90 cm. 23 <sup>5/8</sup> -35 <sup>3/8</sup>	90,1-120 cm. 35 <sup>1/2</sup> -47 <sup>1/4</sup>	120,1-150 cm. 47 <sup>1/4</sup> -59	150,1-180 cm. 59 <sup>1/8</sup> -70 <sup>7/8</sup>	180,1-210 cm. 70 <sup>7/8</sup> -82 <sup>5/8</sup>
↑□	15-30 cm. 5 <sup>7/8</sup> -11 <sup>3/4</sup>	SAP 700026272 164 P.	SAP 700026312 177 P.	SAP 700026275 189 P.	SAP 700026276 222 P.	SAP 700026293 251 P.	SAP 700026320 283 P.	SAP 700026315 310 P.
	30,1-60 cm. 11 <sup>7/8</sup> -23 <sup>5/8</sup>	SAP 700026304 182 P.	SAP 700026305 208 P.	SAP 700026303 241 P.	SAP 700026285 293 P.	SAP 700026294 340 P.	SAP 700026306 378 P.	SAP 700026277 422 P.
	60,1-90 cm. 23 <sup>5/8</sup> -35 <sup>3/8</sup>	SAP 700026307 195 P.	SAP 700026278 241 P.	SAP 700026279 285 P.	SAP 700026273 347 P.	SAP 700026237 414 P.	SAP 700026238 484 P.	SAP 700026282 539 P.
	90,1-120 cm. 35 <sup>1/2</sup> -47 <sup>1/4</sup>	SAP 700026313 218 P.	SAP 700026283 282 P.	SAP 700026314 337 P.	SAP 700026284 418 P.	SAP 700026302 514 P.	SAP 700026274 675 P.	SAP 700026239 754 P.

**CUSTOM BACK PANEL NADIR WOOD MIRROR**

-Custom back panel NADIR wood mirror. **Compatible with SIDE / LAST accessory bar.**  
-Specchio di legno NADIR. **Compatibile con la barra degli accessori SIDE / LAST.**  
-Зеркало на деревянной панели. **Совместима с полкой для аксессуаров SIDE/LAST.**

ESP-RANGO		↔						
		15-30 cm. 5 <sup>7/8</sup> -11 <sup>3/4</sup>	30,1-60 cm. 11 <sup>7/8</sup> -23 <sup>5/8</sup>	60,1-90 cm. 23 <sup>5/8</sup> -35 <sup>3/8</sup>	90,1-120 cm. 35 <sup>1/2</sup> -47 <sup>1/4</sup>	120,1-150 cm. 47 <sup>1/4</sup> -59	150,1-180 cm. 59 <sup>1/8</sup> -70 <sup>7/8</sup>	180,1-210 cm. 70 <sup>7/8</sup> -82 <sup>5/8</sup>
↑□	15-30 cm. 5 <sup>7/8</sup> -11 <sup>3/4</sup>	SAP 700028107 180 P.	SAP 700028118 199 P.	SAP 700028128 217 P.	SAP 700028129 260 P.	SAP 700028130 284 P.	SAP 700028131 323 P.	SAP 700028132 361 P.
	30,1-60 cm. 11 <sup>7/8</sup> -23 <sup>5/8</sup>	SAP 700028133 199 P.	SAP 700028134 237 P.	SAP 700028108 283 P.	SAP 700028109 348 P.	SAP 700028110 393 P.	SAP 700028111 444 P.	SAP 700028112 495 P.
	60,1-90 cm. 23 <sup>5/8</sup> -35 <sup>3/8</sup>	SAP 700028113 217 P.	SAP 700028114 283 P.	SAP 700028115 344 P.	SAP 700028116 420 P.	SAP 700028117 490 P.	SAP 700028119 578 P.	SAP 700028120 650 P.
	90,1-120 cm. 35 <sup>1/2</sup> -47 <sup>1/4</sup>	SAP 700028121 238 P.	SAP 700028122 327 P.	SAP 700028123 404 P.	SAP 700028124 500 P.	SAP 700028125 603 P.	SAP 700028126 786 P.	SAP 700028127 883 P.

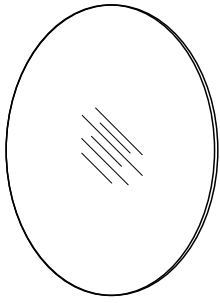

- Mirror. **Compatible with SIDE / LAST accessory bar.**
- Specchio. **Compatibile con la barra degli accessori SIDE / LAST.**
- Зеркало на деревянной панелию. **Совместима с полкой для аксессуаров SIDE/LAST.**

## MEASURES



SAP

POINTS

90x90X2 / 35<sup>3/8</sup>x35<sup>3/8</sup>x0<sup>3/4</sup>

700028082

432







With transformer.  
Led circuit 1x6W  
IP-44

Con trasformador.  
Circuito led 1x6W.  
IP-44

С трансформатором.  
Светодиодная цепь 1x6 Вт  
IP-44



Limited stock, check availability.

Scorte limitate, si prega di verificare la disponibilità.

Ограниченный складской запас, запросите наличие.

MEASURES		FINISHES	SAP	POINTS
2,6x29x9,1 / 1x11 <sup>3/8</sup> x3 <sup>5/8</sup>		CHROME	100217594	125

## NEW CHIC IP44



220-240V  
LED 6W  
IP-44

MEASURES		FINISHES	SAP	POINTS
23x6x9 / 9x2 <sup>3/8</sup> x3 <sup>1/2</sup>		CHROME	100229861	042

## LIGHT



MEASURES		FINISHES	SAP	POINTS
11,7x21,8x14,4 / 4 <sup>5/8</sup> x8 <sup>5/8</sup> x5 <sup>5/8</sup>		Metal. 220V. E27 <b>(Bulb not included).</b>	100278351	0195



## ACCESSORY A

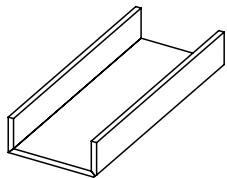

-Divider base.  
-Base organizer  
Основа-разделитель.

MEASURES	(  )	FINISHES	SAP	POINTS
<b>A</b> 15x6x37,5 / 5 <sup>7/8</sup> x2 <sup>3/8</sup> x14 <sup>3/4</sup>		WOOD	100278349	0065

## ACCESSORY B

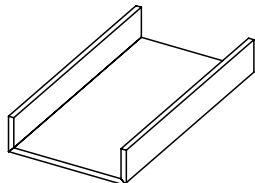

-Divider base.  
-Base organizer  
Основа-разделитель.

MEASURES	(  )	FINISHES	SAP	POINTS
<b>B</b> 20x6x37,5 / 7 <sup>7/8</sup> x2 <sup>3/8</sup> x14 <sup>3/4</sup>		WOOD	100278350	0069

## ACCESSORY C

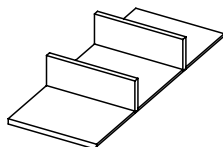

-Divider base.  
-Base organizer  
Основа-разделитель.

MEASURES	(  )	FINISHES	SAP	POINTS
<b>C</b> 15x6x37,5 / 5 <sup>7/8</sup> x2 <sup>3/8</sup> x14 <sup>3/4</sup>		WOOD	100278307	0048

## ACCESSORY D

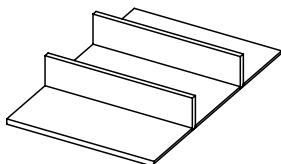

-Divider base.  
-Base organizer  
Основа-разделитель.

MEASURES	(  )	FINISHES	SAP	POINTS
<b>D</b> 25x6x37,5 / 9 <sup>7/8</sup> x2 <sup>3/8</sup> x14 <sup>3/4</sup>		WOOD	100278308	0057

## ACCESSORY E

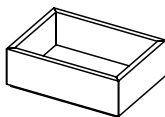

-Container compatible with A, B and D.  
-Contentitore compatibile con A, B e D.  
-Контейнер совместим с А, В и D.

MEASURES	(  )	FINISHES	SAP	POINTS
<b>E</b> 19x6x13,9 / 7 <sup>1/2</sup> x2 <sup>3/8</sup> x5 <sup>1/2</sup>		WOOD	100278305	0090

## ACCESSORY F

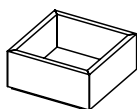

-Container compatible with A, C and D.  
-Contentitore compatibile con A, C e D.  
-Контейнер совместим с А, С и D.

MEASURES	(  )	FINISHES	SAP	POINTS
<b>F</b> 13,9x6x13,9 / 5 <sup>1/2</sup> x2 <sup>3/8</sup> x5 <sup>1/2</sup>		WOOD	100278306	0086

**SET OF ACCESSORIES FOR BPS.  
UP / LAST / SIDE**

DRAW. 600	DRAW. 800	DRAW. 900	DRAW. 1000	DRAW. 1200
 SET. 512	 SET. 513	 SET. 514	 SET. 515	 SET. 516
				 SET. 517
				 SET. 518
				 SET. 519

SET	FINISHES	SAP	POINTS
512		100278236	0113
513		100278271	0114
514		100278248	0226
515		100278227	0268
516	WOOD	100278272	0252
517		100278238	0234
518		100278284	0321
519		100278300	0304

**SET OF ACCESSORIES FOR MS.  
UP / LAST / SIDE**

DRAW. 450	DRAW. 600	DRAW. 800	DRAW. 900	DRAW. 1000	DRAW. 1200
 SET. 520	 SET. 521	 SET. 522	 SET. 524	 SET. 526	 SET. 528
		 SET. 523	 SET. 525	 SET. 527	

SET	FINISHES	SAP	POINTS
520		100278276	0117
521		100278256	0182
522		100278246	0138
523		100278261	0183
524	WOOD	100278257	0295
525		100278258	0261
526		100278262	0304
527		100278270	0322
528		100278263	0408

## ACCESSORY C/D/E

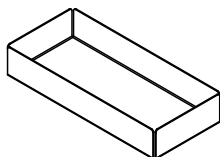

-Container.  
-Contentitore.  
-Контейнер.

MEASURES	FINISHES	SAP	POINTS
<b>C</b> 17x6,5x9 / 6 <sup>3/4</sup> x2 <sup>1/2</sup> x3 <sup>1/2</sup>	ALUMINIO BLANCO	100115480	050
<b>D</b> 17x6,5x17 / 6 <sup>3/4</sup> x2 <sup>1/2</sup> x6 <sup>3/4</sup>		100115478	057

## ACCESSORY F/G/H

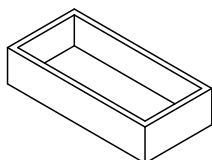

-Container.  
-Contentitore.  
-Контейнер.

MEASURES	FINISHES	SAP	POINTS
<b>G</b> 17x8x17 / 6 <sup>3/4</sup> x3 <sup>1/8</sup> x6 <sup>3/4</sup>	ALUMINIO BLANCO	100100502	0043
<b>H</b> 17x8x35 / 6 <sup>3/4</sup> x3 <sup>1/8</sup> x13 <sup>3/4</sup>		100100501	0055

## ACCESSORY J

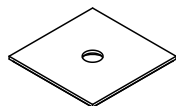

-Container pan.  
-Coperchio contenitore.  
-Поддон контейнера.

MEASURES	FINISHES	SAP	POINTS
17x1,3x17 / 6 <sup>3/4</sup> x0 <sup>1/2</sup> x6 <sup>3/4</sup>	ROBLE	100115485	023

## SET OF ACCESSORIES FOR DRAWER. LEAF / CICLO / DESS / ICON / EDGE / CENTURY / DUNA / MERTENS

DRAWER	60 cm.	90 cm.	120 cm.
<b>D</b>	 H+D+D	 D+D+H+H	 D+D+H+H+H+H+G+G+J+J
<b>E</b>	 H+H+C+C+D		 D+D+H+H
<b>F</b>	 G+G+J+J+C+C+C+C+H		 D+D+D+D+H+H+H+H

SET	FINISHES	SAP	POINTS
D-60	ROBLE / BLANCO	100138794	169
D-90		100138795	224
D-120		100138743	466
E-60		100138744	267
E-120		100138746	224
F-60		100138747	387
F-120		100138749	448

## ACCESSORY



-Buton for plasterboard walls.

-Tassello per cartongesso















MEASURES	(  )	FINISHES	SAP	POINTS
M5 x 50 mm.		50 UNDS.	700002564	199

## VALVES

NOTE: Only orientative chart for recommended plumbing pieces. These pieces depend on the combination of furniture unit, worktop, basin and selected faucet, which could already incorporate same or similar components.

NOTA: Tabella esclusivamente orientativa dei componenti di scarico consigliati. Dipendono dall'abbinamento del mobile, del top, del lavabo e dalla rubinetteria prescelta nella quale potrebbero essere già inseriti gli stessi componenti o altri simili.

ПРИМЕЧАНИЕ: Размер рекомендуемых компонентов слива является ориентировочным. Они зависят от выбранной комбинации мебели, столешницы, умывальной раковины и смесителя. Эта комбинация может включать те же компоненты или аналогичные.

	Valves /	Valvole /	Клапаны	Overflow Troppopieno Перелив	Drains /	Scarichi /	Сливы			
Basins/ worktops Lavabi/top Умывальные раковины / столешницы										
	100036254 68 p	100200010 72 p			100036255 103 p		100190984 210 p			
										
	100242351 106 p	100104178 59 p	100287055 130 p	100174610 112 p	100126944 32 p	100287054 161 p	100100505 281 p	100138072 40 p	100150474 30 p	100242315 255 p
Duna		✓								✓
Icon	✓									
Leaf										✓
Dess		✓						✓		
Soft (undermount)		✓						✓		
Ones	included /	incluso /	включено			3		✓		
Ciclo		✓				3		✓		
Sotto Box			✓		1					
Integ. Krypton®	✓				1				2	
Integ. Krypton® + overflow				✓	1					
Krypton® thermoformed				✓	1					
Gelcoat worktop			✓		1					
Krypton® worktop	✓					✓				
Krypton® worktop + overflow				✓	1					
Way			✓		✓					
Fase			✓		✓					
Spoon / Nut			✓		✓					
Radio				✓	✓					
Mertens	✓									✓
Edge	✓				✓					
Slim / Glass worktop			✓		✓					
Slim (overmount)	✓				✓					
Sotto Nova			✓		1					
Fit			✓		✓					
Blind		✓			✓					
Stage				✓	✓					
Play		✓			✓					

✓ -Recommended pieces (some of these pieces can be supplied with the faucet).  
-Componenti consigliati (alcuni di questi componenti possono essere forniti con il rubinetto).  
- Рекомендуемые компоненты (некоторые из них могут поставляться со смесителем).

1 -Recommended pieces when sink unit height is more than 24 cm.  
-Componenti consigliati quando l'altezza del portalavabo è superiore a 24 cm.  
- Компоненты, рекомендуемые в том случае, когда высота консоли/тумбы для умывальной раковины превышает 24 см.

2 -Recommended pieces when sink unit height is less than 24 cm.  
-Componenti consigliati quando l'altezza del portalavabo è inferiore a 24 cm.  
- Компоненты, рекомендуемые в том случае, когда высота консоли/тумбы для умывальной раковины не превышает 24 см.

3 -Recommended pieces when the basin is used with IN sink units.  
-Componenti consigliati quando il lavabo si utilizza con portalavabo IN.  
- Компоненты, рекомендуемые в том случае, когда умывальная раковина используется с консолью/тумбой IN.



## CLIK CLACK POP UP WASTE WITH OVERFLOW



- Clik clack pop up waste with overflow H.75 mm.
- Valvola click-clack con troppopieno H.75 mm.
- Защелкивающийся донный клапан без перелива H.75 мм.

SAP	POINTS
100036228	96

## POP UP WASTE



- Pop up waste without overflow permanent evacuation H.75 mm.
- Valvola senza troppopieno ad evacuazione permanente H.75 mm.
- Донный клапан без перелива для постоянного отвода H.75 мм.

SAP	POINTS
100036229	93

## VALVE



- Clik-clack valve for sinks/basins with and without overflow.
- Valvola clik-clack per lavabi con et senza troppopieno.
- Донный клапан clik-clack для раковин с/без сливом-переливом.

FINISHES	SAP	POINTS
Chrome	100200010	72

## VALVE



- Clik-clack valve for sinks/basins with and without overflow.
- Valvola clik-clack per lavabi con et senza troppopieno.
- Донный клапан clik-clack для раковин с/без сливом-переливом.

FINISHES	SAP	POINTS
Black matt lacquer	100287055	130

## CLIK CLACK POP UP WASTE KRION



- Clik-clack valve for sinks/basins with and without overflow. KRION.
- Valvola clik-clack per lavabi con et senza troppopieno. KRION.
- Донный клапан clik-clack для раковин с/без сливом-переливом. KRION.

SAP	POINTS
100174610	112

## OVERFLOW



- Automatic waste with overflow H.75 mm.
- Boccola di scarico con troppopieno H.75 mm.
- Автоматический клапан с переливом H.75 мм.

SAP	POINTS
100036230	21

## PERMANENT VALVE EVACUATION



- Permanent valve evacuation with cover.
- Valvola semplice a caduta libera con tappo.
- Постоянный перелив с крышкой.

FINISHES	SAP	POINTS
Chrome	100036254	68

## PERMANENT VALVE EVACUATION



- Permanent valve evacuation with cover.
- Valvola semplice a caduta libera con tappo.
- Постоянный перелив с крышкой.

FINISHES	SAP	POINTS
Black matt lacquer	100242351	106

## PERMANENT VALVE EVACUATION



- Permanent valve evacuation.
- Valvola semplice a caduta libera.
- Постоянный перелив.

SAP	POINTS
100104178	59

## OVERFLOW



- Overflow.
- Troppopieno.
- Перелив.

SAP	POINTS
100126944	32

## DESG.300



- Drainage chrome.
- Scarico cromato.
- Дренаж хромированный.

FINISHES	SAP	POINTS
Chrome	100036251	28

## DESG.300 LINEA



- Drainage.
- Scarico.
- Дренаж.

FINISHES	SAP	POINTS
Chrome	100036252	113

## DESG.300 MINI



- Drainage.
- Scarico.
- Дренаж.

FINISHES	SAP	POINTS
Chrome	100036255	103

## DESG.300 MINI



- Drainage.
- Scarico.
- Дренаж.

FINISHES	SAP	POINTS
Black matt lacquer	100287054	161

## DRAINAGE CHROME



- Drainage chrome.
- Scarico cromato.
- Дренаж хромированный.

FINISHES	SAP	POINTS
Chrome	100100505	281

## DRAINAGE

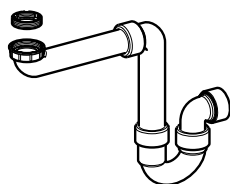

- Drainage.
- Scarico.
- Дренаж.

FINISHES	SAP	POINTS
Polypropylene	100138072	40

## DRAINAGE



- Drainage.
- Scarico.
- Дренаж.

FINISHES	SAP	POINTS
Polypropylene	100150474	30

## DRAINAGE



- Drainage.
- Scarico.
- Дренаж.

FINISHES	SAP	POINTS
Chrome	100190984	210

## DRAINAGE



- Drainage.
- Scarico.
- Дренаж.

FINISHES	SAP	POINTS
Black matt lacquer	100242315	255



# Warranty

## GAMA-DECOR BATHROOM FURNITURE GUARANTEE (V. 01/2012)

### Scope of the Guarantee:

This Manufacturer's Guarantee covers any claims for manufacturing defects affecting Gama-Decor brand furniture that are not visible during installation and which may appear with use or over time, for a period of THREE YEARS from the date of delivery to the first user, except in the case of consumable elements such as light bulbs, pistons, etc., for which Gama-Decor provides a guarantee of ONE YEAR. In the case of bathroom furnitures supplied for developments and building projects, the guarantee period will be calculated from the date on which the furnitures are supplied/certified.

This Guarantee does not cover the normal changes that affect wood, like any natural product, with the passing of time, as well as differences in its tone or grain.

During the period covered by this Guarantee, Gama-Decor reserves the right to modify the technical and design specifications of its products without prior notice. This Guarantee replaces any previous versions of the same.

### Guarantee Conditions:

-That the Gama-Decor bathroom furniture has been acquired from a certified distributor.

-That it has not undergone any alterations since it left the factory, and that all of its component features are respected.

-That any claims are not a result of causes beyond the control of Gama-Decor, such as leaks, overly high temperatures, abnormal humidity conditions, incorrect assembly, impacts, abusive or unsuitable use, unsuitable cleaning products, changes in tone due to exposure to sunlight, etc.

-That all recommendations regarding use and maintenance have been respected.

-That the products have not been use, nor displayed for an undefined period in any showrooms, trade fairs or exhibitions, in which case the guarantee period for these articles is 30 DAYS.

### Presentation of Claims:

Any fault identified in our products must be notified to the Certified Distributor who supplied or sold our products, or to a certified technical service provider. Any such notification must be made within a reasonable period of time from discovering the fault, in order to avoid any worsening of the situation. In any event, the execution and effective coverage of the guarantee offered for our products will be subject to an inspection carried out by the certified distributor who sold or supplied the products, or the certified provider of the supposedly faulty products.

In the event of Gama-Decor recognising that the affected element is faulty and within the limits of the Guarantee, it will propose either repairing or replacing the same, as applicable.

In these cases, Gama-Decor will provide the Distributor or technical service provider with:

-The materials that have had the original faults or defects repaired.

-New materials with identical characteristics, if Gama-Decor has opted to replace the faulty material, or if the repair is not satisfactory.

-In situations when the material in question is no longer available, it cannot be provided by our supplier, or the supplier has changed its activity, etc, Gama-Decor will offer an alternative solution.

NOTE: The Guarantee document will be applicable without prejudice to the rights of the consumer established by law in each country, as well as the Europe Community regulations.

# USA - Warranty

## GAMA-DECOR BATHROOM FURNITURE GUARANTEE (V. 01/2016)

### Scope of the Warranty:

This Manufacturer's Warranty covers any claims for manufacturing defects affecting GAMADECOR brand furniture that are not visible during installation and which may appear with use or over time, for a period of TWO YEARS from the date of delivery to the first user, except in the case of consumable elements such as light bulbs, pistons, etc., for which GAMADECOR provides a warranty of ONE YEAR. In the case of bathroom furniture supplied for developments and building projects, the warranty period will be calculated from the date on which the furniture are supplied/certified.

This Warranty does not cover the normal changes that affect wood, like any natural product, with the passing of time, as well as differences in its tone or grain.

During the period covered by this Warranty, GAMADECOR reserves the right to modify the technical and design specifications of its products without prior notice. This Warranty replaces any previous versions of the same.

### Warranty Conditions:

- That the GAMADECOR bathroom furniture has been acquired from a certified distributor.
- That it has not undergone any alterations since it left the factory, and that all of its component features are respected.
- That any claims are not a result of causes beyond the control of GAMADECOR, such as leaks, overly high temperatures, abnormal humidity conditions, incorrect assembly, impacts, abusive or unsuitable use, unsuitable cleaning products, changes in tone due to exposure to sunlight, etc.
- That all recommendations regarding use and maintenance have been respected.
- That the products have not been used, nor displayed for an undefined period in any showrooms, trade fairs or exhibitions, in which case the warranty period for these articles is 30 DAYS.

### Presentation of Claims:

Any fault identified in our products must be notified to the Certified Distributor who supplied or sold our products, or to a certified technical service provider. Any such notification must be made within a reasonable period of time from discovering the fault, in order to avoid any worsening of the situation. In any event, the execution and effective coverage of the warranty offered for our products will be subject to an inspection carried out by the certified distributor who sold or supplied the products, or the certified provider of the supposedly faulty products.

In the event GAMADECOR recognizes that the affected element is faulty and within the limits of the Warranty, it will propose either repairing or replacing the same, as applicable.

In these cases, GAMADECOR will provide the Distributor or technical service provider with:

- The materials that have had the original faults or defects repaired.
- New materials with identical characteristics, if GAMADECOR has opted to replace the faulty material, or if the repair is not satisfactory.
- In situations when the material in question is no longer available, it cannot be provided by our supplier, or the supplier has changed its activity, etc.

GAMADECOR will offer an alternative solution.

EXCEPT AS EXPRESSLY SET FORTH ABOVE, GAMADECOR MAKES NO WARRANTIES, EXPRESS OR IMPLIED, REGARDING ITS PRODUCTS, AND HEREBY DISCLAIMS ANY AND ALL IMPLIED WARRANTIES, INCLUDING WITHOUT LIMITATION ANY IMPLIED WARRANTIES OF MERCHANTABILITY OR FITNESS FOR A PARTICULAR PURPOSE.

To the maximum extent permitted by applicable law, GAMADECOR expressly excludes from this warranty, and will not pay for, any damages, including without limitation direct or indirect, consequential, special or punitive damages. This warranty extends only to the end user and is not transferable.

This warranty gives the end user specific legal rights, and he or she may also have other rights that vary from state to state. GAMADECOR will not be responsible for any statements or representations made in any form that go beyond, are broader than, or are inconsistent with any authorized literature or written specifications furnished by GAMADECOR. Some states do not allow limitations on how long an implied warranty lasts, or on special, incidental, or consequential damages. As a result, some of these limitations may not apply to the end user.

# Garanzia

## **GARANZIA MOBILI DA BAGNO GAMA-DECOR (V. 01/2012)**

### **Validità della Garanzia:**

Questa Garanzia del fabbricante copre qualsiasi possibile reclamo in caso di difetti di fabbricazione dei mobili a marchio Gama-Decor, non visibili durante l'installazione e che possano comparire con l'uso e con il passare del tempo per un periodo di TRE ANNI contato a partire dalla data di consegna al primo utente ad eccezione dei beni consumabili quali lampadine, pistoni, ecc... per i quali Gama-Decor offre una garanzia di UN ANNO. Nel caso di mobili forniti in promozione, cantiere, ecc... il periodo di garanzia si conterà a partire dalla data di fornitura/ certificazione degli stessi.

Sono esclusi dalla presente Garanzia i cambiamenti normali che il legno, come qualsiasi altro prodotto naturale, può subire con il passare del tempo quali le differenze di sfumature o venature dello stesso.

Durante la vigenza della presente garanzia, Gama-Decor si riserva la possibilità di modificare, senza previo avviso, le specifiche tecniche e riguardanti il design dei propri prodotti. La presente Garanzia annulla le precedenti versioni della stessa.

### **Clausole della Garanzia:**

-I mobili bagno Gama-Decor devono essere stati acquistati da un Distributore Ufficiale.

-Non devono essere state apportate modifiche una volta usciti i mobili di fabbrica. In ogni caso devono essere rispettate tutte le caratteristiche della composizione.

-Il reclamo non deve essere conseguenza di cause estranee a Gama-Decor, quali ad esempio infiltrazioni di acqua, temperature troppo elevate, condizioni di umidità anormali, difetti nel montaggio, colpi, uso improprio o non previsto, prodotti di pulizia non adeguati, cambi di tonalità dovuti a luce solare, ecc.

-Devono essere rispettate tutte le istruzioni riguardanti l'uso e la manutenzione

-I prodotti non devono essere stati usati o esposti durante un periodo indefinito in qualsiasi tipo di esposizione, dato che il periodo di garanzia di questi articoli è di 30 GIORNI.

### **Formalizzazione di un reclamo:**

Qualsiasi difetto incontrato nei nostri prodotti deve essere notificato al Distributore Ufficiale che ha fornito o venduto gli stessi o a un Centro Assistenza Tecnica Autorizzato. Tale comunicazione deve avvenire entro un periodo di tempo ragionevole dal momento in cui si rileva il difetto per evitare il possibile aggravarsi delle conseguenze dello stesso. In ogni caso, l'esecuzione e l'effettiva copertura della garanzia offerta ai nostri prodotti, è soggetta all'ispezione obbligatoria che il Distributore Ufficiale che ha eseguito la vendita o fornitura, o il Centro di assistenza tecnica devono effettuare sui prodotti indicati come difettosi.

Se Gama-Decor riconosce difettosa la parte interessata ed entro i termini di Garanzia proporrà la riparazione o sostituzione della stessa. In questi casi, Gama-Decor fornirà al Distributore o Centro di assistenza tecnica:

-I materiali riparati dai vizi o difetti originali

-Materiali nuovi con caratteristiche identiche, nel caso in cui Gama-Decor abbia ritenuto di sostituire il materiale difettoso o nel caso in cui la riparazione non fosse soddisfacente.

-Nei casi in cui, per mancanza dei materiali, impossibilità di fornitura da parte del nostro fornitore, cambio di attività del fornitore, ecc., Gama-Decor offrirà una soluzione alternativa.

NOTA: Il documento di garanzia si applica, fatti salvi i diritti dei consumatori ai sensi della legge vigente in ciascun paese, nonché secondo le disposizioni della normativa comunitaria europea.



# Гарантия

## GARANTIE MEUBLE DE SALLE DE BAINS GAMA-DECOR (V. 01/2012)

### Границы обязательств

Данная гарантия производителя распространяется на любые претензии, возникшие в связи с производственными дефектами, обнаруженными в мебели марки Gama-Decor, которые не были видны во время установки и которые, возможно, проявились в ходе использования или со временем, и действует в течение ТРИ ГОДА с даты поставки первому пользователю, за исключением расходных элементов, таких как лампочки, поршни и пр., на которые компания Gama-Decor дает гарантию сроком ОДИН ГОД. Если мебель для ванных комнат поставляется для девелоперских проектов или на стадии строительства здания, гарантийный период рассчитывается с даты поставки / сертификации предметов мебели.

Гарантийные обязательства не возникают в случае нормальных изменений, которым древесина как натуральный материал подвержена с течением времени, а также в случае несовпадений в ее оттенках или узоре.

В период действия данной гарантии компания Gama-Decor оставляет за собой право на внесение изменений в технические характеристики и дизайн своей продукции без предварительного уведомления. Данная редакция гарантийных обязательств заменяет все прежде действовавшие редакции.

### Условия гарантии

-Мебель Gama-Decor для ванной комнаты должна быть приобретена у сертифицированного дистрибьютора.

-Изделия не подвергались никаким изменениям, с тех пор как покинули завод-изготовитель, все характеристики компонентов мебели учтены.

-Предъявленные претензии не являются результатом причин, находящихся вне сферы контроля Gama-Decor, таких как протечки, сверхвысокие температуры, аномальная влажность, неправильная установка, удары, ненадлежащая эксплуатация, использование неподходящих моющих средств, изменения тона вследствие воздействия солнечных лучей и т. д.

-Все рекомендации по эксплуатации и обслуживанию соблюдены.

-Изделия не использовались и не демонстрировались в течение неопределенного периода времени в демонстрационных залах, на промышленных ярмарках или выставках. В противном случае гарантийный период на такие изделия составляет 30 (тридцать) ДНЕЙ.

### Подача претензий

О любом дефекте, обнаруженном в наших изделиях, необходимо уведомить сертифицированного дистрибьютора, который занимается поставками или продажами наших товаров, или сертифицированную службу технической поддержки. Такое уведомление должно быть оформлено в течение разумного периода с момента обнаружения дефекта, чтобы избежать ухудшения ситуации. В любом случае условием выполнения и эффективного покрытия гарантийных обязательств в отношении нашей продукции является проверка, которую проводит сертифицированный дистрибьютор, осуществивший продажу или поставку этой продукции, или сертифицированный поставщик продукции, предположительно имеющей дефекты.

Если компания Gama-Decor подтвердит, что рассматриваемый элемент содержит дефект, на который распространяются гарантийные обязательства, клиенту, в зависимости от обстоятельств, будет предложен ремонт или замена этого элемента.

В этих случаях компания Gama-Decor предоставит дистрибьютору или службе технической поддержки

-материалы с устраненными или исправленными дефектами;

-новые материалы, идентичные по своим характеристикам, если компания Gama-Decor приняла решение заменить дефектный материал или если ремонт является неудовлетворительной мерой;

-если рассматриваемый материал отсутствует и более не может быть предоставлен поставщиком или если поставщик сменил сферу деятельности и пр., компания Gama-Decor предложит альтернативное решение.

**ПРИМЕЧАНИЕ** Данный гарантийный документ применяется без ограничения прав потребителей, установленных действующим законом каждой страны, а также законодательством Европейского союза.

**GAMADecor**  
PORCELANOSA Grupo





**GAMADecor**  
PORCELANOSA Grupo



The mark of  
responsible forestry  
FSC® C115389



2022-TARIFA BAÑO-01/22

© Copyright GAMA-DECOR, S.A.U. All rights reserved.

GAMADecor reserves the right to modify or cancel the information that appears in this catalogue concerning all aesthetic and technical aspects as well as pricing. GAMADecor reserves the right to modify the characteristics of its products without prior notice. The finishes shown are only for informative purposes; all rights are reserved due to the possible differences resulting from printing. For that reason, the photos displayed of de products are not to be deemed contractually binding. All rights are reserved for possible errors within the texts which appear in the catalogue due to the computation or insertion of the pages. This catalogue is informative only.

© Copyright GAMA-DECOR, S.A.U. Tutti i diritti riservati.

GAMADecor si riserva il diritto di modificare, alterare, eliminare o aggiungere informazioni a questo catalogo a livello estetico, tecnico ed economico. GAMADecor si riserva il diritto di modificare le caratteristiche dei prodotti senza preavviso di alcun tipo. Le finiture sono espresse a titolo indicativo, essendo possibili variazioni di colore dovute alla tecnica di stampa. Per questo, le foto dei prodotti esposti non sono oggetto di contratto. I testi che compaiono nel catalogo potrebbero presentare errori di composizione o inserimento nella pagina. Tale catalogo è puramente informativo.

© Copyright GAMA-DECOR, S.A.U. Все права сохранены.

Компания GAMADecor оставляет за собой право на внесение изменений или изъятие информации, содержащейся в данном каталоге и относящейся к эстетическим и техническим аспектам продукции, а также к ценам. Компания GAMADecor оставляет за собой право на внесение изменений в характеристики продукции без предварительного уведомления. Варианты отделки приведены только для информирования; за компанией сохраняются все права в сфере возможных споров, связанных с различиями в цветопередаче при печати. По этой причине фотоизображения изделий не могут иметь обязательную силу в рамках контракта. Сохраняются все права, связанные с возможными ошибками в тексте каталога или компоновке страниц. Данный каталог предназначен только для информирования.

[www.gama-decor.com](http://www.gama-decor.com)

**GAMADecor**  
PORCELANOSA Grupo

GAMA-DECOR, S.A.U. Ctra. Vila-real - Puebla de Arenoso (CV-20) Km. 1,7.  
12540 Vila-real, Castellón, España. Apdo. Correos 179.  
Teléfono (+34) 964 506 850 Fax nacional: (+34) 964 506 596 Fax exportación: (+34) 964 506 597  
e-mail: [gama-decor@gama-decor.com](mailto:gama-decor@gama-decor.com) · [www.gama-decor.com](http://www.gama-decor.com)